

**MODEL 910**  
**OPERATOR'S MANUAL**

# **MODEL 910 OPERATOR'S MANUAL**

**TeleVideo No. B30000 3-001**  
**Copyright TeleVideo Systems, Inc.**  
**May 1981**

**Specifications and Information Subject to Change  
Without Prior Notification**

**“Warning:** This equipment generates, uses, and can radiate radio frequency energy, and if not installed and used in accordance with the instruction manual may cause interference to radio communications. As temporarily permitted by regulation, it has not been tested for compliance with the limits for Class A computing devices pursuant to Subpart J of Part 15 of FCC Rules, which are designed to provide reasonable protection against such interference. Operation of this equipment in a residential area is likely to cause interference, in which case the user at his own expense will be required to take whatever measures may be required to correct the interference.”

# WARRANTY POLICY AND RETURNED MATERIAL PROCEDURE

## Warranty

TeleVideo warrants that its products will be free from defects in material and workmanship for a period of three (3) months from the date of shipment from the factory. If you receive a terminal that has been damaged in shipment, contact your carrier and process a claim.

## Service Under Warranty

If you have any technical problems with your terminal, feel free to call our Customer Service Department. If your unit should happen to malfunction during the three-month warranty period, please notify your Distributor. Your Distributor may repair the terminal or determine that it must be returned to TeleVideo.

## RMA and Shipping

If it's necessary to return the terminal to TeleVideo, your Distributor will give you a Return Material Authorization (RMA). All communications regarding the terminal should reference this RMA number.

The terminal is to be shipped to TeleVideo at your expense. (See Chapter 2 for packing instructions.) TeleVideo will repair the terminal at no cost to you and pay for shipping it back via UPS surface. Any other method, such as air express, will be at your expense. Normal turnaround time is three days plus transportation time.

## Service Out of Warranty

If your terminal is out of warranty when it needs service, you should follow the same procedure to receive an RMA. You will be responsible for all shipping costs.

Should your company require a purchase order for out-of-warranty repairs, let us know the purchase order number when you call in. One purchase order may cover several repairs but we will give each item its own individual RMA number. This allows us to return each item quickly and not hold up the entire purchase order because of one item.

## Technical Assistance

The Service Department is open from 6:30 a.m. until 5:30 p.m., Pacific Time, continuously, Monday through Friday. If the line is busy and your problem can wait, leave a message with the TeleVideo operator and your call will be returned at our first opportunity.

Be specific when describing the problem and failure history. The problem will be solved much quicker when described in a calm, accurate manner.

## Extended Warranty

TeleVideo offers an Extended Warranty Contract. To take advantage of this Extended Warranty, you must sign the Extended Warranty Contract and return it, together with full payment, to TeleVideo prior to the end of your normal warranty period. The extended warranty lasts for one year; the cost is \$75.00.

To renew the extended warranty for another year, the same procedure must be followed.

Shipping charges are *not* included in the Extended Warranty. This is the only expense you incur.

## Serial Number

Your terminal's serial number is on the rear of the terminal, date-coded as follows:

Model	910	Yr.	Mo.	No.
	6	x	xx	xxxx

## Vital Statistics

When you receive your terminal, enter here the serial number, date received, and switch settings. This will expedite any technical conversations about your terminal.

Serial Number 401 4161

Date Received 3-1-68

Switch Settings Used:

(Enter U or D for Up or Down)	S1	U/D	S2	U/D
		1 <u>-</u>		1 <u>-</u>
		2 <u>-</u>		2 <u>-</u>
		3 <u>-</u>		3 <u>-</u>
		4 <u>U</u>		4 <u>-</u>
		5 <u>U</u>		5 <u>-</u>
		6 <u>U</u>		6 <u>-</u>
		7 <u>U</u>		7 <u>-</u>
		8 <u>U</u>		8 <u>U</u>
		9 <u>U</u>		9 <u>U</u>
		10 <u>U</u>		10 <u>U</u>

# SPECIFICATIONS

## MONITOR

Size: 12" measured diagonally  
Phosphor: P4, nonglare read-out

## DISPLAYED CHARACTER SET

128 displayable characters  
(96-character ASCII upper/lower case alphabet with true descenders plus 32 control characters)  
24 lines  
80 characters per line  
1920 characters per screen  
Video attributes  
Blinking fields  
Security (blank) fields  
Reverse video  
Underlined fields  
Half intensity

## CHARACTER SETS

English, French, German, Spanish

## CHARACTER FONT

7 X 8 dot matrix  
8 X 10 resolution

## KEYBOARD FORMAT

Tab, Back tab

## REPEAT

20-cps auto-repeat

## EDITING FEATURES

Typeover  
Clear screen to space or null  
Erase to end of page  
Erase to end of line  
Absolute cursor addressing

## CURSOR CONTROLS

↓, ↑, →, ←, Home, Tab, Back Tab, Return, Line Feed, Backspace

## PARITY

Even, Odd, Send, or No Parity

## TRANSMISSION

Conversation mode: Full or half duplex

## BAUD RATES

15 baud rates:  
50, 75, 110, 135, 150, 300, 600, 1200, 1800, 2400, 3600, 4800, 7200, 9600, 19,200

## INTERFACES

Standard RS232C point-to-point (50 ft. max.)  
20ma current loop (optional) (1000 ft. max.)  
RS232C printer port (unidirectional)

## EMULATION

ADDS 25  
Hazeltine 1410  
Lear Siegler ADM-3A/5

## DIMENSIONS

Height: 13¼" (33.66 cm)  
Width: 16⅞" (40.96 cm)  
Depth: 20⅞" (50.96 cm)

## VENTILATION REQUIREMENTS

Minimum 4" (10.2 cm)

## WEIGHT

30 lbs. (13.95 kg)

## OPERATING ENVIRONMENT

Ambient temperature range:  
0°C to 50°C (32°F to 122°F)  
Maximum relative humidity (noncondensing): 95%

## POWER REQUIREMENTS

115 VAC at 0.5 amp  
230 VAC at 0.25 amp  
50/60 Hz, 55W

# TABLE OF CONTENTS

<b>WARRANTY POLICY AND RETURNED MATERIAL PROCEDURE</b> .....	iii
--	-----

<b>SPECIFICATIONS</b> .....	v
-----------------------------	---

<b>1. INTRODUCTION</b> .....	1
Description of Manual .....	1
How to Use This Manual .....	1
Description of Terminal .....	1
Protect Yourself! .....	1
Protect the Terminal .....	2
<b>2. INSTALLATION</b> .....	2
Introduction .....	2
Unpacking and Inspecting the Terminal .....	2
Preparing the Site .....	3
Installation .....	3
Checking Your Installation .....	8
<b>3. OPERATION</b> .....	8
Introduction .....	8
Turning on the Terminal .....	8
Keyboard Controls .....	9
Basic Operations .....	12
<b>4. PROGRAMMING</b> .....	12
Introduction .....	12
Monitoring Control Commands .....	13
Control Functions .....	13
FUNCT Key .....	13
Addressing the Cursor .....	13
Auto Scroll .....	14
Visual Attributes .....	14
Enabling/Disabling the Printer .....	14
Disabling the Keyboard .....	15
Word Structure, Parity Settings, and Stop Bits ..	15
Custom RAM and ROM Applications .....	16
Cursor Appearance/Disappearance .....	16
Bell .....	16
<b>5. PREVENTIVE MAINTENANCE</b> .....	16
Care .....	16
<b>6. TROUBLESHOOTING AND REPAIR</b> .....	16
Troubleshooting .....	16
Repair .....	17

## APPENDICES

A. Summary of Functional Commands .....	20
B. Cursor Coordinates .....	23
C. ADDS Cursor Coordinates .....	24
D. ASCII Code Chart .....	24

<b>INDEX</b> .....	25
--------------------	----

<b>GLOSSARY</b> .....	26
-----------------------	----

## OPERATOR'S QUICK REFERENCE GUIDE

### TABLES

Table 2-1—P3 (Computer Interface) Connector .....	3
Table 2-2—Serial Interface (P4) Pin Connections (Printer) .....	3
Table 2-3—Switch Settings for Model 910 .....	4
Table 2-4—Switch Settings of S1 for Common Word Structures .....	7
Table 2-5—RS232C Terminal Interface Jumper Options .....	5
Table 2-6—Character Set Jumper Options .....	8
Table 2-7—Composite Video Jumper Option .....	8
Table 3-1—Function of Keys .....	10
Table 4-1—Function Key Commands .....	13
Table 4-2—Escape Sequences for Visual Attributes .....	14
Table 4-3—Switch Settings for Parity and Data Bits .....	16
Table 6-1—Troubleshooting Terminal Problems .....	17
Table A-1—Summary of Functional Commands .....	20
Table B-1—Cursor Coordinates .....	23
Table C-1—ADDS Cursor Coordinates .....	24
Table D-1—ASCII Code Chart .....	24

### FIGURES

Figure 2-1—Model 910 Dimensions .....	4
Figure 2-2—Rear Panel .....	4
Figure 2-3—Logic Board .....	5
Figure 2-4—Interior of Terminal .....	6
Figure 2-5—Switch Setting Examples .....	7
Figure 3-1—Model 910 Keyboard Layout .....	9
Figure 3-2—Model 910 Communications Flow .....	9
Figure 4-1—Model 910 Video Attributes and Monitor Mode .....	15
Figure 4-2—Bit Structure of a Serial Data Word ..	15

# 1. INTRODUCTION

## 1.1 DESCRIPTION OF MANUAL

This manual will teach you how to install, operate, program, and troubleshoot your new terminal. The manual has been designed to help you use the terminal easily regardless of your previous experience with terminals. As you progress through the manual, you will find the following chapters:

### 2. Installation

Setting up your site for the terminal, the power requirements, unpacking and checking the terminal, setting switches to take advantage of the options available, configuring the terminal for your computer system and printer.

### 3. Operation

Turning on the terminal, a description of the keyboard and functions of the keys, using tabs, editing, sending data to the computer and the printer.

### 4. Programming

Controlling the terminal through commands from your computer system: programming special functions, setting visual attributes, monitoring the program, loading and reading the cursor position, adding custom RAM and ROM, using Auto Scroll, disabling the keyboard and printer.

### 5. Preventive Maintenance

Periodic cleaning and inspection of the terminal.

### 6. Troubleshooting and Repair

Troubleshooting simple problems (using a table of symptoms, possible causes, and solutions), using self-test.

### Glossary

Explanation of terms commonly used in this manual.

### Appendices

Reference tables.

### Index

References to main subsections by subject.

## 1.2 HOW TO USE THIS MANUAL

Each subsection of the manual is numbered. To find a topic later, look in the index and find the appropriate subsection.

As you read the manual, you will notice some special symbols at the left margin of the text. These symbols call your attention to information of special importance. The symbols used are:



General note giving information to every operator.

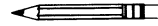

Programming note giving information of special significance to the programmer.



Warning giving information concerning the safety of the operator or possible loss of data. **When you see this note, STOP and read the note before proceeding!**

Emulation commands are given in Table A-1 and the Operator's Quick Reference Guide. The descriptive text of the manual **will only reference the 910 commands.**

On the back cover is the Operator's Quick Reference Guide, listing all control and escape commands for the terminal.

## 1.3 DESCRIPTION OF TERMINAL

A brief overview of the capabilities of your terminal will help you take advantage of its features as you use it. The Model 910 operates in a conversation mode with your computer system, in either half or full duplex. Baud rates can be set at any of 15 speeds, from 50 to 19,200.

Depending on switch settings, the 910 will emulate a Lear Siegler ADM-3A/5, a Hazeltine 1410, or an ADDS 25. Character sets can be changed to English, Spanish, German, or French. Visual attributes can be set a line at a time, either alone or in combination. You can set the display to monitor the computer program (to facilitate program debugging).

Printing is easily controlled with a special PRINT key. Using the FUNCT key with a numeric key allows you to quickly transmit one of ten special command code sequences. To create custom applications, you can easily substitute a ROM with twice as much space. Termination characters are switch selectable. The keyboard is a Selectric style and includes a ten-key pad for easy entry of numbers.

## 1.4 PROTECT YOURSELF!

When you install or test the terminal, observe standard safety precautions (as you would with any electrical or electronic equipment). Only qualified service personnel should open the terminal housing. Disconnect all power before performing any inspection or maintenance.



Beyond the normal precautions, you should be aware of two additional conditions:

1. If the CRT tube should be broken, always wear heavy rubber gloves or use tongs to pick up the broken CRT fragments since the coating on the inside of the tube is poisonous.

2. Even after the power is turned off, charges are retained by the CRT and capacitors. Always discharge them to ground before touching them. Never reach into the terminal enclosure unless someone capable of giving aid is present.

## 1.5 PROTECT THE TERMINAL

Although the terminal is packaged in a durable housing, you can help protect it by observing two simple precautions:

1. Take care to keep foreign objects such as paper clips or liquids off the keyboard.
2. Use the terminal on a secure surface and don't drop the terminal or drop heavy objects onto it.

# 2. INSTALLATION

## 2.1 INTRODUCTION

This chapter will tell you how to unpack and check your terminal for damage, check power and site requirements, and set the power and interface configurations. A brief checklist at the end will make sure you did not skip any part of the installation process.

Once your terminal is installed, you will be ready to operate the terminal and you will probably not need to use this chapter again unless you need to move the terminal, reship it, or use it with another computer system.

As you start the installation, you will want to have some information about your computer system and its configuration requirements.

## 2.2 UNPACKING AND INSPECTING THE TERMINAL

### 2.2.1 Shipping Damage Inspection

After the terminal is delivered to you, inspect the shipping container as well as the terminal (inside and out) for damage before taking it to your installation site. You should inspect the container for obvious damage before accepting delivery of the terminal. If damage is found, note it on the waybill and require the delivery agent to sign the waybill. Notify the transfer company immediately and submit a damage report to the carrier, your dealer, and to TeleVideo. If no exterior damage is found, unpack the terminal and inspect it for hidden damage.

### 2.2.2 Unpacking the Terminal

Carefully unpack the terminal from the shipping container. Avoid using sharp instruments to open the container. Save the packing material for possible use in reshipping the terminal.

### 2.2.3 Inspecting the Terminal

After you unpack the terminal, inspect it thoroughly for hidden damage and loose components or fittings. The inspection checklist is as follows:

1. Remove the terminal cover by removing the screws underneath the front bottom of the keyboard. Lift up the cover carefully.



The terminal will now be top heavy and will have a tendency to fall over backwards. Be sure there is sufficient table room.

2. Inspect the keyboard and display cabinet interior for shipping damage.
3. Examine cable harnesses for stress, loose or broken wires, or broken cable ties.
4. Examine all internally mounted components for loose or missing hardware.
5. Tighten all loose hardware.
6. Clean loose debris from the cabinet interior.
7. Replace the cover. Do not overtighten the screws.

### 2.2.4 Reporting Damage

If hidden damage is found, immediately notify the transfer company of the damage. Save all packing materials for the transfer company's inspection, file a damage report with the carrier, and notify your dealer and TeleVideo of the damage. Since terms of sale for the terminal are FOB TeleVideo, Sunnyvale, California, TeleVideo is not responsible for any damage which occurred during shipment and will not repair this damage under warranty. **All repairs for shipping damage are billable.** Prompt notification of damage will ensure claim validity and expedite payment for necessary repairs by the transfer company or its insurance agent.

### 2.2.5 Reshipping the Terminal

Should you need to reship the terminal, follow these procedures:

1. Remove the two screws on the bottom front of the terminal and lift off the cover.
2. Check the integrity of the cabling and security of internal mounting hardware.
3. Replace cover, being careful not to overtighten the screws.
4. Repack the terminal in the original TeleVideo shipping container or other suitable materials.



## 2.3 PREPARING THE SITE

Before you proceed with the actual installation, make sure you are ready with the proper power and a large enough table.

### 2.3.1 Power Requirements

- 115 VAC 60 Hertz at 0.5 amp  
OR  
230 VAC 50 Hertz at 0.25 amp
- 55 watts
- NEMA standard 5-15R, 3-prong receptacle (US only)

### 2.3.2 Physical Requirements

- Flat, level area
- Surface dimensions: 13¼ inches (33.66 cm) high  
16⅞ inches (40.96 cm) wide  
20⅙ inches (50.96 cm) deep
- Recommended ventilation clearance is 4 inches (10.2 cm) on all sides. Refer to Figure 2-1.

## 2.4 INSTALLATION

The actual installation and set-up consists of only three steps:

1. Configuring the terminal for either 115 or 230 VAC operation.
2. Configuring and connecting the terminal to the computer and printer connectors.
3. Setting up the terminal's operating switches and jumper options.

These procedures should only be performed by technically qualified personnel.

### 2.4.1 Power Configuration

Depending on your location, the terminal can be configured to operate with either 115 VAC (United States) or 230 VAC (international).

**115 VAC Configuration**—Keep the three-prong plug which is provided with the terminal and make sure your outlet is grounded. If an adapter is used, ground with a pigtail.

**230 VAC Configuration**—If you are located outside the United States and use 230 VAC power, cut off the US-style three-prong plug provided and install a connector compatible with your local power receptacles. The power cord wires are color-coded as follows:

- Green           Earth ground
- Black           Primary power (hot)
- White           Primary power return (neutral)

**Setting Power Select Switch**—Set the power select switch on the bottom of the terminal to either 115V or 230V. ( **A** on Figure 2-2). You will set Hertz to match your power frequency when you set S2 (Table 2-3).

### 2.4.2 Connecting the Terminal to Your Computer System

You can connect the terminal directly to your computer system or use a modem. Table 2-1 points out pin connections which are always used for either the computer connection or to a modem.

**Interfacing Connections**—The interface connection to the computer system (main) port is P3, located on the rear of the terminal ( **B** in Figure 2-2). The connector configuration of P3 is given in Table 2-1.

**TABLE 2-1  
P3 (COMPUTER INTERFACE)  
CONNECTOR**

		Minimum Communication Link		
Computer	Modem	Pin No.	Signal Name	
		1	Frame Ground	
x	x	2	Transmit Data (OUTPUT)	
x	x	3	Receive Data (INPUT)	
		4	Request to Send (OUTPUT)	
		5	Clear to Send (INPUT)	
		6	Data Set Ready (INPUT)	
x	x	7	Signal Ground	
	x	8	Carrier Detect (INPUT)	
		20	Data Terminal Ready (OUTPUT)	

**TABLE 2-2  
SERIAL PRINTER INTERFACE (P4) PIN  
CONNECTIONS**

Pin No.	Signal Functional Name
1	Frame Ground
3	Transmit Serial Data (RS232) OUTPUT
7	Signal Ground
20	Printer Ready INPUT

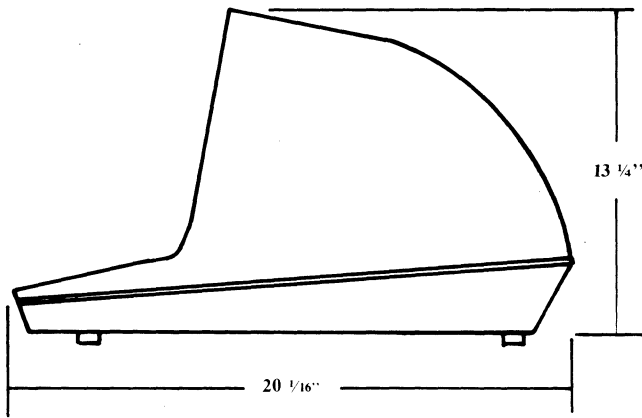

Figure 2-1 Model 910 Dimensions

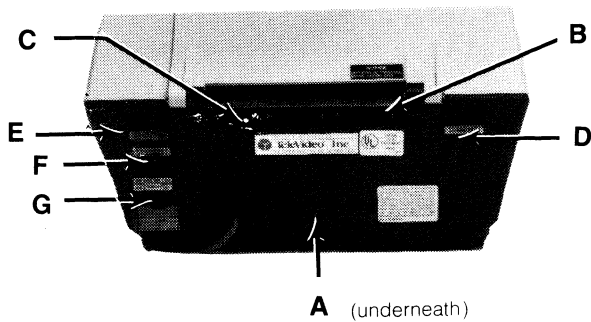

Figure 2-2 Rear Panel

TABLE 2-3  
SWITCH SETTINGS FOR MODEL 910<sup>1</sup>

(Reference EIA Standard RS232 for Signal Definitions)

Switch	Position				Baud Rate Setting
	1	2	3	4	
S1	D	D	D	D	9600
	D	D	D	U	50
	D	D	U	D	75
	D	D	U	U	110
	D	U	D	D	135
	D	U	D	U	150
	D	U	U	D	300
	D	U	U	U	600
	U	D	D	D	1200
	U	D	D	U	1800
	U	D	U	D	2400
	U	D	U	U	3600
	U	U	D	D	4800
	U	U	D	U	7200
	U	U	U	D	9600
	U	U	U	U	19200

Legend: U = Up  
D = Down

NOTES

1. After you set switches, complete the table on page iv; this will provide a quick reference later.
2. Set to match powerline frequency to avoid screen flicker.

Toggle Setting

Switch	Position	Up	Down	Description	
S1	5	x		7-bit word structure	
			x	8-bit word structure	
	6	x		Send parity	
			x	No parity	
	7	x		Even parity	
			x	Odd parity	
	8	x		2 stop bits	
			x	1 stop bit	
	9	x		Auto wraparound at the 80th character	
			x	No wraparound. Cursor stays in 80th position.	
10	x		CR code perform CRLF		
		x	CR code performs only a CR		
S2	1		x	Standard 910	
		2	x		
	1	x		x	Emulates ADM-3A/5
			2	x	
	1	x		x	Emulates ADDS 25
			2	x	
	1	x		x	Emulates Hazeltine 1410
			2	x	
	3			x	60 Hertz frequency <sup>2</sup>
			x		50 Hertz frequency <sup>2</sup>
4			x	Blinking block cursor	
		5	x		
4			x	Blinking underline cursor	
		5	x		
4	x		x	Steady block cursor	
		5	x		
4	x		x	Steady underline cursor	
		5	x		
6	x			Full duplex	
			x	Half duplex	
7	x			White characters on black screen	
			x	Black characters on white screen	
8	x			Data Set Ready disconnected (P3, pin 6)	
			x	Data Set Ready connected	
9	x			Data Carrier Detect disconnected (P3, pin 8)	
			x	Data Carrier Detect connected	
10			x	Data Terminal Ready connected	
		x		Data Terminal Ready disconnected	



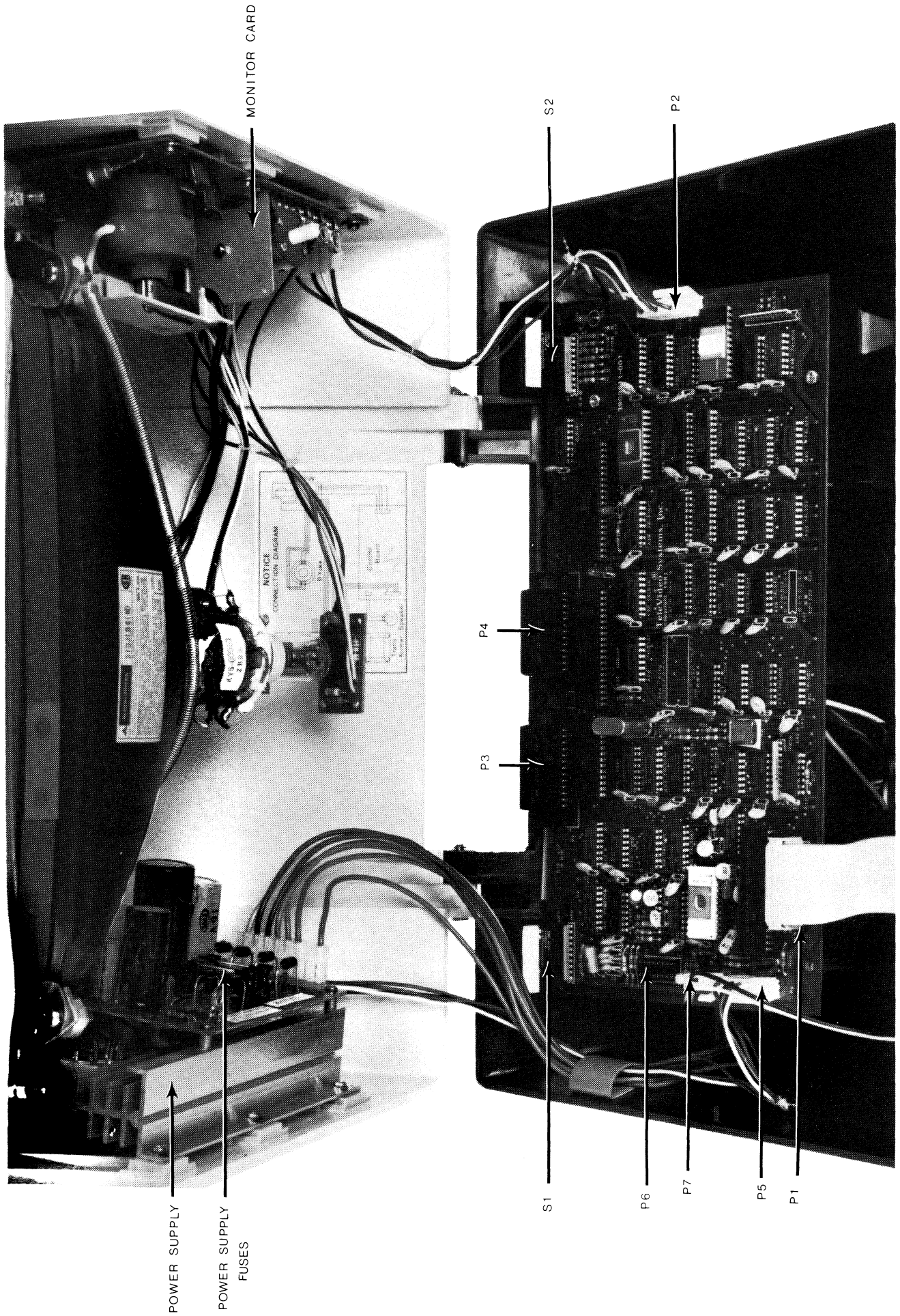

Figure 2-4 Interior of Terminal

**TABLE 2-4**  
**SWITCH SETTINGS OF S1 FOR COMMON**  
**WORD STRUCTURES**

(Data Bits, Stop Bits, and Parity)

	Position					
5	6	7	8	Data Bits	Parity	Stop Bits
U	D	X	D	7	None	1
U	D	X	U	7	None	2
U	U	D	D	7	Odd	1
U	U	D	U	7	Odd	2
U	U	U	D	7	Even	1
U	U	U	U	7	Even	2
D	D	X	D	8	None	1
D	U	D	D	8	Odd	1
D	U	U	D	8	Even	1

**Legend:** U = Up  
D = Down  
X = Either up or down

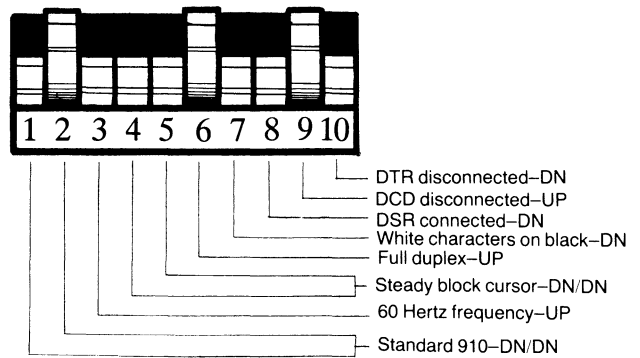

**Figure 2-5 Switch Setting Examples**

**TABLE 2-5**  
**RS232C TERMINAL INTERFACE JUMPER**  
**OPTIONS**

1. **Standard set up (no modifications to printed circuit board)**
  - a. Data Carrier Detect (DCD), P3 pin 8, is used to monitor status of an external modem.
  - b. Data Terminal Ready (DTR) output is sent to the computer when DTR from printer port is received.

**2. Jumper Options**

- a. Data Set Ready (DSR), P3 pin 6, can be used to monitor the external modem rather than DCD.

**Implementation:** Cut trace between E14 and E15

Add jumper from E16 to E15

- b. Use Request to Send (RTS) to send DTR to computer rather than DTR from printer.

**Implementation:** Cut trace between E18 and E19

Add jumper from E17 to E19

(Refer to Figure 2-3)

**Hertz**

You can set the Hertz switch to match your powerline frequency. (Table 2-3)

**Parity**  
**Stop Bits**

**Word Structure**

You can set the parity, number of stop bits, and number of bits in the word structure to match the requirements of your computer system. (Tables 2-3 and 2-4)

**Signals**

You can connect/disconnect Data Set Ready, Data Carrier Detect, and Data Terminal Ready. (Tables 2-3 and 2-4)

**2.4.3 Interfacing to a Printer**

Your terminal can be connected to an auxiliary serial printer to make a permanent hard copy of data displayed on the screen. The terminal's serial printer interface allows the terminal to be used with most RS232-compatible serial printers currently available on the market, including both character-by-character and buffered printers. The serial printer interface is a 25-pin connector, P4, located on the rear of the terminal. (See [C] in Figure 2-2.) Table 2-2 defines the printer interface pin connections.

**2.4.4 Configuring the Terminal for the Computer and Printer**

Several switches, located at the rear and internally, allow you to configure the terminal to operate according to the requirements of your computer system and printer. This section lists all possible switch settings (in table form).

Setting the switches as shown in Table 2-3 allows you to preset the terminal to operate in any of several optional conditions:

**Baud Rates**

You can select any of 15 baud rates according to the requirements of your computer system. (Tables 2-3 and 2-4)

**Character Sets**

You can select English, French, German, or Spanish character sets (using jumper options). (Tables 2-3 and 2-6)

**Conversation**

You can select half or full duplex.

**Emulations**

You can set the terminal to emulate another brand of terminal (ADDS 25, Hazeltine 1410, or Lear Siegler ADM-3A/5. (Table 2-3)

## TABLE 2-6 CHARACTER SET JUMPER OPTIONS

The 910 has four possible character sets. The standard set is English. To select another character set:

- French** Cut trace between E4 and E5. Ensure that E6 and E7 are connected.
- German** Cut trace between E6 and E7. Ensure that E4 and E5 are connected.
- Spanish** Cut trace between E6 and E7 and E4 and E5.

## TABLE 2-7 COMPOSITE VIDEO JUMPER OPTION

To drive a monitor other than (or in addition to) the terminal monitor, you can modify P2 pin 6. BNC center lead to P2 pin 6 (video). BNC ground lead to P2 pin 3.

- Implementation:** Cut trace between E10 and E11  
Add jumper between E12 and E13

### Video Display

You can set the display of the terminal to be white on black or black on white, with a steady or blinking cursor which is either an underline or a block. (Table 2-3)



Whenever you change any switches, reset the terminal by turning the power off and then back on or pressing SHIFT/BREAK keys to allow the software to scan all of the new switch positions.

S1 and S2 are accessible from the rear of the terminal (see Fig. 2-3).

## 2.5 CHECKING YOUR INSTALLATION

Before you proceed to the next chapter and turn on the terminal, check to be sure you installed the terminal correctly.

1. Did you install the correct power plug for your wall outlet?
2. Did you set the power selector switch to match your power requirements?
3. Is the main interface cable to the computer system properly wired and plugged in?
4. If you are using a printer, did you plug in the printer interface connector?
5. Did you set the switches for the correct
  - baud rate (both for terminal and printer)?
  - stop bits?
  - word structure?
  - parity?

6. Did you set switches for
  - 50 or 60 Hertz (to match your powerline/frequency requirements)?
  - full or half duplex?
7. Did you plug the terminal in to the wall outlet?

If the answer to all of these steps is YES, then you are ready to proceed with actually using the terminal.

# 3. OPERATION

## 3.1 INTRODUCTION

This chapter will lead you step-by-step through the operation of the terminal. Even if you have never used a computer terminal before, you will be able to use the terminal easily if you read this chapter carefully. If you are a programmer, you will want to continue on to Chapter 4, which covers additional information for programming a computer to interface with your terminal.



During this chapter you will learn about:

- Turning on and adjusting the terminal's display screen
- Using the various keys on the keyboard
- Directing data to the computer system and the printer
- Setting tabs
- Changing visual attributes of the screen
- Communicating with your computer system

## 3.2 TURNING ON THE TERMINAL

### 3.2.1 Rear Controls

Several controls are located at the rear of the terminal.

- Baud rate switches (S1) (  in Figure 2-2)
- Function switches (S2) (  in Figure 2-2)

Set these prior to turning on power to the terminal (as explained in Chapter 2) and keep a permanent record on page iv of how you have set the switches.

The connectors to the main interface and printer ports are also located here.

Once these have been set during installation, they will seldom need to be changed unless the terminal is being used with several different computer systems.

### 3.2.2 Turning On and Adjusting the Terminal

Turn on the terminal as follows:

1. Make sure the ON/OFF switch at the back of the terminal ( **G** in Figure 2-2) is OFF.
2. Plug the terminal cord into a grounded outlet (115 VAC in United States).
3. Push the end of the rocker power switch marked with a white dot. The terminal should beep within one second, indicating that power is on and the CPU has initialized the terminal. After another 10 to 15 seconds, the cursor should appear in the upper left corner of the screen (HOME).
4. If the cursor does not appear at the HOME position, press the HOME key on the keyboard. If the cursor still does not appear, check the contrast control at the rear of the terminal ( **F** in Figure 2-2).
5. Adjust the contrast control for the desired screen intensity.
6. Follow the sign-on protocol required by your computer system.
7. See Chapter 6, Troubleshooting and Repair, for help if the installation does not proceed smoothly.

### 3.3 KEYBOARD CONTROLS

In addition to standard alphanumeric typewriter keys, your terminal has several keys which perform special operations. These special keys can be used in conjunction with your computer to allow:

- Modifying action of other keys
- Editing
- Entering preprogrammed data

Each key on the keyboard is actually a switch. Sometimes two keys can be used together to provide a totally different message to the computer (CTRL or SHIFT). When used together, these keys control the generation of data sent to the computer system and the receipt and printing of information.

#### 3.3.1 Keyboard Layout

Figure 3-1 illustrates the keyboard layout. Refer to Table 3-1, where each key's function is described in detail. This table is subdivided by types of functions and gives information on the effect of each key and commands. For detailed information, refer to Table A-1 in the Appendix.

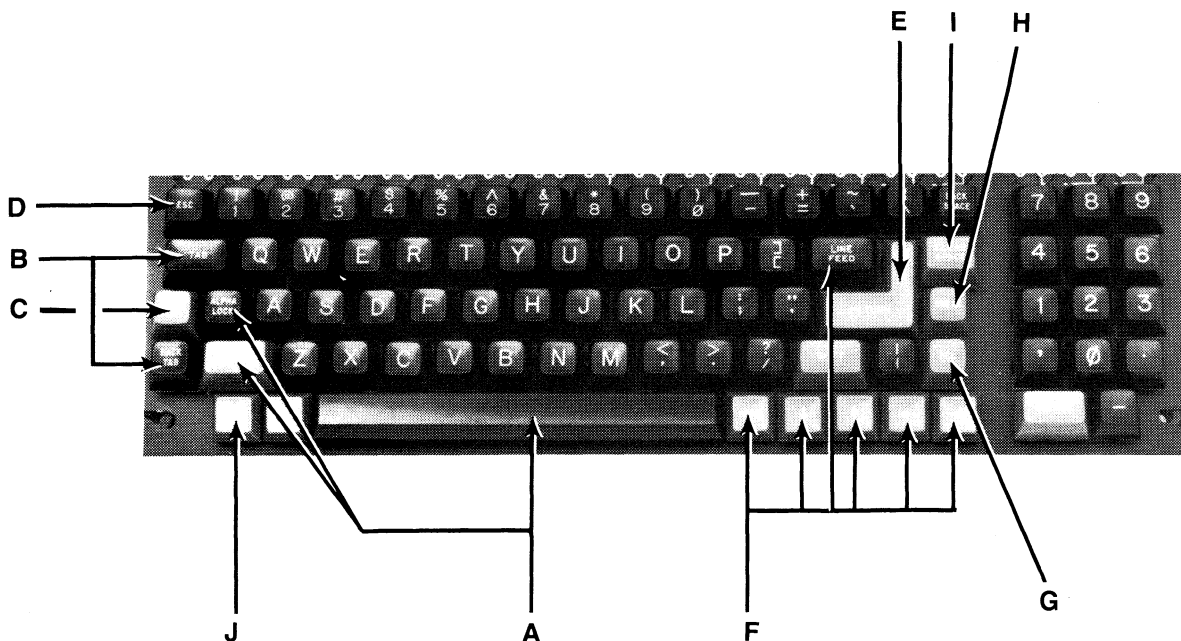





Figure 3-1 Model 910 Keyboard Layout

**TABLE 3-1  
FUNCTION OF KEYS<sup>1</sup>**

Key Name	Area <sup>2</sup>	Transmitted? (Yes/No)	Repeat Action? (Yes/No)	General Function
Space Bar	A	Y	Y	Causes a blank space to appear on the display and transmits an ASCII space code.
SHIFT	A	N	N	Selects upper character indicated on another key and changes operation of special keys.
				 Commands which require simultaneous depression of two keys are indicated by a slash.
ALPHA LOCK	A	N	N	Locks upper case for alpha characters only; has no effect on numeric or special keys. The key is pressed to lock and pressed again to release.
TAB	B	Y	Y	Moves cursor to next tab location if any are set.
BACK TAB	B	Y	Y	Moves cursor backward to last tab position.
CTRL (Control)	C	N	N	Generates nonprinting control codes when used in conjunction with other keys.
				The control key is always used simultaneously with the other characters in the command; i.e., the control key is pressed first and held down while the other keys are pressed. (It is similar in action to the SHIFT key.)
				 The commands which require simultaneous depression of two keys are indicated by a slash separating the two key names.
ESC (Escape)	D	Y	N	The ESC key sends an ASCII code for escape to the computer processor. The key is generally used to momentarily leave (escape) an application program in order to use a special feature or function.
				The escape key is used in conjunction with one alphanumeric character in the command sequence; i.e., the escape key is pressed and <i>released</i> before the second key is pressed.
				 Although escape sequences appear here with a space before the alphanumeric character, this space is <i>not</i> to be entered as part of the sequence. It is included <i>only</i> for the sake of clarity.
RETURN ENTER	E	Y	N	Returns cursor to first character position of line in which the cursor is resting. If Auto Line Feed is on, CR code moves cursor to first character position of the next line.
HOME	F	Y	N	Moves cursor to first character position (Column One) of Line One.



**TABLE 3-1 Continued  
FUNCTION OF KEYS<sup>1</sup>**

Key Name	Area <sup>2</sup>	Transmitted? (Yes/No)	Repeat Action? (Yes/No)	General Function
LINEFEED, ↓	F	Y	Y	Moves cursor down one line.
↑	F	Y	Y	Moves cursor up one line.
BACKSPACE, ←	F	Y	Y	Moves cursor one character to the left.
→	F	Y	Y	Moves cursor one character to the right.
DEL (Delete)	G	Y	Y	The DEL key sends an ASCII DEL character to the computer processor, and (depending on the terminal's communication mode) the computer program echoes the code back to the terminal to be performed. This is usually interpreted by the computer as a character erase code.
BREAK	H	Y	N	Transmits a 250-millisecond ASCII Break pulse to the computer.
CLEAR SPACE	I	Y	Y	Clears the screen to spaces and HOMES the cursor.
PRINT	J	N	N	Toggles printer port on/off.

**NOTES**

1. For Model 910 only. For emulations, see Table A-1.
2. Refer to Figure 3-1 for key location on keyboard.

**3.3.2 Other Controls**

**Cursor**—The lighted rectangular block which appears on the screen indicates the entry spot for the following character to be typed. It is called a “cursor.” During typing, the cursor moves from left to right. As it reaches the end of a line, it “wraps around” to the beginning of the next line, if auto wraparound mode is on. Otherwise, the cursor stays at the end of a line until receiving a CRLF command. If you place the cursor over a character which you have already typed, the character within the cursor will be changed into a reverse image within the cursor. (If the characters have been white on a black background, the cursor will appear as a white rectangle around a black character.)

You can cause the cursor to appear or disappear by entering

ESC .(period)

The movement of the cursor is easy to control. To move the cursor, press one of the cursor control keys marked with an arrow. The cursor will move in the direction of the arrow until you release the key. To return the cursor quickly to the top left position on the screen, press HOME. The cursor will now be in Column One, Line One.



If you are emulating the ADDS 25, pressing HOME will move the cursor to the lower lefthand corner of the screen.

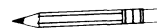

Any desired cursor position in the display area can be programmed using an absolute cursor address of R (line or row) and C (column). (See 4.5 and Table B-1 and C-1.)

**Auto Scroll**—When the terminal is turned on, the Auto Scroll feature will be activated. This feature causes the terminal to automatically scroll as the original display becomes full, making more screen available to you. On the last line, will cause the screen to scroll up.

With Auto Scroll off, the cursor will move downward as long as you press the ↓ or LINEFEED keys. When the cursor reaches the last line, it will wrap back up to Line One (remaining in the same column position). To control the Auto Scroll feature, refer to 4.6.

**Bell**—The terminal can sound a short, loud bell upon your command. To sound the bell, press down CTRL and G at the same time.



From now on, you will not be told to press CTRL and the other character at the same time. The command will be shown as CTRL/G instead.

**Break**—You can transmit a 250-millisecond break pulse (a break signal) to your computer system. The effect will depend on the operating program in your computer system. Usually it stops communication.

### 3.4 BASIC OPERATIONS

This section describes various options available to you as you use the terminal:

- Editing data
- Communicating with your computer system
- Printing

#### 3.4.1 Tab Controls

You can set regular typewriter-style tabs on your terminal. Pressing the TAB key causes the cursor to stop whenever it reaches that column position, regardless of which line the cursor was on when the tab was set. Characters can be superimposed on the tab position. (At power ON, the terminal has tabs every eighth column position.)

**Setting a Tab**—To set a tab, move the cursor to the column position where you need a tab. Enter

ESC 1 (be sure you enter a *numeral* one, not a lower case “L”)

**Using the Tab Setting**—When you want the cursor to go to the tab position, just press the TAB key. The cursor will move to the next tab setting in that line. When it reaches the last tab setting in that line, it will rest. To move the cursor to the previous tab setting, press BACK TAB.

**Clearing Tabs**—You can clear a specific tab by putting the cursor on the tab position you wish to clear and entering

ESC 2

To clear *all* tabs, enter

ESC 3 (cursor position is not important)

#### 3.4.2 Editing

Should you need to change text on the screen, you can erase a line (either partially or completely) or the whole display (either partially or completely). This will give you space to enter the correct data. Erasures will start with the column position under the cursor. The commands for editing are found in Table A-1.

### 3.4.3 Sending Data to the Computer

As you input text at the terminal, it is sent to your computer system. You can either send the information to the computer *at the same time it is displayed on the screen*, or you can send it to the computer and the computer will echo back the information on the screen. (The time needed to echo back the information is so short it will *seem* to happen simultaneously!) Regardless of when you send data, the terminal can always receive information from the computer. When the information is displayed simultaneously with the transmission, it is called “half duplex.” When the information is sent first to the computer and echoed back to the terminal, it is “full duplex.” Refer to Figure 3-1 for a diagram of the information flow.

#### 3.4.4 Sending Data to the Printer

When the printer is printing on a continuous basis, it is an extension of the line from the computer to the terminal—this mode of printing is thus called “extension.” To toggle extension mode on, press the PRINT key. To stop extension mode, simply press PRINT again.

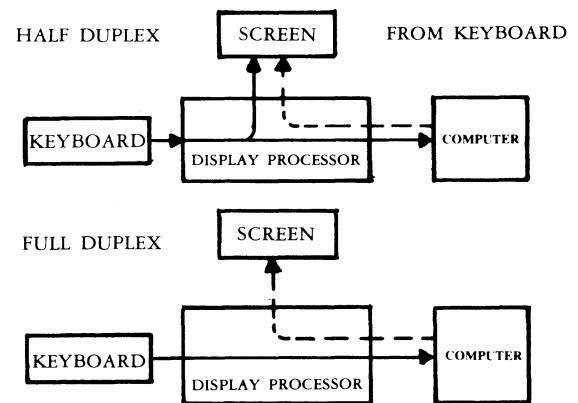

Figure 3-1 Model 910 Communications Flow

## 4. PROGRAMMING

### 4.1 INTRODUCTION

Your computer program can completely control the terminal by transferring the appropriate ASCII codes over the RS232C interface. This chapter tells you how to translate keyboard functions into remote control functions.

The escape sequences and control codes given in the body of this manual are for the 910 terminal. If you have set the terminal to emulate another terminal, refer to Table A-1 or the Quick Reference Chart on the back inside cover for the appropriate codes.

## 4.2 MONITORING CONTROL COMMANDS

You can monitor control commands in several ways:

- Activate the monitor mode command without transmitting them to the computer
- Transmit control codes to the computer and display them
- Display only a single control character

Using monitor mode will make program debugging easier.

To activate display of control commands without transmitting a code to the computer, enter

CTRL/1

To terminate this mode, enter

CTRL/2

To enable monitor mode via the computer, enter

ESC U

This must be echoed by the computer or monitor mode will not be activated.

To terminate the display of the control commands, enter either

ESC u or ESC X

To display a single control character, enter

ESC Fn

where n is the control code to be displayed.

## 4.3 CONTROL FUNCTIONS

When the CONTROL key is used with an alpha or numeric key, bit 7 of the character which is typed is complemented (changed to the opposite), thus changing the code transmitted by that character. Example: If "M" alone is pressed, the code for M is sent. If "CTRL/M" are pressed, the code for a carriage return is sent.

## 4.4 FUNCT KEY

Using the FUNCT (function) key in combination with any one of the numeric keys in the ten-key pad enables you to quickly transmit a three- or four-character sequence of commands. Table 4-1 indicates the code which is transmitted by each of the numeric keys when used with the FUNCT key.

To enter a function command, press the FUNCT key and *at the same time* press a numeric key. The first code which is transmitted will always be

SOH (Control A)

The second will be determined by the numeric key depressed (see Table 4-1). The third code will always be a CR. (Table 2-3).

Program the input/output string routine to catch the entire string and then process it (unless you are using an interrupt-driven computer, in which case you do not need to worry about data being lost).

To eliminate the need for long or hard-to-remember sequences, you can use the FUNCT key to trigger long functions or a chain of commands in the computer.

For ADM emulation, the FUNCT key sends STX plus numeric plus CR.

**TABLE 4-1  
FUNCTION KEY COMMANDS**

Command	ASCII Code Transmitted
FUNCT/0	SOH @ + CR
FUNCT/1	SOH A + CR
FUNCT/2	SOH B + CR
FUNCT/3	SOH C + CR
FUNCT/4	SOH D + CR
FUNCT/5	SOH E + CR
FUNCT/6	SOH F + CR
FUNCT/7	SOH G + CR
FUNCT/8	SOH H + CR
FUNCT/9	SOH I + CR

## 4.5 ADDRESSING THE CURSOR

The computer can tell the terminal where to position the cursor with a four-character escape sequence. (See Table 4-1.) This is called "loading" the cursor.

To load the cursor, enter

ESC = RC

Then enter two more characters to represent the absolute row or line (R) and column (C) where the cursor will rest. Using Table B-1, find the ASCII code representing the desired row. (If you are emulating ADDS, use Table C-1.) Note that the line number can not be greater than 24. Enter the appropriate ASCII code. Next find the ASCII code corresponding to the desired column position (1 through 80 possible) and enter that code. For example, if you want to program the cursor to go to Row 9, Column 50, enter

ESC = (Q



If your computer system inserts nulls between characters, loading the cursor will not function as described—instead the cursor will go to an unpredictable position.

To load only the column, enter

ESC[(column)

and to load only the row, enter

ESC[(row)

The computer can also “read” the cursor’s row and column position. To read the cursor’s position, enter

ESC?

Following the cursor coordinates (row and column), the terminal will transmit a CR.

## 4.6 AUTO SCROLL

You can program the terminal to automatically scroll to a new line as the original display becomes full. The escape sequence which controls this Auto Scroll feature toggles the feature on and off. To start or stop Auto Scroll, enter

ESC H

When the terminal is powered on, Auto Scroll is on.

(Refer also to 3.3.2 for a description of cursor movement when Auto Scroll is not used.)

## 4.7 VISUAL ATTRIBUTES

You can define the appearance of each line on the screen (a whole line or only part of a line). Each line must be defined separately (except half intensity). The choices available are:

**Reverse Video** Changes background of screen on that line to the reverse of that which appears on power ON. If screen is normally black with white characters, this line will now be white with black characters.

**Half Intensity** Changes intensity of the line to half of normal (gray).



Half intensity differs from other visual attributes in that once it is set, it affects all characters entered, regardless of cursor position, until it is turned off.

**Underline** Fills that line with underlines.

**Blink** Causes all characters on the line to blink.

### Blank

All data entered on the line will be invisible to you but will print out and be transmitted to the computer. (A typical application might be payroll information.)

**Setting**—To set a visual attribute, place the cursor one position *before* you want the attribute to start. Attributes occupy a character position. If you want the whole line changed, place the cursor at Column One before entering the attribute command (ESC Gn).

**TABLE 4-2  
ESCAPE SEQUENCES FOR  
VISUAL ATTRIBUTES**

Description	Escape Sequence
Normal video	ESC G0
Blank (invisible normal video)	ESC G1
Blink	ESC G2
Blank (invisible blink)	ESC G3
Reverse video	ESC G4
Blank (invisible reverse video)	ESC G5
Reverse and blink	ESC G6
Blank (invisible reverse blink)	ESC G7
Underline	ESC G8
Blank (invisible underline)	ESC G9
Underline and blink	ESC G:
Blank (invisible blink underline)	ESC G;
Underline and reverse	ESC G <
Blank (invisible underline reverse)	ESC G =
Underline and reverse and blink	ESC G >
Blank (invisible underline reverse blink)	ESC G ?

## 4.8 ENABLING/DISABLING THE PRINTER

To turn on the printer port and also simultaneously display data on the screen, either press PRINT or enter

ESC @

This turns extension and update modes on. Should you only want to activate the printer port and NOT update the display screen, enter

CTRL/R

This turns on transparent and extension modes.

To toggle the printer off (together with the transparent mode), press PRINT again or enter

ESC A

If you had the printer on *without* screen update (transparent) and want to update *and* print, enter

CTRL/T or ESC @

Thus using the PRINT key simply toggles the printer port on and off.

MONITOR MODE CODES  
 CHARACTER SETS  
 HALF INTENSITY  
 BLANK REVERSE  
 REVERSE  
  
 BLINK REVERSE  
  
 NORMAL VIDEO  
 BLANK NORMAL  
 BLINK NORMAL  
 BLANK BLINK  
 REVERSE UNDERLINE  
 BLANK REVERSE UNDERLINE  
 BLINK REVERSE UNDERLINE  
 BLANK BLINK REVERSE  
 NORMAL UNDERLINE  
 BLANK NORMAL UNDERLINE  
 BLINK NORMAL UNDERLINE  
 S1 S2  
 X's DON'T CHANGE

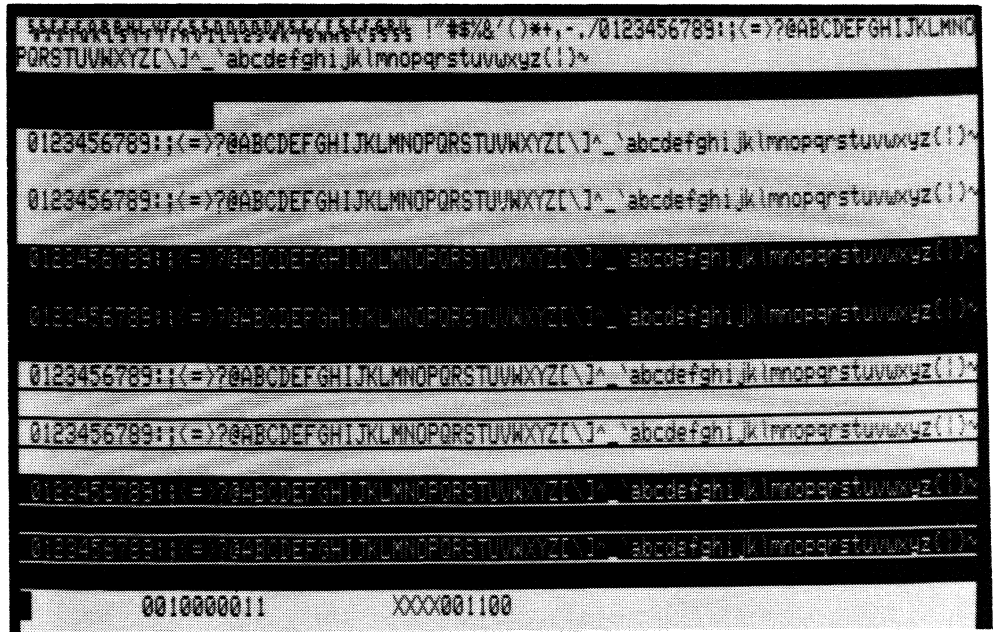

Figure 4-1 Model 910 Video Attributes and Monitor Mode

When the terminal is turned on, the default condition is printer port off and display update on.

#### 4.9 DISABLING THE KEYBOARD

You can disable all keyboard functions by remote commands from the computer. Once the keyboard is disabled, it can *only* be enabled once again by another remote command from the computer.



If your computer system echoes all codes, the keyboard may be accidentally disabled.

To disable the keyboard remotely, enter

ESC #

While the keyboard is disabled, all keys are disabled except FUNCT, PRINT, BREAK, CTRL/1, and CTRL/2.

To subsequently enable it, you must receive an ESC" or type a SHIFT/BREAK (reset) from the keyboard.

#### 4.10 WORD STRUCTURE, PARITY SETTINGS, AND STOP BITS

Each computer system has its own method for checking the transmission of characters from the terminal to verify receipt. In Chapter 2 you were shown how to set the switches in the terminal to match the requirements of your computer system. This section explains the meaning and importance of those settings.

The terminal communicates with the computer in a code called "American Standard Code for Information Interchange," usually abbreviated to ASCII (pronounced ask-key). The code consists of 128 characters in a 7-bit binary format (each bit is either a one or a zero).

The first bit of the transmission is always used as a start bit to tell the computer that a character will be transmitted. (This is *not* part of the character code.) This start bit is always a one. A one may also be referred to as *true* or *mark* or *high*. A zero bit can also be called a *false*, *space*, or *low*.

Following the start bit, the terminal will now send either a 7- or 8-bit character code. These are *data bits*.

To verify correct receipt of the character code, computers may now require that the next bit received serve as a check on the transmission. This is called *parity*. Several methods are used, varying from system to system. The methods used are listed in Table 4-3.

Following any parity bit required, the terminal will also send (as set by the switch settings) either one or two stop bits to signal the end of the character code transmission. Stop bits are always ones.

Figure 4-2 shows the structure of a serial data word.

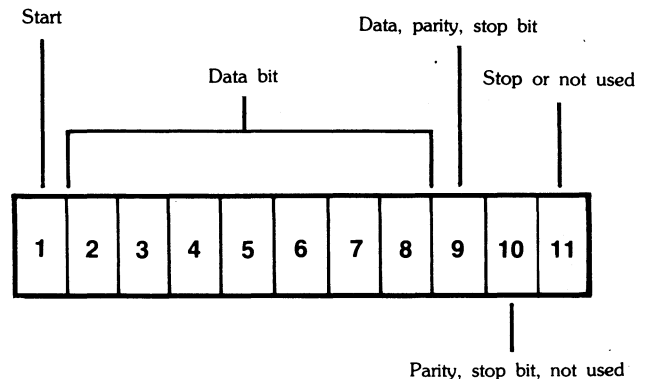

Figure 4-2 Bit Structure of a Serial Data Word

## 4.11 CUSTOM RAM AND ROM APPLICATIONS

You can replace the 2532 ROM (supplied with the 910 terminal) with a 2564 ROM. This replacement will provide an additional 4K ROM, giving you a total of 8K ROM space for special application programs.

## 4.12 CURSOR APPEARANCE/DISAPPEARANCE

You can cause the cursor to appear or disappear by entering

ESC. (period)

## 4.13 BELL

You can cause a short loud bell to sound by entering

CTR/G

**TABLE 4-3  
SWITCH SETTINGS FOR PARITY  
AND DATA BITS**

S1 Switch Position	Setting		Parity	Description
	Up	Down		
7		x	ODD	Requires that the total number of valid data bits be odd or even.
	x		EVEN	Terminal will add a one as necessary to make the total valid data bits sent either odd or even.
8	x <sup>1</sup>		One (or MARK or TRUE)	Requires that a one be sent in the parity position.
5		x <sup>2</sup>	ZERO (or SPACE or FALSE)	Requires that a zero be sent in the parity position.
6	x		SEND	Allows an odd or even parity bit to be sent.
		x	NONE (or NO)	Does not require a parity bit to be sent.
5	x			Causes 7 data bits to be sent.

### NOTES

1. Selecting 2 stop bits on the Model 910 results in ONE parity.
2. Selecting 8 data bits on the Model 910 results in ZERO parity.

# 5. PREVENTIVE MAINTENANCE

## 5.1 CARE

Tender loving care will prolong the useful life of your terminal. Clean and inspect it periodically.

## 5.1.1 Cleaning

To clean the terminal exterior:

1. Vacuum the keyboard every three months with a soft brush attachment (or use a small soft brush).
2. Clean the housing with a soft, lint-free cloth and a commercial detergent every three months.

DO NOT use solvent-based or abrasive cleaners.

## 5.1.2 Inspection

Description	Frequency
1. Inspect the terminal cabinet for cracks or breaks.	1/Yr.
2. Check each key for free movement.	1/Yr.
3. Check the cable connector (at the rear of the terminal cabinet) for damage.	1/Yr.

# 6. TROUBLESHOOTING AND REPAIR

## 6.1 TROUBLESHOOTING

Your computer terminal is just one of several components in the computer system. A failure anywhere else in the system can cause the improper operation of the terminal. The computer system, memory systems, cables, modems, and operational procedures should be checked if there has been a malfunction. Table 6-1 will be helpful in determining the cause of a problem. If this table does not help locate the cause of a problem, run the self test or call a qualified service technician for assistance.

### 6.1.1 Testing the Terminal (Self Test)

You can test the terminal yourself to verify proper operation of the video display circuitry, the transmit and receive portion of the RS232C interface, and the control processor. The test will display all displayable characters, and all 16 video attributes—in both half and full duplex.

To start the test, enter

ESC V

The display screen should now look like that in Figure 4-1. Look at the display carefully to verify that all characters appear, all video attributes appear correctly, and all half intensity characters are shown. Each character should be formed properly and you should not be able to see any extra dots (and no dots should be missing).

Check the switch settings on the terminal against those on the display (see Fig. 4-1). The display will show the dip switches as a 1 (up) or a 0 (down).

To stop the test so you can type, type O (alpha, not zero) or press SHIFT/BREAK.

Should your display not appear as pictured in Figure 4-1 call a qualified service technician.

 S1 switch must be UP or the self test will fail.

## 6.2 REPAIR

Model 910 operator repair is limited to changing the line fuse and the two internal power supply fuses.

### 6.2.1 Changing the Line Fuse

To change the line fuse, proceed as follows:



To avoid electrical shock, disconnect the terminal power cord before changing the line fuse.

1. Disconnect the terminal power cord from primary power.
2. Remove the fuse holder (see Figure 2-2) by unscrewing it counterclockwise.
3. Remove the blown fuse and replace it with a 3AG, 1 amp “slo blo” 125V or 0.5 amp, 250V fuse for 220 VAC applications instantaneous (fast blow) fuse.
4. Install the fuse in the reverse order of Steps 1 through 3.

### 6.2.2 Changing the Power Supply Fuses

The terminal power supply fuses are installed in fuse clips on the power supply assembly inside the terminal. To replace either of these fuses, proceed as follows:



Hazardous voltages are exposed in the cabinet. Turn off the power switch and disconnect power *before* opening the terminal cabinet.

1. Disconnect the terminal power cord from primary power.
  2. Turn the terminal upside down and set it on a soft surface to prevent marring the cabinet. Remove the two Phillips screws that hold the cabinet cover on the terminal.
  3. Turn the terminal right side up and lift off the cabinet cover.  

- Make sure there is adequate table space for the open terminal. It is top heavy and could fall over.
4. Remove the blown fuse from its fuse clip (see Figure 2-4).
  5. Replace the blown fuse with a 3AB, 3 amp, 125V fuse.
  6. Reinstall the terminal cover and secure it with the two screws. (Do not overtighten screws!)

**TABLE 6-1**  
**TROUBLESHOOTING TERMINAL PROBLEMS**

Symptom	Possible Cause	Solution
Terminal dead (no beep; no cursor)	No AC power	Plug in power cord. Turn on power switch. Check 115/230 power switch setting.
Terminal dead; cursor may appear	Loose or defective line or power supply fuses	Turn terminal power off and change fuses.
Terminal will not go on line	System is not “up”	Check status of system.
	Loose, unconnected, or damaged cables	Attach all cables and check for cable damage.
		Check main port (P3) interface cable pins: <ul style="list-style-type: none"><li>• 5, 6, and 8 must be driven by +12 VDC or not connected at all for normal operation.</li><li>• 1 and 7 must be grounded.</li><li>• 3 must be connected to the host transmitter.</li><li>• 2 must be connected to the host receiver.</li></ul>

**TABLE 6-1 Continued  
TROUBLESHOOTING TERMINAL PROBLEMS**

<b>Symptom</b>	<b>Possible Cause</b>	<b>Solution</b>
	Modem not turned on, defective, or phone handset on modem upside down	Turn on modem. Attach different modem. Check phone handset position.
Cursor will not appear	Defective contrast pot Contrast set too light	Refer to technical representative for adjustment of contrast settings.
System does not respond while on line	Incorrect parity switch setting, word structure, stop bits	Set parity switch to match system.
Terminal is not responding to settings	Terminal not powered down after being reconfigured; software has not scanned new settings.	Power down terminal and turn back on.
Terminal "locked up"	System is not responding; communication link broken	Set to half duplex and try to type. If terminal will type, check cables, modem, phone lines, and computer system. Set to full duplex and perform self test.
	Terminal incorrectly set for on line and full duplex	Set to half duplex.
Terminal locked up	Keyboard disabled from computer	Enter ESC #
	Switches set incorrectly	Review Chapter 2 switch settings carefully and check all switch settings.
Terminal prints correct data only part of the time	Parity settings incorrect	Check parity settings with system requirements.
	Stop bits or word structure wrong	Change switch settings.
Display is wavy	Hertz setting incorrect; does not match local power frequency	Change switch setting.
Printer does not print what is typed	Correct print mode selected?	Refer to 3.4 and 4.8.
	Cable connector pins connected incorrectly	Refer to 2.4  Check printer port (P4) interface cable connector pins:  <ul style="list-style-type: none"> <li>• 4 or 20 must be driven by +12 VDC or not connected at all for normal operation</li> <li>• 3 must be connected to printer data input</li> </ul>
		Check other printer port device requirements.



**TABLE 6-1 Continued**  
**TROUBLESHOOTING TERMINAL PROBLEMS**

<b>Symptom</b>	<b>Possible Cause</b>	<b>Solution</b>
Escape and control codes do not function as specified	The escape and/or control codes being used are not correct	Check model number of terminal and code table for correct model of terminal being used.  Make sure upper and lower case codes are used. Is a numeral one required instead of lowercase "L"?
	Keyboard locked in SHIFT position (AUTO LOCK on)	Put in lower case. Connect P3-2 to P3-3 and try in full duplex. Disconnect computer system.
Terminal prints "garbage"	Improper baud rate setting	Set correct baud rate.
	Improper handshaking protocol	Check handshaking protocol requirements of system with terminal protocol.
	Defective modem	Replace modem.
	Noisy telephone lines	Check phone lines. Install dedicated phone lines.
	Static electricity	Check operating environment for static.
	EIA and AC power cords intermingled	Separate cables. Keep EIA cable separate from power cord to prevent noise on data line.
	AC outlet not wired properly	Check for proper wiring and grounding.
Erroneous data sent to computer Scrambled output Terminal loses memory	Static electricity	1. Check operating environment for static problems. 2. Install antistatic floor mat. 3. Spray carpeting with antistatic spray. 4. Increase humidity.
	AC outlet not wired properly	Check for proper wiring and grounding.
Terminal does not print what is typed while on line	Duplex switch incorrectly set	Set duplex switch to match host system.

**TABLE A-1  
SUMMARY OF FUNCTIONAL COMMANDS**

Function	Key	Command <sup>1,2</sup>			ADDS	Description
		910	LS	HZltn		
<b>MOVE CURSOR</b>						
Home	HOME	CRTL/ ^	CTRL/ ^	ESC CTRL/R	CTRL/A	Moves cursor to Column One of Line One.
New line		CTRL/_	*CTRL/_		*CTRL/_	Moves cursor to Column One of next line.
Carriage return	RETURN ENTER	CTRL/M	CTRL/M	CTRL/M	CTRL/M	Returns cursor to Column One of line in which the cursor is resting.
Cursor down	↓ , LINEFEED	CTRL/J	CTRL/J	CTRL J	CTRL/J	Moves cursor down one line.
Cursor up	↑	CTRL/K	CTRL/K	*ESC CTRL/L	CTRL/Z	Moves cursor up one line.
Cursor left	← , BACKSPACE	CTRL/H	CTRL/H	CTRL/H	CTRL/H CTRL/U	Moves cursor one character position to the left.
Cursor right	→	CTRL/L	CTRL/L	CTRL/P	CTRL/F	Moves cursor one character position to the right.
<b>TAB CONTROL</b>						
Set column tab		ESC 1	*ESC 1	*ESC 1	*ESC 1	Sets typewriter-type tab for entire column (from top to bottom of screen) at cursor location.
Clear tab		ESC 2	*ESC 2	*ESC 2	*ESC 2	Clears tab at cursor location.
Clear all tabs		ESC 3	*ESC 3	*ESC 3		Clears all tabs on screen.
Back tab	BACK TAB	ESC I	*ESC I	*ESC I	*ESC I	Moves cursor back to previous tab position. If no previous tabs set, moves cursor to Column One of that line.
Move to tab	TAB	CTRL/I	CTRL/I	*CTRL/I CTRL/N	CTRL/I	Cursor moves to next tab location (if any). If there are no more tabs set, cursor does not move.
<b>EDIT</b>						
Erase line; change to spaces		ESC T	ESC T	*ESC CTRL/O	ESC K	Erases characters from cursor to end of line and replaces them with spaces.
Erase page; change to spaces		ESC Y	ESC Y	*ESC CTRL/X	ESC k	Erases characters from cursor to end of page and replaces them with spaces.
Clear screen; change to spaces	CLEAR	ESC + CTRL/Z	CTRL/Z	ESC CTRL \	CTRL/L	Clears entire screen and changes it to spaces. If half-intensity was on, replaces the page with half-intensity spaces.
Clear screen; change to nulls	SHIFT/CLEAR	ESC *	*ESC *		ESC *	Clears entire screen and changes it to nulls. Cursor position is not important. Sends cursor to HOME position.
Bell		CTRL/G	CTRL/G	*CTRL/G	CTRL/G	

**TABLE A-1 Continued**  
**SUMMARY OF FUNCTIONAL COMMANDS**

Function	Key	Command <sup>1,2</sup>			ADDS	Description
		910	LS	HZltn		
Display control character		ESC Fn	*ESC Fn		ESC Zn	Displays selected control character where "n" is character to be displayed.
<b>TEST</b>						
Self test on		ESC V	*ESC V	ESC CTRL/S	*ESC V	Starts self test
Load cursor (line or row)		ESC[R	*ESC[R		CTRL/KR	Allows host to control cursor position within the row where R is absolute row. See Table B-1 for value of R (Table C-1 for ADDS emulation).
Load cursor (column)		ESC]C	*ESC]C		CTRL/PC	Allows host to control cursor position within column upon transmission of sequence where C is column. See Table B-1 (C-1 for ADDS emulation) for coordinate value.
Load cursor (row, column)		ESC = RC	ESC = RC		ESC YRC	Allows host to position cursor at row and column. See Table B-1 for coordinate values. (Table C-1 for ADDS emulation.)
Load cursor (column, row)				ESC CTRL/ QCR		Allows host to position cursor at row and column. See Table B-1 for coordinate values.
Read cursor (row, column)		ESC ?	*ESC ?		*ESC ?	Transmits row and column coordinates of cursor, followed by the terminator character, to the computer. (See Tables B-1, C-1)
Read cursor (column, row)				ESC CTRL E		Transmits row and column position of cursor plus terminator character to the computer.
Enable keyboard		ESC "	**ESC "	ESC CTRL/F	ESC 6	Enables keyboard to be used. Can only be caused by input from the computer.
Disable keyboard		ESC #	**ESC #	ESC CTRL/U	ESC 5	Disables keyboard.
Enable printer port		ESC @	CTRL/N	*ESC/	CTRL/R	Enables printer to start printing; screen will display updated data.
Disable printer port		ESC A	CTRL/O	*ESC ?	CTRL/T	Disables printer port; leaves display update on.
Enable transparent print		CTRL/R	*ESC @	*ESC *	ESC 3	Enables transparent print mode; screen will not display updated data.
Disable transparent print		CTRL/T	*ESC A	*ESC /	ESC 4	Disables transparent print mode; screen will display updated data.
Auto scroll on/off		ESC H	*ESC H		*ESC H	Toggles Auto Scroll on/off. Auto Scroll permits another line when screen is full.

## TABLE A-1 Continued SUMMARY OF FUNCTIONAL COMMANDS

Function	Key	Command <sup>1,2</sup>			Description
		910	LS	HZltn	
<b>VISUAL ATTRIBUTES</b>					
Normal video (same as set during installation)		ESC G0		*ESC CTRL/G0	ESC G0
Invisible normal (blank)		ESC G 1		*ESC CTRL/G1	ESC G1
Blink		ESC G 2		*ESC CTRL/G2	ESC G2
Invisible blink (blank)		ESC G 3		*ESC CTRL/G3	*ESC G3
Reverse (opposite of that set during installation)		ESC G 4		*ESC CTRL/G4	*ESC G4
Invisible reverse (blank)		ESC G 5		*ESC CTRL/G5	*ESC G5
Reverse blink		ESC G 6		*ESC CTRL/G6	*ESC G6
Invisible blink reverse (blank)		ESC G 7		*ESC CTRL/G7	*ESC G7
Underline		ESC G 8		*ESC CTRL/G8	*ESC G8
Invisible underline (blank)		ESC G 9		*ESC CTRL/G9	*ESC G9
Blink underline		ESC G :		*ESC CTRL/G:	*ESC G:
Invisible blink underline (blank)		ESC G ;		*ESC CTRL/G;	*ESC G;
Reverse underline		ESC G <		*ESC CTRL/G <	*ESC G <
Invisible reverse underline (blank)		ESC G =		*ESC CTRL/G =	*ESC G =
Reverse blink underline		ESC G >		*ESC CTRL/G >	*ESC G >
Invisible reverse blink underline (blank)		ESC G ?		*ESC CTRL/G ?	*ESC G ?
Half intensity on		ESC )	ESC )	*ESC CTRL/Y	*ESC G )
Half intensity off		ESC (	ESC (	*ESC CTRL/_	*ESC G (
Display normal/reverse			ESC G		
Cursor visible/invisible		ESC . (period)	*ESC.		*ESC.

## TABLE A-1 Continued SUMMARY OF FUNCTIONAL COMMANDS

Function	Key	Command <sup>1,2</sup>				Description
		910	LS	Hzltn	ADDS	
<b>MONITOR</b>						
Monitor off (local)		CTRL/2	*CTRL/2	*CTRL/2	*CTRL/2	Stops monitor mode.
Monitor on		ESC U	*ESC U			Transmits control codes to computer and displays them.
Monitor off		ESC u ESC X	*ESC u ESC X			Stops monitor mode.
Monitor on (local)		CTRL/1	*CTRL/1	*CTRL/1	*CTRL/1	Displays control codes without transmitting them.

### Legend

910 = TeleVideo 910; LS = Lear Siegler ADM-5/3A; Hzltn = Hazeltine 1410; ADDS = ADDS 25

### NOTE

1. Slash means depress CTRL key at same time control character is pressed. ESC CTRL/ means press and release ESC key before pressing CTRL and other character. Do not add spaces. User upper and lower case characters as indicated.

2. For transmitted code sequences for each function, refer to the Command column.

\* Additional emulation codes.

\*\* Differs from original code.

## TABLE B-1 CURSOR COORDINATES

### CURSOR POSITIONING

POSITION R or C*	ASCII CODE Transmitted	POSITION C	ASCII CODE Transmitted	POSITION C	ASCII CODE Transmitted
1	Space	33	@	65	
2	!	34	A	66	a
3	"	35	B	67	b
4	#	36	C	68	c
5	\$	37	D	69	d
6	%	38	E	70	e
7	&	39	F	71	f
8	'	40	G	72	g
9	(	41	H	73	h
10	)	42	I	74	i
11	*	43	J	75	j
12	+	44	K	76	k
13	,	45	L	77	l
14	-	46	M	78	m
15	.	47	N	79	n
16	/	48	O	80	o
17	0	49	P	81	p
18	1	50	Q	82	q
19	2	51	R	83	r
20	3	52	S	84	s
21	4	53	T	85	t
22	5	54	U	86	u
23	6	55	V	87	v
24	7	56	W	88	w
25	8	57	X	89	x
26	9	58	Y	90	y
27	:	59	Z	91	z
28	;	60	[	92	{
29	<	61	\	93	
30	=	62	]	94	}
31	>	63	^	95	~
32	?	64	-	96	DEL/RUB

\* Value of R can't be greater than 24.

**TABLE C-1  
ADDS CURSOR COORDINATES**

Row Position	ASCII Code Transmitted	Column Position	ASCII Code Transmitted	Column Position	ASCII Code Transmitted
1	@	1	CTRL/@	41	@
2	A	2	CTRL/A	42	A
3	B	3	CTRL/B	43	B
4	C	4	CTRL/C	44	C
5	D	5	CTRL/D	45	D
6	E	6	CTRL/E	46	E
7	F	7	CTRL/F	47	F
8	G	8	CTRL/G	48	G
9	H	9	CTRL/H	49	H
10	I	10	CTRL/I	50	I
11	J	11	CTRL/P	51	P
12	K	12	CTRL/Q	52	Q
13	L	13	CTRL/R	53	R
14	M	14	CTRL/S	54	S
15	N	15	CTRL/T	55	T
16	O	16	CTRL/U	56	U
17	P	17	CTRL/V	57	V
18	Q	18	CTRL/W	58	W
19	R	19	CTRL/X	59	X
20	S	20	CTRL/Y	60	Y
21	T	21	SP	61	/
22	U	22	!	62	a
23	V	23	"	63	b
24	W	24	#	64	c
		25	\$	65	d
		26	%	66	e
		27	&	67	f
		28	'	68	g
		29	(	69	h
		30	)	70	i
		31	0	71	p
		32	1	72	q
		33	2	73	r
		34	3	74	s
		35	4	75	t
		36	5	76	u
		37	6	77	v
		38	7	78	w
		39	8	79	x
		40	9	80	y

**TABLE D-1 ASCII Chart**

Bits		Column		000	001	010	011	100	101	110	111				
b7	b6	b5	b4	b3	b2	b1	Row	0	1	2	3	4	5	6	7
0	0	0	0	0	0	0	0	NUL	DLE	SP	0	@	P	·	p
0	0	0	1	1	0	0	1	SOH	DC1	!	1	A	Q	a	q
0	0	1	0	1	0	0	2	STX	DC2	"	2	B	R	b	r
0	0	1	1	1	0	0	3	ETX	DC3	#	3	C	S	c	s
0	1	0	0	0	1	0	4	EOT	DC4	\$	4	D	T	d	t
0	1	0	1	0	1	0	5	ENQ	NAK	%	5	E	U	e	u
0	1	1	0	0	1	0	6	ACK	SYN	&	6	F	V	f	v
0	1	1	1	0	1	0	7	BEL	ETB	'	7	G	W	g	w
1	0	0	0	0	1	0	8	BS←	CAN	(	8	H	X	h	x
1	0	0	1	0	1	0	9	SKIP HT	EM	)	9	I	Y	i	y
1	0	1	0	0	1	0	10	LF	SUB	*	:	J	Z	j	z
1	0	1	1	0	1	0	11	VT↑	ESC	+	;	K	[	k	{
1	1	0	0	0	1	0	12	FF→	FS	,	<	L	\	l	
1	1	0	1	0	1	0	13	CR	GS	-	=	M	]	m	}
1	1	1	0	0	1	0	14	SO	HOME RS	.	>	N	^	n	~
1	1	1	1	0	1	0	15	SI	NEW LINE US	/	?	O	_	o	DEL RUB

# INDEX

- Addressing Cursor, 4.5
- ASCII codes, 4.10, TC-1
- Attributes, visual, 4.7, TA-1
- Auto Scroll, 3.3.2, 4.6, TA-1
  
- Baud rate settings, 2.4, T2-3, T6-1, 3.2.1
- Bell, 3.3.2, TA-1
- Blank, 4.7, TA-1
- Blink, 4.7, TA-1
- Break, 3.3.2, TA-1
  
- Character sets, vi, 2.4.4, T2-6
- Clear, T3-1, TA-1
- Computer connection, T4.2, T2-2
- Contrast, screen, 3.2.2, T6-1
- Control commands, 4.2, 4.3, TA-1
- Control key functions, T3-1, TA-1
- Cursor, addressing, 4.5
  - appearance, T2-3, 3.3.2
  - controls, 3.32, TA-1
  - loading, 4.5, TB-1
  - reading, TB-1
- Customizing RAM/ROM, 4.11
  
- Data bits, T2-3, T2-4, T4-3, 4.10
- Data Carrier Detect, T2-3, T2-1
- Data Set Ready, T2-3, T2-1
- Data Terminal Ready, T2-3, T2-1
- Dimensions, vi, F2-1
- Display, (see also screen)
  - update, 4.8
- Duplex, full, T2-3, 3.4.3, T6-1
  - half, T2-3, 3.4.3, T6-1
  - setting, T2-3
  
- Edit commands, 3.4.2, TA-1
- Emulations, 2.4.4, T2-6
- Escape functions
  - key, T3-1
  - sequences, TA-1
- Extension mode, 3.4.4, TA-1
  
- FUNCTION key, T3-1, 4.4, T4-1
- Fuses, changing, 6.2
  
- Half intensity, 4.7, T4-2
- Hertz settings, 2.4.4, T2-3
  
- Inspection, 2.2, 5.1
- Installation, 2.4
  - checklist, 2.5
- Interface connections, 2.4.2, T2-1
  
- Jumper options, T2-5, T2-6
  
- Key functions, T3-1, TA-1
  - repeat action, T3-1
- Keyboard controls, 3.3, TA-1
  - enable/disable, 4.9, TA-1
  - layout, 3.3.1, F3-1, TB-1
  
- Line frequency (see Hertz)
- Logic board, F2-3
  
- Maintenance, CH 5
  - contract, iv
  - Manual, how to use, 1.2
  - Monitor mode, 4.2, TA-1
  
- Operation, CH.3, 3.2
- Operator's Quick Reference Guide, back cover
  
- Parity settings, 2.4.4, T2-3, T2-4, 4.10, T4-3, F4-2, T6-1
- Physical requirements, vi, 2.3.2, F2-1
- Pin connections, 2.4.2, T2-1, 2.4.3, T2-2
- Power configuration, vi, 2.4.1, T2-3
  - requirements, 2.3.1
  - select switch, 2.4.1, F2-2
- Printer enable/disable, 4.8, TA-1
  - interface, 2.4.3, T2-2
- Programming, CH. 4
  - debugging, 4.2
  - notes, 1.2
  
- Quick Reference Guide, back cover
  
- RAM changes, 4.11
- Rear panel, F2-2, 3.2.1
- Repair, 6.2
- Reporting damage, 2.2.4
- Reset, 2.4.4, 4.9
- Returned Material Authorization, iii
- Reverse video, 4.7, T4-2, TA-1
- ROM changes, 4.11
- RS232, T2-5
  
- Safety precautions, 1.4
- Screen update, 4.8, TA-1
- Self-test, 6.1
- Sending data to computer, 3.4.3, TA-1
  - data to printer, 3.4.4, 4.8, TA-1
- Serial number, iv
- Service, iii
- Shipping, iii, 2.2.5
- Signals, 2.4.4, T2-1
- Site preparation, 2.3
- Specifications, vi
- Start bit, 4.10
- STOP notes, 1.2
- Stop bits, 2.4.4, T2-3, T2-4, 4.10, F4-2, T4-3

Strapping (see Jumper Options)  
Switch settings, 2.4.4, T2-3, T2-4  
  record of, v  
Symbols, 1.2

Tab controls, T3-1, 3.4.1, TA-1  
Technical assistance, iv  
Terminal, adjusting, 3.2.2  
  cleaning, 5.4  
  configuration, Ch 2  
  description, 1.3  
  interior, F2-4  
  protection, 1.5, CH. 5  
  turning on, 2.5, 3.2  
Terminating character, 2.4.4, T2-3, 4.4, T4-1  
Test, self, 6.1.1  
Transmitting to computer, 3.4.3  
  to printer, 3.4.4  
Troubleshooting, CH. 6, T6-1  
Turn-on procedure, 3.2

Underlining, 4.7, T4-2, TA-1  
Unpacking, 2.2.2  
Updating screen (see Display)

Video display, 2.4.4, T2-3, 4.7, 4.2  
Visual attributes, 4.7, T4-2, F4-2,

Warranty, extended, iv  
  policy, iii  
  service under, iii  
  service not under, iii  
Word structure, 2.4.4, T2-3, T2-4, 4.10, F4-2

## GLOSSARY

### ASCII

The acronym for American Standard Code for Information Interchange. This is a standardized code for the transmission of data within the United States. It is composed of 128 characters (upper and lowercase letters, numerals, punctuation marks, symbols, and control characters) in a 7-bit binary format.

### Asynchronous Communication

A method of communication where the time synchronization of the transmission of data between the sending and receiving stations is set by start and stop bits and the baud rate.

### Baud

The rate of transmission of data. One baud equals one binary bit per second.

### Bit

An abbreviation for *binary digit*. A bit is the smallest unit of data. ASCII codes are composed of seven bits.

### BREAK

To break or interrupt communications. When the BREAK switch on the terminal is toggled, a 250-millisecond tone is sent to the computer to immediately halt communications.

### Buffer

An electronic device within the terminal that allows for the temporary storage of incoming data should the transmission rate of the incoming data be faster than the terminal's printing speed.

### Bug

An error in a computer program or in the operation of the computer.

### Byte

A coded group of binary bits which represents a character (letter, numeral, symbol, command, etc.).

### Code

A method of representing data by groups of binary digits.

### Command

A code that will cause the terminal or computer to perform an electronic or mechanical action.

### Computer

An electronic system which, in accordance with its programming, will store and process information and perform high-speed mathematical or logical operations.

### Control Codes

Special nonprinting codes which cause the terminal or computer to perform specific electronic or mechanical actions (such as setting tabs, etc.).

### CPU

Central Processing Unit. The "brains" of a computer or computer terminal; that section where the logic and control functions are performed.

### Default

Condition which exists from POWER ON or RESET if no instructions to the contrary are given to the terminal.

### DEL

The ASCII DELETE code used in some instances to delete transmitted characters or to exit modes of operation.



## **Digit**

One of the numerals in a number system.

## **Digital**

Information in the form of individual parts—bits or digits.

## **EOT**

An ASCII code that means “end of transmission” (EOT); used in the EOT/ACK handshaking protocol. The computer sends an EOT at the end of each transmission to the terminal. When the terminal is ready to receive more data, it transmits an acknowledge (ACK) back to the computer.

## **ESC**

An ASCII code meaning “escape” which is used to control various electronic and mechanical functions of the terminal.

## **Full Duplex**

In full duplex communication, the terminal can transmit and receive *simultaneously*. The transmitted data is not printed locally unless it is “echoed back” by the computer.

## **Half Duplex**

In half duplex communication, the terminal transmits and receives data in separate, *consecutive operations*. Transmitted data is printed locally.

## **Handshaking**

A communications protocol which is necessarily used when the transmitting speed of the computer is faster than the printing speed of the terminal. It consists of a set of commands, recognized by both stations, which control the flow of the data transmission from the computer.

## **Hardware**

The electronic components of a computer system or terminal.

## **Host**

The computer system.

## **Interface**

A communications channel which is typically used for external devices.

## **Main**

The computer system.

## **Memory**

That part of a computer system or terminal where information is stored.

## **Microprocessor**

An electronic circuit on the surface of a small silicon chip which can be programmed to perform a wide variety of functions within the computer system or terminal.

## **Modem**

An electronic device which converts (modulates) the serial communications between the computer and terminal into audible tones which can be transmitted over telephone lines. All received data is reconverted (demodulated) from the audible tones into serial information.

## **NUL**

An ASCII code (“nothing”) which is used as a fill character in some communications formats.

## **Parity**

A method of checking for errors in data communications. An extra bit (either a “1” or “0”), called the parity bit, is added to the end of each ASCII character to make the final count of “1” bits in the character an even or odd number, according to a prearranged format. Some systems always use even parity, some always use odd parity, and some do not check for parity. Both terminal and system *must* be set for the same parity.

## **Protocol**

All of the conventions which must be observed in order for the computer and terminal to communicate with each other.

## **Serial Communication**

The standard method of ASCII character transmission where bits are sent, one at a time, in sequence. Each 7-bit ASCII character is preceded by a start bit (see Asynchronous Communication) and ended with a parity bit and stop bit.

## **Toggle**

Activation or deactivation of function or mode key (either a receive key, command sequence, or manual keystroke).

## **X-ON/X-OFF**

A handshaking protocol. When the terminal’s buffer is nearly full, it transmits an X-OFF to the computer to stop transmission; when the buffer is almost empty, an X-ON is transmitted to the host to resume transmission.

## **Wraparound**

Movement of the cursor as it reaches the right edge of screen, disappears, and “wraps around” to the beginning of the next line.

## OPERATOR'S QUICK REFERENCE GUIDE

Function	910	Lear Siegler	Hazeltine	ADDS
<b>CURSOR</b>				
HOME	CTRL/ ^	CTRL/ ^	ESC CTRL/R	CTRL/A
New line	CTRL/ _	CTRL/ _		CTRL/ _
Carriage return	CTRL/M	CTRL/M	CTRL/M	CTRL/M
Linefeed/cursor down	CTRL/J	CTRL/J	CTRL/J	CTRL/J
Cursor up	CTRL/K	CTRL/K	ESC CTRL/L	CTRL/Z
Backspace/cursor left	CTRL/H	CTRL/H	CTRL/H	CTRL/H
Cursor right	CTRL/L	CTRL/L	CTRL/P	CTRL/U CTRL/F
<b>TAB</b>				
Set column tab	ESC 1	ESC 1	ESC 1	ESC 1
Clear tab	ESC 2	ESC 2	ESC 2	ESC 2
Clear all tabs	ESC 3	ESC 3	ESC 3	
Back tab	ESC I	ESC I	ESC I	ESC I
Tab	CTRL/I	CTRL/I	CTRL/I CTRL/N	CTRL/I
<b>EDIT</b>				
Erase line to spaces	ESC T	ESC T	ESC CTRL/O	ESC K
Erase page to spaces	ESC Y	ESC Y	ESC CTRL/X	ESC k
Clear screen to nulls	ESC *	ESC *		ESC *
Clear screen to spaces	ESC + CTRL/Z	CTRL/Z	ESC CTRL \	CTRL/L
<b>PROGRAM</b>				
Load cursor (row)	ESC[R	ESC[R		CTRL/K R
Load cursor (column)	ESC]C	ESC]C		CTRL/P C
Load cursor (row, column)	ESC = RC	ESC = RC		ESC Y R C
Load cursor (column, row)			ESC CTRL/Q C R	
Read cursor (row, column)	ESC ?	ESC ?		ESC ?
Read cursor (column, row)			ESC CTRL/E	
Enable keyboard	ESC "	ESC "	ESC CTRL/F	ESC 6
Disable keyboard	ESC #	ESC #	ESC CTRL/U	ESC 5
Enable printer port	ESC @	CTRL/N	ESC /	CTRL/R
Disable printer port	ESC A	CTRL O	ESC ?	CTRL/T
Enable transparent print	CTRL/R	ESC @	ESC *	ESC 3
Disable transparent print	CTRL/T	ESC A	ESC /	ESC 4
Bell	CTRL/G	CTRL/G	CTRL/G	CTRL/G
<b>VIDEO</b>				
Normal video	ESC G0		ESC CTRL/G0	ESC G0
Normal/reverse video		ESC G		
Blank normal	ESC G1		ESC CTRL/G1	ESC G1
Blink	ESC G2		ESC CTRL/G2	ESC G2
Blank (invisible blink)	ESC G3		ESC CTRL/G3	ESC G3
Reverse video	ESC G4		ESC CTRL/G4	ESC G4
Blank (invisible reverse)	ESC G5		ESC CTRL/G5	ESC G5
Reverse blink	ESC G6		ESC CTRL/G6	ESC G6

## OPERATOR'S QUICK REFERENCE GUIDE Continued

Function	910	Lear Siegler	Hazeltine	ADDS
Blank (invisible reverse blink)	ESC G7		ESC CTRL/G7	ESC G7
Underline	ESC G8		ESC CTRL/G8	ESC G8
Blank (invisible underline)	ESC G9		ESC CTRL/G9	ESC G9
Underline blink	ESC G:		ESC CTRL/G:	ESC G:
Blank (invisible underline blink)	ESC G;		ESC CTRL/G;	ESC G;
Reverse underline	ESC G<		ESC CTRL/G<	ESC G<
Blank (invisible reverse underline)	ESC G=		ESC CTRL/G=	ESC G=
Reverse blink underline	ESC G>		ESC CTRL/G>	ESC G>
Blank (invisible reverse blink underline)	ESC G?		ESC CTRL/G?	ESC G?
Half intensity on	ESC )	ESC )	ESC CTRL/Y	ESC On )
Half intensity off	ESC (	ESC (	ESC CTRL/_	ESC ON (
Cursor visible/invisible	ESC . (period)	ESC . (period)		ESC . (period)

### MONITOR

Monitor mode on (not transmitted)	CTRL/1	CTRL/1	CTRL/1	CTRL/1
Monitor mode off (not transmitted)	CTRL/2	CTRL/2	CTRL/2	CTRL/2
Monitor mode on (transmitted)	ESC U	ESC U		
Monitor mode off (transmitted)	ESC u ESC X	ESC u ESC X		
Display single control character (n = control character)	ESC Fn	ESC Fn		ESC Zn
Auto scroll on/off	ESC H	ESC H		ESC H

### SELF TEST

Self test on	ESC V	ESC V	ESC CTRL/S	ESC V
--------------	-------	-------	------------	-------

S1	1	2	3	4	5	6	7	8	9	10	
1 2 3 4	9600	BAUD RATE BIT 3	BAUD RATE BIT 2	BAUD RATE BIT 1	BAUD RATE BIT 0	WORD LENGTH	NO PARITY	EVEN/ ODD PARITY	STOP BITS	TERM CHAR	TERM CHAR
DN DN DN UP	50	SEE CHART				7 BITS	SEND PARITY	EVEN	TWO BITS	SEE CHART BELOW	
DN DN UP DN	75					8 BITS	NO PARITY	ODD	ONE BIT		
DN DN UP UP	110										
DN UP DN DN	135										
DN UP DN UP	150										
DN UP UP DN	300	EMULA-TION	EMULA-TION	50/60 HERTZ	CURSOR MODE	CURSOR MODE	FULL/ HALF DUPLEX	WOB BOW	DSR	DCD	ENABLE DTR
DN UP UP UP	600	SEE CHART BELOW		60 Hz	SEE CHART BELOW		FULL	WOB	DIS-CON	DIS-CON	DIS-CON
UP DN DN DN	1200						HALF	BOW	CON	CON	ON W/ TERM
UP DN DN UP	1800										
UP DN UP DN	2400										
UP DN UP UP	3600										
UP UP DN DN	4800	S2 1 2	S2 4 5		S1 9 10						
UP UP DN UP	7200	DN DN	STD 910	DN DN	BLOCK BLINK						
UP UP UP DN	9600	DN UP	ADM 5	DN UP	UNDERLINE BLOCK						
UP UP UP UP	19200	UP DN	ADDS	UP DN	BLOCK STEADY						
		UP UP	HAZELTINE	UP UP	UNDERLINE STEADY						

(See Page 4)



 **TeleVideo<sup>®</sup> Systems, Inc.**

Printed in U.S.A.

TeleVideo Systems, Inc., 1170 Morse Avenue, Sunnyvale, California 94086  
408/745-7760 800/538-8725 (tollfree outside CA) TWX 910 338 7633