

**TeleVideo®
Video Display Terminal
Operator's Manual**

924

TeleVideo[®] 924 Video Display Terminal Operator's Manual

TeleVideo Document 3090301
2 April 1984

Copyright

Copyright (c) 1984 by TeleVideo Systems, Inc. All rights reserved. No part of this publication may be reproduced, transmitted, transcribed, stored in a retrieval system, or translated into any language or computer language, in any form or by any means, electronic, mechanical, magnetic, optical, chemical, manual, or otherwise, without the prior written permission of TeleVideo Systems, Inc., 1170 Morse Avenue, Sunnyvale, California 94086.

Disclaimer

TeleVideo Systems, Inc. makes no representations or warranties with respect to this manual. Further, TeleVideo Systems, Inc. reserves the right to make changes in the specifications of the product described within this manual at any time without notice and without obligation of TeleVideo Systems, Inc. to notify any person of such revision or changes.

FCC

“Warning: This equipment generates, uses, and can radiate radio frequency energy, and if not installed and used in accordance with the instruction manual may cause interference to radio communications. It has been tested and found to comply with the limits for a Class A computing device pursuant to Subpart J of Part 15 of FCC Rules, which are designed to provide reasonable protection against such interference when operated in a commercial environment. Operation of this equipment in a residential area is likely to cause interference, in which case the user at his own expense will be required to correct the interference.”

TeleVideo[®] is a registered trademark of TeleVideo Systems, Inc.

Introduction

Understanding how to use the features of this new terminal will ensure you receive the maximum benefit from them. The manual explains the terminal's features and tells you how to install, operate, program, and troubleshoot the terminal.

Take a moment to become familiar with the manual first. The first few chapters contain general information, while the last few increase in complexity. Each chapter is summarized below.

GLOSSARY

Definition of technical terms from this manual

1. INSTALLATION

How to install the terminal and turn it on; how to add optional features

2. RECONFIGURING THE TERMINAL

How to set up the terminal to work with your computer and printer and change many operating values in the set up lines or the status line

3. OPERATOR CONTROLS

Purpose of each special key and the ASCII code it sends; how to edit, transmit, and print from the terminal

4. PROGRAMMING CONTROLS

How you can control the terminal from application programs or from the keyboard

5. REPROGRAMMING THE TERMINAL

How to reprogram many of the keys and terminal functions

6. TROUBLESHOOTING

Solutions for many common problems; how to change fuses, run self tests, and obtain assistance

APPENDICES

Specifications, limited warranty, reference tables

INDEX

QUICK REFERENCE GUIDE

Control codes and escape sequences

The manual is written for two types of users: **relatively new terminal operators** and **experienced programmers**. If you are relatively inexperienced, skip the programming chapters (Chapters 4 and 5) until you are ready to try more advanced operations.

Look at the chart below to select the chapters corresponding to your current level of experience.

Reader	Glossary	Chapters					
		1	2	3	4	5	6
Installer		x	x				x
New user	x		x	x			x
Experienced user			x	x	x		x
Programmer			x	x	x		
Experienced programmer			x	x	x	x	

Conventions

Notes

Two types of notes mark information of special importance:

NOTE! *Information for everyone.*

STOP! *Warning concerning your safety or possible loss of data. When you see this note, STOP and read the note before proceeding!*

Terminology

The optional lines of memory allow you to create pages longer than the 24-line screen display. The manual differentiates between the terms **screen** and **page**.

Screen The terminal's viewing area.

Page An amount of memory, defined by the memory chips installed. May contain 24, 48, or 96 lines. Since the screen displays 24 lines at a time, a longer page is not visible all at once.

Figures

The amount of data contained within a page of memory or displayed on the screen is not shown to scale in the figures. Shaded areas denote protected fields, unless otherwise noted. Areas with slanted lines show how much data is sent by a command. Dots indicate space characters.

Status and Set Up Line Parameters

You can change some of the modes and functions described in the chapter on programming from the keyboard in the status and set up lines. These parameters are indicated in Chapter 4 by the words **SET UP** and **STATUS** next to the section heading.

Entering Commands

Enter each command exactly as shown or it won't work as expected. (Spaces shown in the commands, however, are included only to make the command easier to read.)

Notice whether the command requires uppercase or lowercase characters, the number **one** or a lowercase **L**, a **zero** or an uppercase **O**. Make sure the ALPHA LOCK key is not depressed when you want a lowercase character.

Using the ESC Key

Although escape sequences are printed with a space before the alphanumeric character(s), that space is only included so the sequence is easier to read; it is not actually part of the sequence. For example, if the sequence is shown as

ESC U

you should

Press and release the ESC key

Hold down the SHIFT key while you press and release the u key

NOTE! *To enter an escape sequence, always press and release the ESC key before pressing the next key(s). Don't press the space bar after pressing the ESC key. The spaces shown in the commands are included only to make the command easier to read.*

Using the CTRL Key

Pressing the CONTROL (CTRL) key by itself has no effect—you must hold it down while you press the other character in the control sequence.



Table of Contents

Introduction	iii	Locking/Unlocking the Keyboard	44
Glossary	xi	Cursor Style	44
1. Installation	1	Keyclick and Bell	44
Introduction	1	Display Controls	45
Inspecting the Terminal	1	Contents of the 25th Line	45
Selecting a Good Location	2	Controlling the 25th Line's Display	45
Space Requirements	3	The Status Line	45
Installing the Terminal	3	The Message Line	45
Connecting the Keyboard	3	Screen Display	46
Setting the Power Select Switch	4	Screen Attributes	46
Connecting the Terminal to a		Visual Attributes	47
Computer System	5	Block Attributes	48
Connecting the Terminal to a Printer	6	Block Graphics	49
Plugging In and Turning On the Terminal	7	Special Graphics Mode	50
Field Modifications	8	Character Set	50
General Instructions	8	Additional Screen Memory	50
Current Loop	10	Configuring Memory	50
Adding More Screen Memory	12	Autopage Mode	52
Adding a Monitor	12	Moving to a Different Page	52
Adding a European Base Plate	13	Scrolling	53
Installation Summary	14	Defining a Scrolling Region	54
2. Reconfiguring the Terminal	15	Creating Protected Forms	55
Why Reconfiguration Is Necessary	15	Why Protect Mode and Logical	
How To Reconfigure the Terminal	15	Attributes Are Available	55
Changing the Set Up Lines	15	Assigning Logical Attributes	55
Changing the Status Line	25	Logical Attribute Mode	56
Reconfiguration Summary	27	Controlling Protected Writing and	
Summary of Set Up Mode Procedures	28	Protect Modes	57
3. Operator Controls	29	Steps Involved in Protect Mode	57
Introduction	29	Procedure for Entering Data To Be	
The Keyboard	29	Protected	57
Character Keys	29	Effects of Protect Mode	58
Special Keys	29	Cursor Control	58
The Cursor	36	Line Feed and Reverse Line Feed	58
Editing	36	Directional Cursor Movement	62
Communication Modes	36	Addressing and Reading the Cursor	67
Sending Data to the Computer	37	Addressing the Cursor	67
Printing	38	Reading the Cursor	68
4. Programming Controls	39	Hidden Cursor	69
Introduction	39	Function Keys	69
Using These Commands in Your		Default Values	69
Programs	39	The FUNCT Key	70
Entering These Commands on the		TAB STOPS	70
Keyboard for Local Display	39	Set Tab Stops	71
Figures	39	Moving the Cursor to a Tab Stop	72
Conventions	39	Clearing a Typewriter Tab Stop(s)	77
Monitor Mode	39	Clearing a Field Tab Stop	77
Resetting the Terminal	40	Communication Modes	77
Set Up Memory	40	Edit Modes	77
Send Message/Status Line	44	Changing Data	78
Send Terminal Configurations	44	Edit Boundary Modes	78
		Editing Commands	79
		Clearing Data from Memory	85
		Selecting a Handshaking Protocol	87
		X-On/X-Off	87
		Data Terminal Ready	88

Table of Contents Continued

Data Transmission	88	Index	X-1
Sending Data	88	Quick Reference Guide	Q-1
Defining How Much Will Be Sent	96		
Miscellaneous Send Commands	96		
Printing	97		
Printer Handshaking Protocols	101		
5. Reprogramming the Terminal	103		
Introduction	103		
Port Control	103		
Delimiters	104		
Answerback Message	104		
Keys	105		
One Editing Key	105		
All Editing Keys	106		
How Much Can Be Programmed into Each Key	106		
Entering a Sample Program	106		
Function Key(s)	107		
How Long Can the Message Be?	107		
What Can the Message Include?	107		
Determining Where the Program Goes	108		
Entering a Sample Program	108		
Message Line	110		
6. Troubleshooting	111		
Introduction	111		
Self Tests	111		
Self Testing the Video Display Circuitry	111		
Self Testing Port Communications	112		
Troubleshooting Procedures	112		
Inspection	114		
Checking the Fuses	116		
Power Supply Fuses	116		
Line Fuse	117		
If You Need Assistance	117		
Technical Assistance	118		
Customer Service	118		
Service Under Warranty	118		
Reshipping the Terminal	118		
Appendices	A-1		
Appendix A Specifications	A-3		
Appendix B Statement of Limited Warranty	A-5		
Appendix C ASCII Code Tables	A-6		
Appendix D Monitor Mode Control Characters	A-11		
Appendix E Cursor Coordinates	A-13		
Appendix F Control Codes	A-14		
Appendix G Escape Sequences	A-15		
Appendix H Character Sets	A-19		
Appendix I Set Up Memory Bit Map	A-24		

List of Tables

1-1	RS-232C Computer (DCE) Interface Connector Assignments	5	4-21	Print Escape Sequences	98
1-2	RS-232C Printer (DTE) Interface Connector Assignments	6	4-22	Printer Port Handshaking Protocols	101
1-3	Configuration of Current Loop Board	10	6-1	Troubleshooting Terminal Problems	112
1-4	Current Loop Computer (DCE) Interface Connector Assignments	11	C-1	ASCII Code Chart	A-6
2-1	Set Up Lines	15	C-2	ASCII Control Character Abbreviations	A-6
2-2	Changeable Values in First Set Up Line (Computer Port)	16	C-3	ASCII Code Conversion Listing	A-7
2-3	Changeable Values in Second Set Up Line (Printer Port)	18	H-1	Character Set Differences	A-19
2-4	Changeable Values in Third Set Up Line (Screen)	19	I-1	Set Up Memory Bit Map	A-24
2-5	Changeable Values in Fourth Set Up Line (Keyboard and Data	20	I-2	Character Set Bit Map	A-25
2-6	Changeable Values in Fifth Set Up Line (Miscellaneous)	22	I-3	Baud Rate Bit Map	A-25
2-7	Status Line Values	26	I-4	Contrast	A-25
2-8	Summary of Reset Methods	27			
2-9	Summary of Set Up Mode Controls	28			
3-1	Special Key Functions	30			
3-2	Alphanumeric-Type Special Key Functions	31			
3-3	Function of Special Keys Affected by Editing Mode	33			
3-4	Reset Keys	35			
3-5	Communication Modes	37			
3-6	Printing Data from the Screen	38			
4-1	Set Up Memory Bit Map	41			
4-2	Character Set Bit Map	42			
4-3	Baud Rate Bit Map	42			
4-4	Contrast	42			
4-5	Example Set Up Memory Sequence	43			
4-6	Attributes of the 25th Line	45			
4-7	Effect of Line Feed Codes on Cursor Movement	59			
4-8	Effect of Reverse Line Feed Codes on Cursor Movement	61			
4-9	Cursor Movement	63			
4-10	Default Function Key Codes	70			
4-11	Effect of ESC 1 (Set Tab Stop) Command	71			
4-12	Summary of Tabulation Commands	72			
4-13	Effect of CTRL I (Forward Tabulation) Command on Cursor Position	72			
4-14	Effect of ESC i Command on Cursor Position	73			
4-15	Effect of ESC I (Back Tab) Command on Cursor Position	74			
4-16	Effect of Edit and Protect Modes on Character Insert and Delete	79			
4-17	Effect of Protect Mode on Other Editing Commands	81			
4-18	Clear Commands	85			
4-19	Send Commands	89			
4-20	Default Delimiter Values	96			

List of Figures

1-1	Location of Screws in Cover	1	4-9	Scrolling Movement Within Page of Memory	53
1-2	Removing the Cover	2	4-10	Scrolling Movement Within a Scrolling Region	54
1-3	Interior View	2	4-11	Sample Protected Form with Spaces Left for Data Entry	55
1-4	Correct Terminal Placement	3	4-12	Line Numbers in Relation to Scrolling Region	68
1-5	Optimum Terminal Placement	3	4-13	Appearance of Printed Copy from Formatted and Unformatted Data	100
1-6	Connecting the Keyboard Cable	4	6-1	Screen During First Self Test	111
1-7	Location of Power Select Switch	4	6-2	Logic Board and Connectors	115
1-8	Power Select Switch Settings	4	6-3	Removing the Logic Board from the Card Guide	115
1-9	Pin Numbers (25-pin RS-232 Connector)	5	6-4	Power Supply Fuses	116
1-10	Rear View of Terminal	6	6-5	Good Fuse	116
1-11	Plugging the Power Cord into the Terminal and Wall Outlet	7	6-6	Burned-Out Fuse	116
1-12	Turning On the Terminal	7	6-7	Line Fuse	117
1-13	Screws Holding Logic Board and Shroud to Terminal Case	9	H-1	US ASCII Keyboard Layout	A-19
1-14	Connectors P2 and P5 on Logic Board	9	H-2	UK Keyboard Layout	A-20
1-15	Removing the Logic Board and Shroud from the Card Guide	9	H-3	French Keyboard Layout	A-20
1-16	Current Loop Board Installed on Logic Board	11	H-4	German Keyboard Layout	A-21
1-17	Notches and Depressions in Chips	12	H-5	Spanish Keyboard Layout	A-21
1-18	Removable Cover Plate on Rear Panel	12	H-6	Finnish/Swedish Keyboard Layout	A-22
1-19	Attaching the Optional European Base Plate	13	H-7	Danish/Norwegian Keyboard Layout	A-22
2-1	Initial Values of First Set Up Line	16	H-8	Portuguese Keyboard Layout	A-23
2-2	Second Set Up Line	17			
2-3	Third Set Up Line	18			
2-4	Fourth Set Up Line	19			
2-5	Fifth Set Up Line	22			
2-6	Initial Status Line	26			
3-1	Character Keys	29			
3-2	Special Keys Requiring Another Key	30			
3-3	Alphanumeric-Type Special Keys	31			
3-4	Special Keys Affected by Editing Mode	32			
3-5	Terminal Reset Keys	35			
3-6	Erasing Data	36			
3-7	Data Movement Caused by Deleting Text	36			
3-8	Data Flow	37			
3-9	Data Sent by Unshifted SEND Key	38			
3-10	Data Sent by Shifted SEND Key	38			
4-1	Typical Monitor Mode Display	40			
4-2	Display with Three Blocks of Attributes	48			
4-3	Display with Three Blocks of Graphics	49			
4-4	Special Graphics Characters	50			
4-5	Partial Page of Memory Displayed on the Screen	51			
4-6	Dividing Memory into Pages	51			
4-7	Cursor Movement During Autopage Mode	52			
4-8	Cursor Movement Between Adjacent Pages	53			

Glossary

ACK	An ASCII character meaning acknowledgement. Usually sent by the terminal to the computer indicating page print or some local function is finished.
address	Noun: A number specifying a location in the computer's memory where information is stored. Similar to a post office box number. Verb: To send something to a particular location. The addressable cursor can be sent by the computer to a specific line and column position on the screen.
alphanumeric characters	The alphabetic, numeric, and special symbol characters.
answerback	A programmable response sent to the computer upon request. Can be used to identify a particular terminal when several terminals are connected to a computer. Each terminal can be sent a unique answerback. If 50 924 terminals are connected to the computer, the fifth 924 terminal could be programmed to reply, "924 5." Answerback codes are also used with modems.
ASCII	Acronym: American Standard Code for Information Interchange , pronounced ask-key . The code structure most commonly used to represent letters, numbers, and other characters in data transmission. An ASCII character is expressed as a group of 7 bits; therefore, 128 characters can be expressed.
autowrap	A mode that allows the cursor to automatically move to the beginning of the next line after reaching the end of the cursor's current line.
baud rate	A measure of the maximum number of binary bits that can be transmitted (per second) over a line between two serial communication devices. See serial transmission.
bidirectional print	A communication mode that connects the printer port to the computer port, allowing data to flow in both directions.
bit	Acronym: binary digit . The simplest unit of data; always a one or a zero (meaning yes/no, on/off). Eight bits equal one byte, and one byte equals a character.
block attribute	An attribute that defines the visual appearance of an area of the screen. By selecting one or more visual attributes before defining the area, all data within the defined block is displayed with that visual attribute(s).
block mode	A local mode that displays on the screen text entered from the keyboard. Allows you to check and correct it before sending it as a block of data to the computer.
BREAK key	Causes the line to go to the space condition for 250 milliseconds. The computer's current operation may stop while it waits for more instructions.
buffer	A temporary storage location for data within the terminal's memory. Can be used to compensate for differences in transmission rates or temporarily store characters until the computer or printer can accept them. For example, buffers allow data to be sent from the computer to the terminal at a different baud rate than it is sent from the terminal to the printer.
buffered print	A print mode (either transparent or extension) that uses the terminal's buffer(s). This mode lets you set different baud rates between the computer and terminal and the terminal and printer. See also transparent print, extension print, and buffer.
byte	A group of bits representing a character.

Glossary Continued

connector	The physical plug that connects the cable and the electrical interface of the computer, terminal, printer, etc. For RS-232 applications, they are commonly D-shaped, and contain many pins (male connector) or holes (female connector). The number of pins varies between equipment manufacturers. TeleVideo terminals have 25-pin female connectors.
conversational mode	An interactive communications mode that lets data flow from one communications device to another. See full and half duplex modes.
copy print	Same as buffered extension print.
CRT	Acronym: cathode ray tube. A tube whose surface is the video screen in terminals and monitors.
cursor	A marker showing where the next character will normally appear. Can be blinking or steady, a block or an underline, or invisible. See also hidden cursor.
current loop	A method of sending data as 20-milliampere current pulses over a serial line (up to 700 meters). Although usually slower than RS-232, it permits accurate communication over longer distances. Either the computer or the terminal may be able to supply the current. The configuration chosen (active or passive) depends on whether the terminal or computer is supplying the power. If the terminal supplies the current, configure the terminal's current loop for active; if the computer supplies the current, configure the terminal for passive. To determine correct configuration, think of a person holding a garden hose with a nozzle on the end. If the house supplies the water pressure to the hose and the person merely opens the nozzle, the house is the active device and the person is passive device. However, if opening and closing the nozzle causes water to flow from (i.e., suctioned out of) a holding tank within the house, the person is the active device and the house is the passive device.
CTS	Acronym: Clear to Send. An RS-232 line indicating that the computer is ready to receive more data from the terminal.
DCD	Acronym: Data Carrier Detected. An RS-232 line that indicates whether or not the data carrier in the phone system is active and the device at the other end of the phone line is available.
DCE	Acronym: Data Communications Equipment. Usually the computer or the equipment connected to it.
default	A value or instruction used until otherwise defined.
delete	To remove the character/line/page at the cursor position and move the following data to take its place. Data appears to fall into a hole.
delimiter	A code transmitted at the end of a predefined area (field) of data. Could be a field, end of line, or end of text delimiter.
descender	That part of a lowercase character that hangs below the main body of the character. The tail of the lowercase y is a descender. A terminal with true descenders (such as TeleVideo's) displays the tail below the main line of text.
DIP Switches	Acronym: Dual In-Line Package. A panel of very small switches.
display	The amount of data that can be viewed on the terminal screen at one time. See also page and screen.
download	To copy (read) data from the computer into the terminal's memory.

Glossary Continued

DSR	Acronym: Data Set Ready . An RS-232 line indicating when the data coming from the computer is meant for your device.
DTE	Acronym: Data Terminal Equipment .
DTR	Acronym: Data Terminal Ready . An RS-232 line used by the terminal to tell another device such as the computer when it is ready to receive data. See also handshaking protocol.
duplex	Bidirectional communication. See conversational mode, half duplex, and full duplex.
EOM	Acronym: End of Message . An ASCII character sometimes used to mark the end of a block transmission.
EPROM	Acronym: Erasable, Programmable ROM . A read-only memory chip that can be erased and reprogrammed.
erase	To remove from memory the data starting at the cursor position through the end of the line or page and replace it with insert characters. See also delete and insert character.
escape sequence	A command introduced by an escape character to control the functions of the terminal, computer, or printer.
ETX	Acronym: End of Text . An ASCII character sent when block transmission has ended.
execute	To carry out an instruction or series of instructions.
extension print	A print mode that sends data to the printer and the screen at the same time.
field	A group of characters sharing the same write-protect attribute.
full duplex	A conversational communication mode that allows the terminal and the computer to transmit and receive simultaneously. The transmitted data is not printed locally unless it is "echoed back" by the computer.
graphics	Pictorial information; data depicted by lines and figures instead of printed characters.
graphics characters	Special characters used to draw pictures.
half duplex	A conversational communication mode that allows the terminal to transmit and receive data in separate, consecutive operations. Transmitted data can be printed locally.
handshaking protocol	Prearranged signals sent by the computer, the terminal, and the printer to control the flow of data. The signals can be ASCII characters or they can result from raising or lowering the voltages on RS-232C lines used for that purpose. These signals allow the computer and the peripherals to tell each other when they are ready to send or receive information. Prevents data from being sent when the other device is not able to accept or handle more data at that time. See also DTR, RTS, CTS, X/ON-X/OFF, DCD, and DSR.
half-dot shift	A way of designing the dot patterns of characters so they appear to have smooth instead of ragged diagonal lines.
hertz	A unit of frequency equal to one cycle per second. If the terminal's hertz rate does not match the hertz rate of the incoming alternating current, the display may waver. Abbreviated Hz.
hexadecimal	A numbering system with a base of 16. Commonly used by programmers to indicate locations and contents of a computer's memory. Uses 0 through 9 and A through F. Abbreviated hex. See ASCII Code Conversion Table in Appendix C.

Glossary Continued

home	The first character position on the page.
insert character	The character that occupies the position previously occupied by an erased character. Unless you define it, it is a space character. See also edit, delete, erase, and space.
interface	A circuit that connects devices in a computer system (i.e., the computer and peripherals). See also current loop, RS-232C, RS-422.
keyboard	The interface between the operator and the terminal's intelligence.
local mode	A mode that disables both the transmitting and receiving capabilities of the terminal's computer port. Data entries or changes go only to the screen. See also block mode and conversational mode.
menu	A displayed list of parameters from which the operator can select different values.
message line	A line containing a message to the operator from the computer program. Displayed on the screen's 25th line. Sometimes called user line.
mode	A method of operation. When the terminal is in a particular mode, it has a different reaction to some commands or situations. For instance, when the terminal is in monitor mode, it displays everything (including control codes and escape sequences), not just alphanumeric characters. The terminal can be in several modes at the same time; i.e., protect and duplex edit modes. Modes are always either on or off.
modem	Acronym: mod ulator/ dem odulator) An electronic device that allows one computer to send and receive information to another computer by encoding digital signals for use over telephone lines.
monitor	Hardware: A video screen on which you can see computer output and input.
monitor mode	A mode that allows users to see all ASCII characters as they are received.
N-key rollover	A keyboard feature that allows you to type faster than the keyboard can transmit without locking up or missing a character. Also permits you to strike a series of keys simultaneously, with the characters being transmitted in the order in which the keys are pressed.
nonvolatile memory	A permanent memory storage area. Not affected by loss of power. A RAM with a constant power source is a nonvolatile memory device.
null	An ASCII character that normally does nothing and is ignored. While a space character occupies a space, the null character is a void (nothing). Used because it occupies no space and is not transmitted.
page	As used in this manual, refers to an amount of memory. However, since the screen displays 24 lines of text at a time, you may not see the entire page. See also display, screen.
page print	A print command that sends all data on the terminal's screen between the home and cursor position to the printer connected to the terminal. Can be formatted (including line delimiters such as CR, LF, and null) or unformatted.
parity	A method of checking the data bits received to make sure they are complete and accurate. See also start bit, stop bit.
peripheral	External equipment connected to the computer. The most common peripherals are terminals, disk drives, printers, modems, and cassette-tape recorders.

Glossary Continued

port	The location at which data goes in and out of the device. See connectors.
protect mode	A mode that allows specific data to be protected from accidental operator change. Block mode transmission can exclude or only include these areas.
RAM	Acronym: R andom- A ccess M emory. The changeable part of the computer /terminal's memory. Memory that can be read and written into during normal operation. It is erased (lost) when power to the RAM chip is turned off. RAM is the type of memory used in all computers to store the instructions of programs being run. See also ROM.
read the cursor	Report the cursor's position and content to the computer.
refresh	To change or update the screen with new data.
resolution	The sharpness of the characters on the display. When a character contains a lot of small dots (pixels), it is much sharper than a character containing only a few large dots.
reverse video	A terminal feature that produces the opposite combination of characters and background from the one usually employed (i.e., light characters on a dark background if normally characters are dark on a light background).
RS-232C	A standard technical specification written by the Electronic Industry Association for data sent as voltage pulses over a serial cable at distances up to 50 feet (although shielded wires allow greater length). See also interface, current loop, RS422.
RS-422	A technical specification for high-speed communication between the computer and a peripheral. When used, sends data faster than RS-232C while allowing the peripheral to be located up to 4,000 feet from the computer. See also interface, current loop, RS-232C.
RTS	Acronym: R equest to S end. A line whose voltage changes to control data flow between computer, terminal, and printer. See also handshaking protocol.
screen	The terminal viewing area that shows 24 lines of data and one status/user/set up line. See also display and page.
screen updating	The changing of data on the terminal's screen as new data is received from the computer or printer terminal.
scroll	The action that moves lines up or down on the display so you can see data on that page of memory but just beyond the 24-line viewing area. The direction, rate, and evenness of the scrolling can be controlled. See page, screen.
scrolling region	The same area of memory as defined by page . Movement of the cursor is limited to the scrolling region.
self-test	A procedure that causes the terminal (or a program or peripheral) to check its own operation.
serial transmission	A method of sending one bit of data at a time in a stream. See parallel, RS-232C.
SET UP	In this manual, denotes a command that can also be changed in the set up lines.
set up	Refers to the mode used to change the terminal's operating parameters.
set up lines	A line that can appear on the bottom line on the screen. Contains descriptions of the terminal's ports and modes that can be changed from the keyboard. The appearance of the set up lines cannot be changed; they are always displayed in reverse video. The parameters

Glossary Continued

changed in the set up line are temporarily displayed in normal video until you leave the set up mode. When you reenter set up mode and look at that line again, that parameter is displayed in reverse video. Changes made in the set up lines are not lost when the power is turned off. See 25th line.

SOH Acronym: **Start of Header**. An ASCII character that frames the start of block of data to be transmitted. See EOM.

space A blank space created by a space character. Not the same as a null, which looks like a space but contains nothing (i.e., a void). A space occupies an amount of memory while a null does not. The terminal transmits space characters, while it does not transmit null characters.

status line A line that can appear on the bottom line on the screen. Contains descriptions of the terminal's ports and modes that can be temporarily changed from the keyboard. The appearance of the status line cannot be changed; it is always displayed in reverse video. Changes made in the status line are lost when the power is turned off. See 25th line.

start bit The space that signals the beginning of data transmission. It is always a one (1). See parity bit, stop bit.

stop bit A space that signals the end of data transmission; always a one (1). The terminal can use either one or two stop bits, depending on the computer's requirements. See parity bit, start bit.

STX Acronym: **Start of Text**. An ASCII character signalling that text transmission follows.

system sign-on message The message sent to the terminal screen by the computer when the system is first turned on (i.e., boots up).

tab stop A preset place indicating where the cursor will go when the TAB key is pressed or the terminal receives the tab command. Tab stops can be changed or deleted on command.

trace In this manual, the soldered connection between two pins.

transmit To send data between a peripheral such as the terminal and the computer.

transparent print A printer port mode that sends all data received by the terminal to the printer without displaying it on the screen. See extension print, bidirectional print, page print.

25th line The bottom line of the screen. Displays the status, set up, or message lines or can be blank. See status line, user's message line, set up line.

VDT Acronym: **video display terminal**. A terminal containing a cathode ray tube on which information received from the computer or keyboard can be displayed. Different than a terminal that uses a printer to display data. Video display terminals include a keyboard, while printer terminals may not.

visual attributes The description of a character's appearance. The character can be steady or blinking, full or half intensity, visible or blank (invisible), normal or reverse video, and underlined.

word structure The arrangement of bits in each piece of transmitted data. Consists of a start bit, the data bits, a parity bit (optional) and one or two stop bits.

X/On-X/Off ASCII characters that control data flow between terminal, printer, and computer. Any device connected to the printer port may signal the terminal to stop sending data or to resume sending data by using this signal. See also handshaking protocol and DTR.

1. Installation

Introduction

Installing the terminal involves the following steps:

- Inspecting the terminal for shipping damage
- Selecting an appropriate site
- Connecting the terminal to the computer and printer
- Turning it on

The last section summarizes the installation procedure.

WARNING! Do not open the terminal case as shown in this manual unless you are a qualified technician. Opening the case exposes you to potential shock hazards.

Inspecting the Terminal

After you unpack the terminal, keep the shipping carton and packing material to use if you move or ship the terminal again.

In the packing carton you should find the terminal, a keyboard, a coiled keyboard cable, a power cable, and the manual. If anything is missing, call your dealer.

1. Inspect the keyboard, cabinet, and video screen for shipping damage.
2. Remove the two screws on the back of the case, as shown in Figure 1-1.
3. Pull the cover gently toward you and up to remove the top of the case (Figure 1-2).

STOP! Keep your hands out of the case. If the CRT is broken, do not touch any fragments since they are extremely sharp and the tube's inner coating is poisonous.

4. Visually inspect the CRT (Figure 1-3). If it is cracked or broken, call a service technician.
5. Replace the cover and screws.

Figure 1-1
Location of Screws in Cover

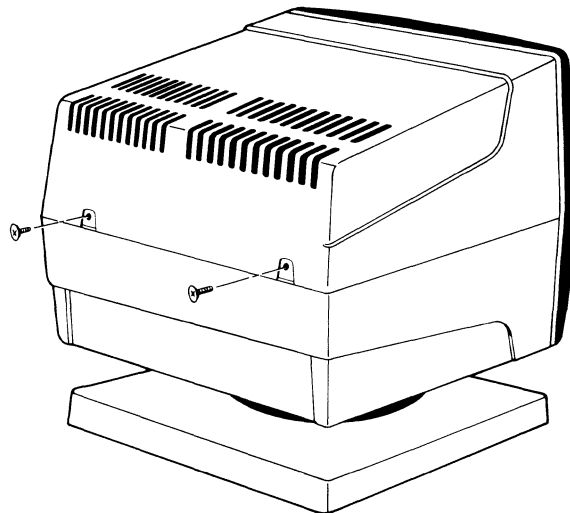

Figure 1-2
Removing the Cover

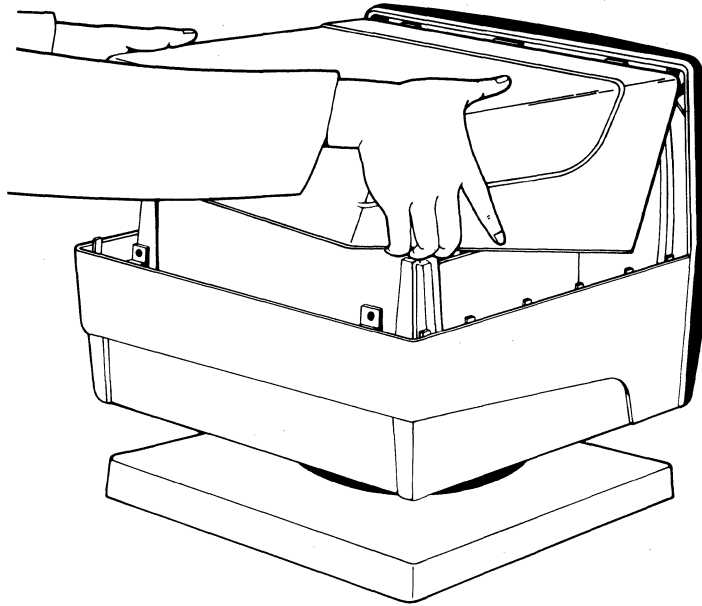
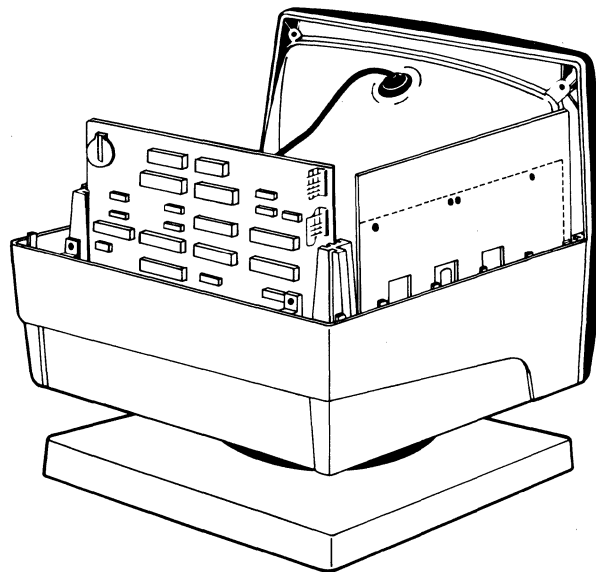

Figure 1-3
Interior View



Selecting a Good Location

Although the 924 was designed with your comfort in mind, where you place the terminal can also affect your comfort. Choose a site with indirect lighting, away from windows and other sources of bright light, as shown in Figure 1-4. Reflections and bright light are the most common causes of eye strain.

Figure 1-4
Correct Terminal Placement

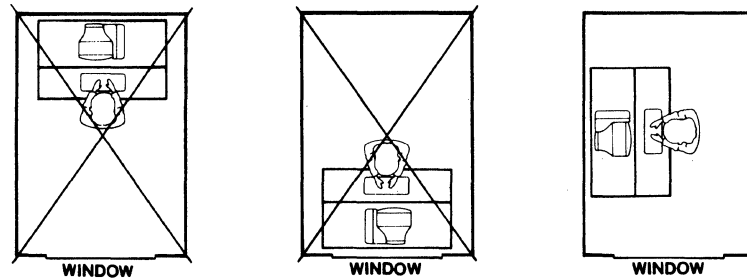

Prevent operator fatigue by selecting furniture whose design is conducive to good working posture and placing the terminal at the correct height. Figure 1-5 shows the ideal relationship between the terminal and the operator. Since a high keyboard would be awkward for the operator, the keyboard is lower than the terminal screen.

Figure 1-5
Optimum Terminal Placement

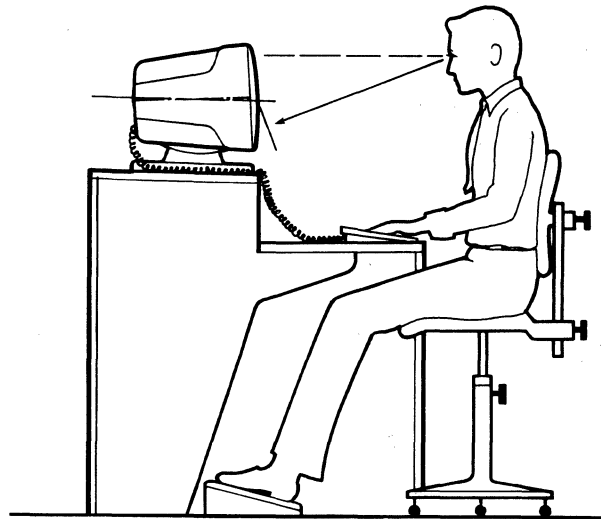

Space Requirements

Allow 4 inches (10.2 cm) around the terminal for ventilation.

Installing the Terminal

Connecting the Keyboard

Plug the ends of the coiled keyboard cable into the back of the keyboard case and the back of the terminal (Figure 1-6).

Figure 1-6
Connecting the Keyboard Cable

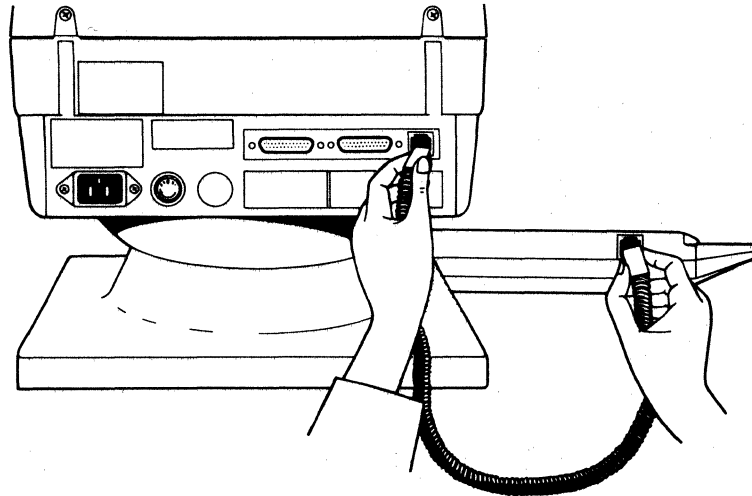

Setting the Power Select Switch

The 924 requires 115 volt (60 hertz) or 230 volt (50 hertz) ac power.

1. Look at the power select switch under the left rear of the terminal (Figure 1-7). A blocking strip holds the power select switch in position for either 115 volt (US) or 230 volt (international) operation.
2. Remove the blocking strip and change the power select switch, if necessary. Figure 1-8 shows the two possible switch positions.
3. Replace the blocking strip.

Figure 1-7
Location of Power Select Switch

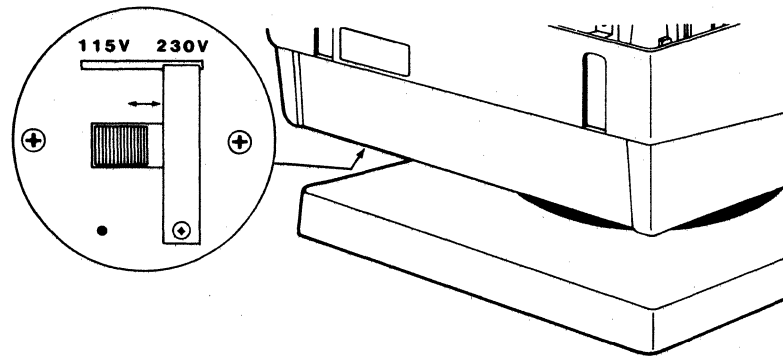
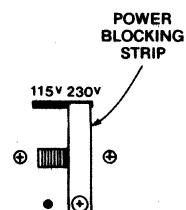
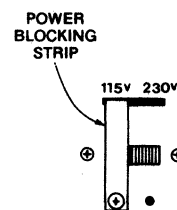

Figure 1-8
Power Select Switch Settings

115 Volt Operation



230 Volt Operation



If you need a neutral fuse to meet international standards, ask your service technician to install it for you.

Connecting the Terminal to a Computer System

Measure the distance between the terminal and computer or modem before connecting them. You can use an RS-232C interface cable (with a 25-pin connector) between the terminal and the computer if the distance is less than 50 feet and the baud rate is 9600 or less. For distances between 50 and 1,000 feet, install a current loop board, as described in the section on field modifications.

If you are able to use the RS-232C cable, follow these steps:

1. Compare the suggested pin connector assignments, listed in Table 1-1, with those required by your computer. (Figure 1-9 shows the pin numbers assigned to the terminal's pin connectors.) If necessary, change the interface cable's pin assignments or ask your service technician to do it for you.
2. Connect the interface cable to the terminal's port labeled RS232 (Figure 1-10) and to the computer's RS-232C port.

NOTE! *Not all computers have a one-to-one pin compatibility with standard RS-232C pin assignments. Only pins 2, 3, 7, and 20 are required to transmit data between the terminal and the computer. If your computer fails to operate properly, call the computer manufacturer for assistance in wiring the interface cable. If the pin connections are correct but the computer still fails to operate properly, call TeleVideo for technical assistance.*

Table 1-1
RS-232C Computer (DCE) Interface Connector Assignments

Pin No.	Signal Name ¹	Direction
1	Frame Ground	
2 ²	Transmit Data	Output
3 ²	Receive Data	Input
4	Request to Send	Output
5	Clear to Send	Input
6	Data Set Ready	Input
7 ²	Signal Ground	
8	Data Carrier Detect	Input
20 ²	Data Terminal Ready	Output

1. Refer to the EIA's Standard RS-232C for signal definitions.
2. The terminal requires these signals.

Figure 1-9
Pin Numbers (25-pin RS-232 Connector)

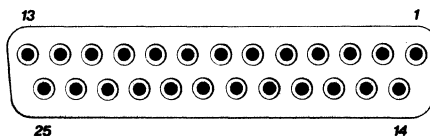
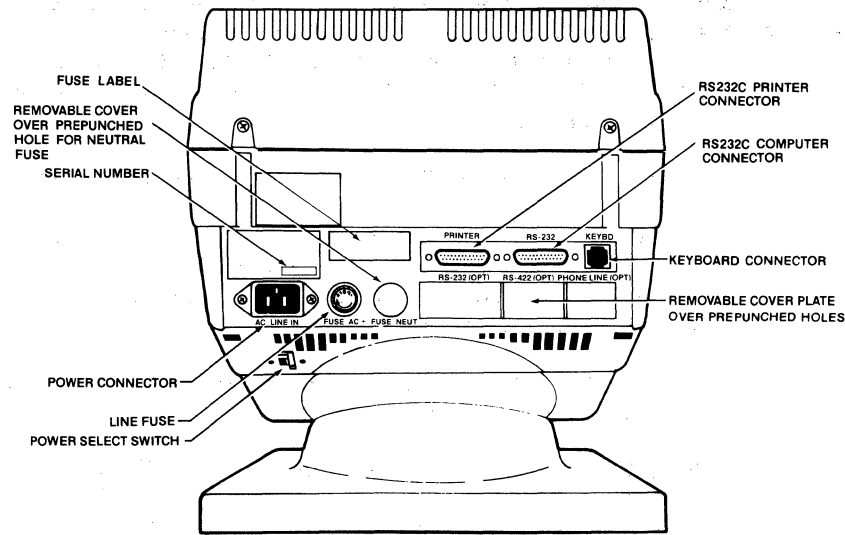

Figure 1-10
Rear View of Terminal



Connecting the Terminal to a Printer

1. Check your printer's pin connector configuration with the pin assignments of the terminal's printer port (Table 1-2).
2. Connect an RS-232C interface cable which includes a 25-pin connector to the terminal's port labeled RS232 (Figure 1-10) and to an RS-232C-compatible serial printer.

NOTE! Not all printers have a one-to-one pin compatibility with standard RS-232C pin assignments. Only pins 3 and 7 as well as 2 and/or 20 are required to transmit data from the terminal to the printer. If your printer fails to operate properly, call the printer manufacturer for assistance in wiring the interface cable. If the pin connections are correct but the printer still fails to operate properly, call TeleVideo for technical assistance.

Table 1-2
RS-232C Printer (DTE) Interface Connector Assignments

Pin No.	Signal Name ¹	Direction
1	Frame Ground	
2	Receive Data	Input
3	Transmit Data	Output
4	Request to Send	Input
5	Clear to Send	Output
6	Data Set Ready	Output
7	Signal Ground	
8	Data Carrier Detect	Output
11	Printer Busy ²	
20	Data Terminal Ready	Input

1. Reference EIA Standard RS-232C for signal definitions.
2. Nonstandard handshaking signal used by several printers such as Epson, Texas Instruments, and Okidata. To use pin 11 instead of pin 20, remove the logic board (as described in the field modification section). Either add a jumper to the logic board at P3 between W8A and W8B or cut the trace at P4 between W7A and W7B and add a jumper between W7C and W7D.

Plugging In and Turning On the Terminal

Now you are ready to plug in the terminal and turn it on.

1. Plug the power cable into the terminal and into a grounded wall outlet (Figure 1-11).

In the United States, use a 3-prong electrical outlet with a National Electrical Manufacturers Association (NEMA) Standard 5-15R rating. If you use a two-prong adapter, ground it with a pigtail.

Internally, the power cord wires have the following color codes:

Green	Earth ground
Black/red	Primary power (hot)
White	Primary power return (neutral)

2. Push the white dot on the ON/OFF switch on the front of the terminal (Figure 1-12).
3. Listen for the terminal to "beep" within about a second.
4. Look for the cursor in the top left corner of the screen after 10 to 15 seconds.
5. Adjust the angle of the terminal by pushing on the case until you can see the screen easily. The terminal case tilts and swivels on the base.

Figure 1-11
Plugging the Power Cord into the Terminal and Wall Outlet

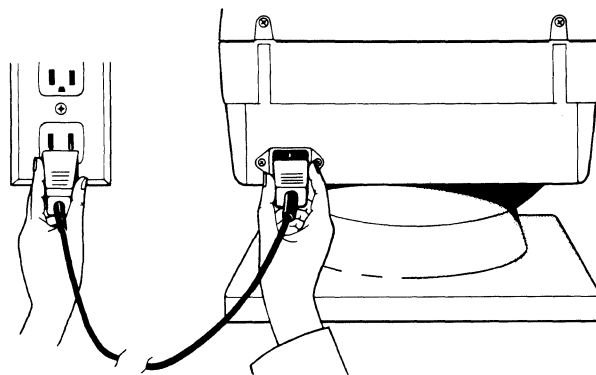
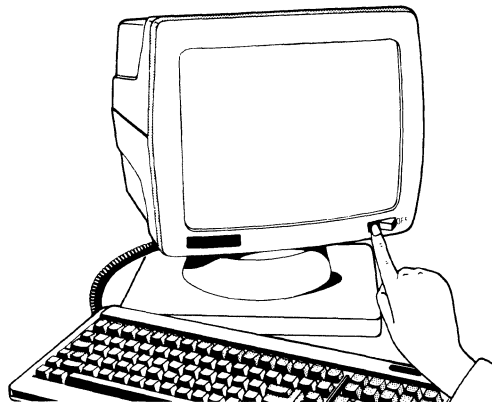

Figure 1-12
Turning On the Terminal



Before operating the terminal, check its configuration, as described in the following chapter.

Field Modifications

By following the instructions in this section, you can modify the terminal or add several options at any time. As you perform these modifications, refer to the next section whenever you need to open the case and remove the logic board.

NOTE! *Unless you are an experienced service technician, ask your dealer or distributor to perform these modifications for you.*

General Instructions

1. Disconnect all interface cables and the keyboard cable.
2. Unplug the terminal from the wall outlet.
3. Unscrew the two Phillips head screws holding on the terminal cover (Figure 1-1).
4. Lift the cover toward you and up (Figure 1-2).

STOP! *Do not touch the video module (shown in Figure 1-3) or the black suction cup connected to the top of the CRT (which can retain an electrical charge of up to 15,000 volts—even with the power turned off—unless a qualified technician discharges the voltage first).*

5. If the modification does not involve removing the logic board, skip to Step 9.

If the modification requires removing the logic board, remove the two screws holding the logic board and shroud on the terminal case (Figure 1-13).

6. Disconnect the white video connector from location P2 on the logic board (Figure 1-14).
7. Disconnect the red power supply connector from location P5 on the logic board (Figure 1-14).

NOTE! *Although two connectors are attached to the internal power supply, only one (either one) is attached to the board. The other connector is tied back.*

8. Lift the shroud and logic board out of the card guide, as shown in Figure 1-15.
9. Follow the specific field modification instructions.
10. If you disconnected the video and power supply connectors and removed the logic board and shroud (Steps 5 through 7), follow Steps 11 through 17. Otherwise, skip to Step 15.
11. Slide the logic board back into the center slot on the card guides (Figure 1-15).
12. Position the shroud between the logic board and case back, matching the connector and screw holes.
13. Replace the two screws in the shroud lip and back case.
14. Reattach the white video connector to P2 and the red power supply connector to P5 (Figure 1-14).
15. Replace the cover and screws, being careful not to overtighten the screws.
16. Reattach the interface and keyboard cables.
17. Plug the power cord into the terminal and wall outlet.

Figure 1-13
Screws Holding Logic Board and Shroud to Terminal Case

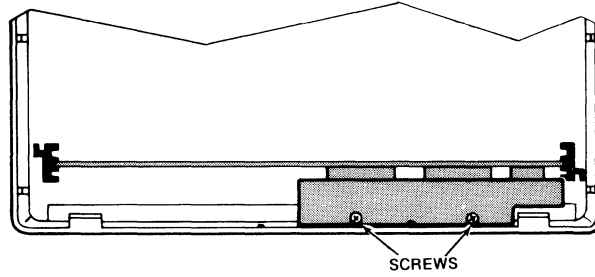

Figure 1-14
Connectors P2 and P5 on Logic Board

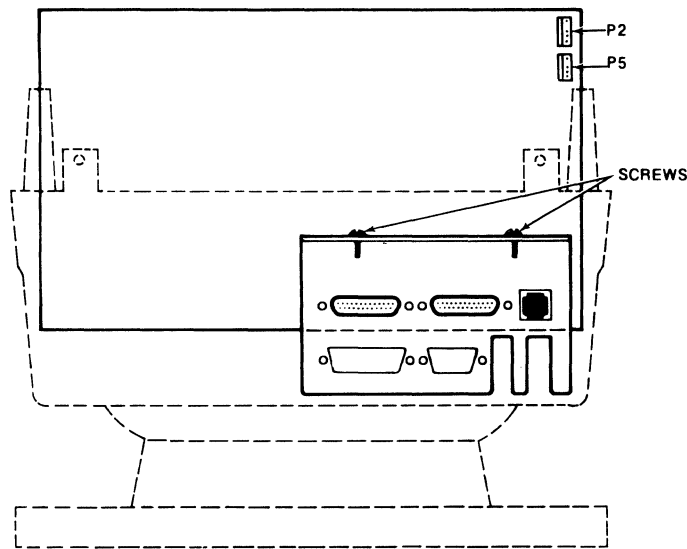
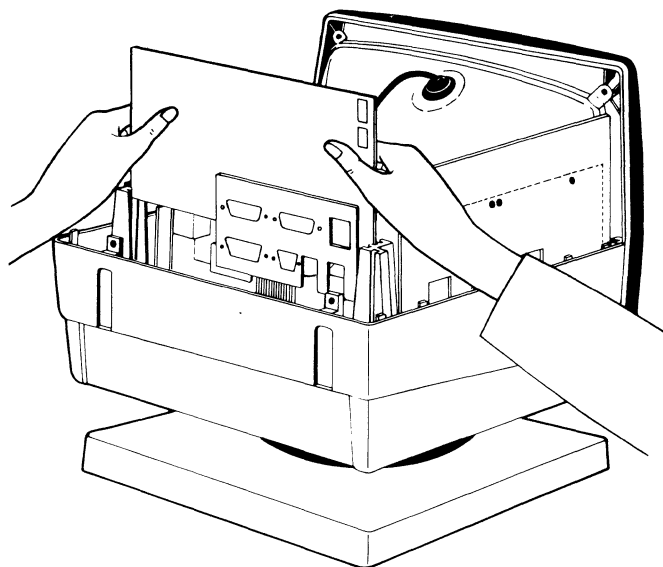

Figure 1-15
Removing the Logic Board and Shroud from the Card Guide



Current Loop

If your installation requires a current loop interface, order a current loop kit (TeleVideo Part 2131000) from your dealer.

Either the terminal or the computer must provide a 20 mA current source to drive a current loop signal. If the terminal provides the current source, the configuration is **active**. If the computer provides the current source, the configuration is **passive**.

STOP! *If you select full duplex current loop configuration, do not configure the set up line for half duplex or use the escape sequence for half duplex (ESC D H). To do so could seriously damage both the terminal and the computer.*

Consult your computer's documentation if you are not sure if the computer can provide the current.

1. Based on that information, choose **one** of the following configurations:

Full duplex, active transmit, active receive

Full duplex, active transmit, passive receive

Full duplex, passive transmit, active receive

Full duplex, passive transmit, passive receive

Half duplex, active transmit/receive

Half duplex, passive transmit/receive

2. Modify the current loop board, as described in Table 1-3.

Table 1-4 lists the pin connector assignments of the RS-232C port when it is configured for current loop.

3. Connect the current loop board's pin connector to the socket labeled P6 on the logic board. See Figure 1-16.
4. Assemble the two boards, together with the spacer, washers, and nut, as shown in Figure 1-16. Insert and tighten the screw.
5. Follow the general instructions to reassemble the terminal.
6. Connect the terminal's computer port, labeled RS232 (Figure 1-10), and the computer's RS-232C port, using a 25-pin RS-232C interface cable.

Table 1-3
Configuration of Current Loop Board

Configuration	20 mA Current Source ¹	Cuts	Jumpers	Pin No. ²	Connector Polarity
Full duplex transmit	Active	W2 to W3	W1 to W2 W3 to W4	13 25	+ -
	Passive	—	—	25 13	+ -
Full duplex receive	Active	W6 to W7	W5 to W6 W7 to W8	24 12	+ -
	Passive	—	—	12 24	+ -
Half duplex transmit/receive	Active	—	W1 to W2 P3-12 to P3-13	24 7	+ -
	Passive	—	P3-12 to P3-13	25 24	+ -

1. Where the source is the terminal.
 2. In the interface connector.

Table 1-4
Current Loop Computer (DCE) Interface Connector Assignments

Pin No.	Signal Name	Direction
9	20 mA source (+ 12V, no load)	
10	Detected Current Loop Data	
12	Current Loop	Receive
13	Current Loop	Transmit
14	20 mA source (+ 12V, no load)	
24	Current Loop	Receive
25	Current Loop	Transmit

Figure 1-16
Current Loop Board Installed on Logic Board

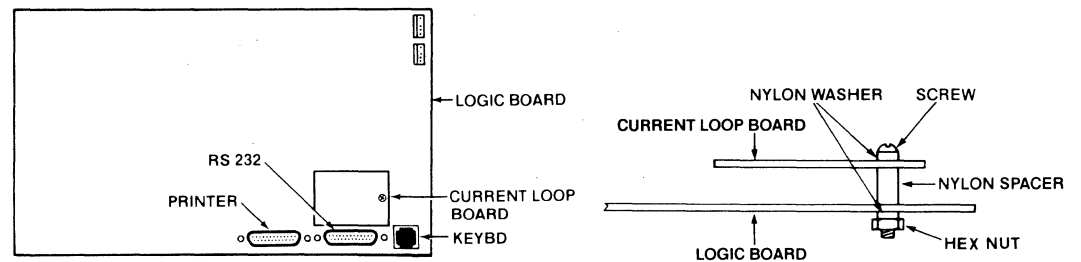

Adding More Screen Memory

You can install more screen memory in the terminal. If you ordered the terminal with additional memory, this modification has already been made.

You need two 8k x 8 (64k bit) static RAM chips with a maximum access time of 150 nanoseconds (TeleVideo Part 132093-00).

1. Open the case and remove the logic board as described in the general instructions.
2. Cut the traces between W1B and W1C and between W4B and W4C. Add a jumper between W1A and W1C and between W4A and W4C.
3. Replace the chips at locations U4 and U11 on the logic board with the new chips. You can discard the original chips.

NOTE! Handle the chip carefully to avoid bending the pins. Make sure the chip's half-moon notch or depression (Figure 1-17) matches the orientation of the other chips.

4. Replace the logic board and cover, as described in the general instructions at the beginning of this section.

Figure 1-17
Notches and Depressions in Chips

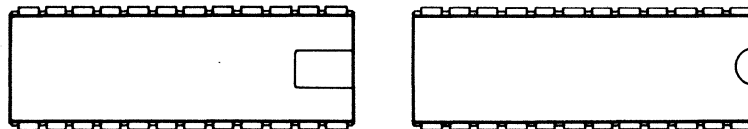

Adding a Monitor

The composite video option allows you to connect an additional monitor to the terminal. You need an Amphenol BNC connector, Part 227169-5.

1. Open the case and remove the shroud and logic board, following the general instructions at the beginning of this section.
2. Gently pry off the cover plate below the pin connectors (Figure 1-10), exposing the four punched holes shown in Figure 1-18.

Figure 1-18
Removable Cover Plate on Rear Panel

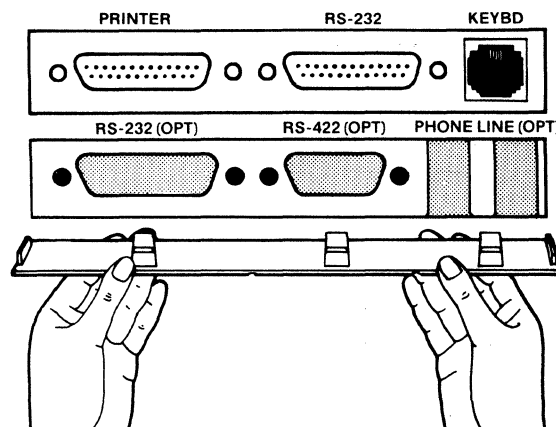

3. Install the BNC connector in the opening labeled RS422 (OPT).
4. Connect the center lead of the BNC connector to P10 pin 1 on the logic board. Connect the BNC ground lead to P10 pin 2 on the logic board.
5. Break apart the scored cover plate to expose the hole where you installed the BNC connector. Snap the other cover plate sections back in place.
6. Replace the logic board and cover, following the general instructions at the beginning of this section.
7. Install a coaxial cable less than 10 feet long between the terminal's BNC connector and the monitor.

Adding a European Base Plate

The optional European base plate raises the height of the terminal by doubling the thickness of the base. The only tool you need is a small Phillips head screwdriver.

1. Unplug the terminal from the wall outlet.
2. Carefully turn the terminal on its side.
3. Remove the small Phillips head screw inside each rubber foot. Lay the feet aside.
4. Hold the European base plate against the conventional base. Install the four screws (supplied in the kit) in the small holes near the holes for the feet (Figure 1-19).
5. Position a rubber foot over each outer hole and replace the screws removed from the conventional base plate.
6. Return the terminal to its upright position and plug in the power cord again.

Figure 1-19
Attaching the Optional European Base Plate

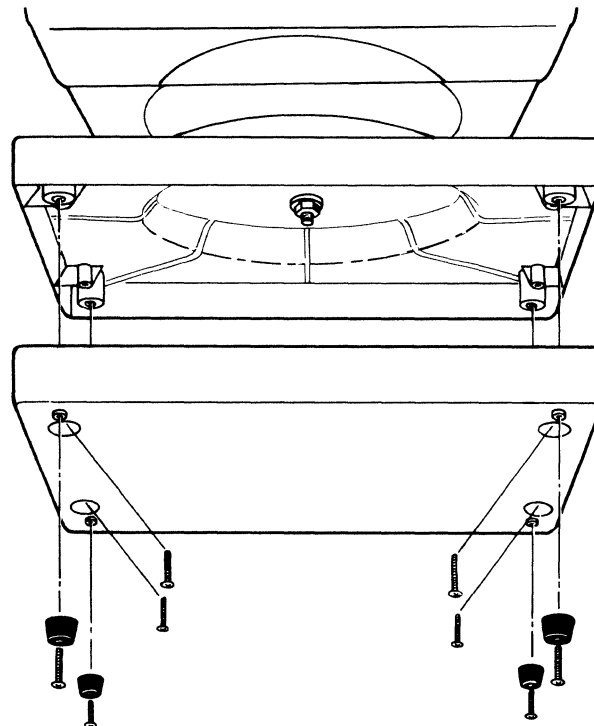

**Installation
Summary**

- Plug the keyboard cable into the terminal and the keyboard.
- Check the power select switch setting.
- Connect the appropriate interface cable between the computer system and the terminal.
- Attach a printer interface cable (if you are connecting a printer to the terminal).
- Plug the power cord into both the terminal and the wall outlet.
- Turn on the terminal and watch for the cursor to appear.

2. Reconfiguring the Terminal

Why Reconfiguration Is Necessary

When you receive the terminal, its operating values are already set. This is its **configuration**. However, that configuration may not necessarily fit the requirements of your computer and printer. After checking these requirements, you will probably need to reconfigure the terminal so it can communicate with them.

How To Reconfigure the Terminal

Selecting a Method

You must initially reconfigure the terminal by changing values in the five set up lines that can be displayed on the screen's bottom (25th) line. After that you can reconfigure the terminal with the set up lines or the status line (a one-line summary of a few current terminal parameters).

Changing the status line only changes the terminal's current configuration; not its permanent (i.e., nonvolatile) memory. As soon as you turn the terminal off, any changes not stored in the nonvolatile memory are lost. The next time you turn the terminal on, its configuration returns to the values in effect before you changed the status line.

NOTE! *The current configuration is also changed when the terminal receives an escape sequence from the computer or the keyboard.*

Changing the set up lines (in set up mode as described here or with the sequence ESC } <code> described in Chapter 4) changes both the terminal's current configuration (as shown in the status line) and its nonvolatile memory.

Changing the Set Up Lines

NOTE! *Although you can put the terminal in set up mode at any time, you should wait until any data transmission in progress is finished.*

1. Press SHIFT and SET UP at the same time. This puts the terminal in set up mode.

STOP! *Unless you press the SHIFT key while pressing the SET UP key, you may stop all data transmission from the computer to the terminal.*

2. Look for the cursor in the status line.
3. Press the n or N key to look at the next 25th line (which is the first set up line).

Each set up line relates to a particular area of the terminal, as listed in Table 2-1.

4. Look for the cursor in the second field in the first set up line. (Figure 2-1 shows the initial display of the first set up line.)
5. Press the t or T key (for toggle) until the desired field value appears. Table 2-2 lists all the field values for the first set up line.

Table 2-1
Set Up Lines

Set Up Line	Changes
1	Computer port
2	Printer port
3	Screen
4	Page handling and keyboard
5	Miscellaneous

6. Move the cursor to the next field with a cursor control key (← and →). Then press the t or T key again to select another value.
7. Make sure the values selected for the field names shown in boldface type in Table 2-2 match the requirements of your computer and printer.

NOTE! *These fields have no right or wrong values except in relationship to your computer and printer.*

8. Press the ↑ and ↓ keys if you want to change the screen's brightness.
9. Press the n or N key to see the next set up line. Figures 2-1 through 2-5 show the initial values of the five set up lines.
10. Review the values in all five set up lines. Tables 2-2 through 2-6 describe the possible values.
11. Press the l or L key (for last) to see the previous set up line.
12. Press SHIFT and SET UP to leave set up mode and return the cursor to the main part of the screen.

Figure 2-1
Initial Values of First Set Up Line

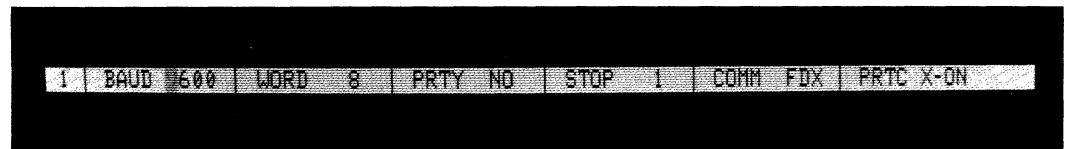

Table 2-2
Changeable Values in First Set Up Line (Computer Port)

Field Name ¹	Possible Values	Description
BAUD rate of computer port	150 300 1200 1800 2400 4800 9600 19.2k	Sets baud rate (speed at which data is sent to the computer from the terminal's RS-232C computer port).
WORD structure of computer port	8 7	Computer port recognizes/transmits only 8-bit words to/from computer. Computer port recognizes/transmits only 7-bit words to/from computer.

1. Values of fields in bold print must match computer's requirements before communication can occur.

Table 2-2
Continued

Field Name¹	Possible Values	Description
PRTY (parity of computer port)	NO	No parity.
	ODD	Parity is odd.
	EVEN	Parity is even.
STOP bits for computer port	1	Sends a bit (always with a value of one) to signal that a character has been sent.
	2	Sends two bits (both ones) to signal that a character has been sent.
COMM (communication mode)	FDX	Permits simultaneous transmission and reception of information. Keyboard entries are sent only to computer.
	HDX	Lets terminal transmit or receive data (but not simultaneously). Sends keyboard entries to computer and to screen. STOP! <i>If you selected full duplex current loop configuration, do not configure the set up line for half duplex or use the escape sequence for half duplex (ESC D H) or you could seriously damage both the terminal and the computer.</i>
	BLK	Sends keyboard entries to screen only.
	PRTC (print control)	X-ON
	DTR	Lets terminal control the receipt of data by lowering and raising voltage on the DTR line to computer.

1. Values of fields in bold print must match computer's requirements before communication can occur.

Figure 2-2
Second Set Up Line

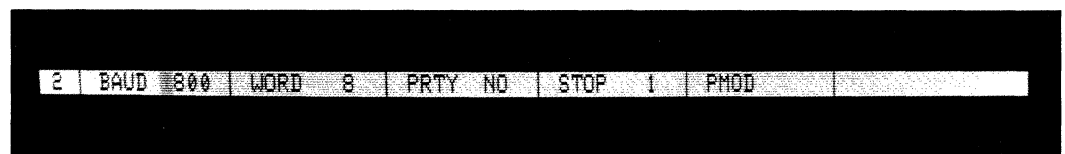

Table 2-3
Changeable Values in Second Set Up Line (Printer Port)

Field Name ¹	Possible Values	Description
BAUD rate of printer port	150	Sets baud rate (speed at which data is sent is sent to printer from terminal's printer port).
	300	
	1200	
	1800	
	2400	
	4800	
	9600	
WORD structure of printer port	19.2k	Printer port sends only 8-bit words to printer.
	8	
	7	
PRTY (parity of printer port)	NO	No parity.
	ODD	Parity is odd.
	EVEN	Parity is even.
STOP bits for printer port	1	Causes terminal to send a bit with a value of one when a character code has been sent.
	2	Sends two bits (both ones) to signal that a character has been sent.
PMOD ² (print mode)	blank	No print mode.
	TRSP	Turns on transparent print mode. Terminal does not display data on screen as it is printed. Lets baud rates of computer and printer ports differ.
	BDIR	Turns on bidirectional communication between computer and printer ports so two-way communication can occur between the computer and a printer connected to terminal.
	COPY	Turns on extension print mode so terminal displays data on screen as it is printed. Lets baud rates of computer and printer ports differ.

NOTE! Enabling bidirectional communication automatically configures the printer port with the configuration of the computer port. Disabling bidirectional communication returns the printer port to its previous configuration.

1. Values of fields in bold print must match the printer's requirements before communication can occur.
2. Refer to Chapter 4 for a detailed description of print modes.

Figure 2-3
Third Set Up Line

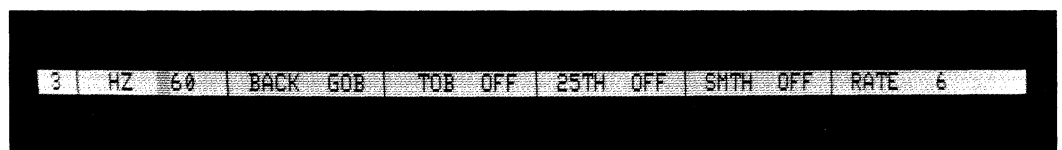

Table 2-4
Changeable Values in Third Set Up Line (Screen)

Field Name	Possible Values	Description
Hertz	60 ¹	Terminal refreshes screen at 60 hertz.
	50 ¹	Terminal refreshes screen at 50 hertz.
BACKground	GOB	Screen background is dark with light characters.
	BOG	Screen background is light with dark characters.
TOB (time out blank)	OFF	Screen remains on even while terminal is idle.
	ON	If the terminal receives no data from the computer or the keyboard for 15 minutes, the screen becomes blank. When you press any key, the terminal does not display the key's character or transmit its code to the computer—it only turns on the screen. The exception is CTRL RESET, which also resets the terminal.
25TH	OFF	Twenty-fifth line is blank.
	ON	Twenty-fifth line display is on. Displays status line unless you display set up lines or the program turns it off.
SMTH (smooth scroll)	OFF	Screen scrolls normally (not smoothly). (Sometimes called jump scroll .) NOTE! While this parameter is off, setting the rate of scroll (next field) has no effect.
	ON	Screen scrolls smoothly. NOTE! Set the scrolling rate in the next field.
RATE of scrolling	6	Data scrolls at rate of 6 lines per second (if smooth scroll is on).
	12	Data scrolls at rate of 12 lines per second (if smooth scroll is on).

1. Unless this value matches your power line's hertz rate, the screen display may waver.

Figure 2-4
Fourth Set Up Line

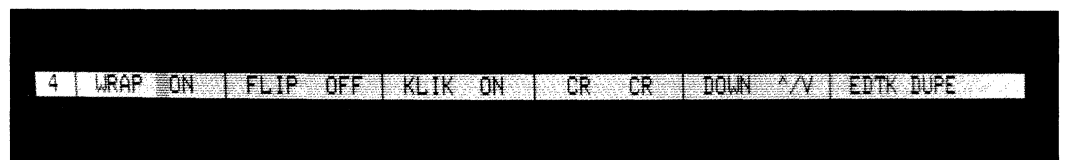
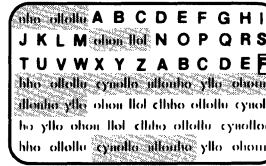

Table 2-5
Changeable Values in Fourth Set Up Line (Keyboard and Data Handling)

Field Name	Possible Values	Description
WRAP (autowrap mode)	ON	When you enter a character after the cursor reaches the line's last position, the cursor automatically advances to the first unprotected character position on the next scrollable line. ¹



BEFORE



AFTER

If autopage and write protect modes are off but protect mode is on, entering a character on the page's last unprotected position returns the cursor to the page's first unprotected position.

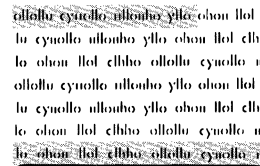

BEFORE

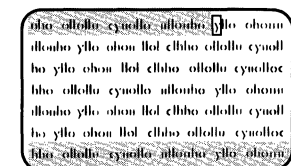

AFTER

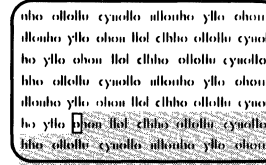

BEFORE

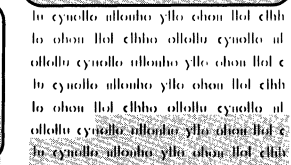

AFTER

If write protect and protect modes are on and autopage mode is off, entering a character on the line's last unprotected position moves the cursor to the page's next unprotected position.

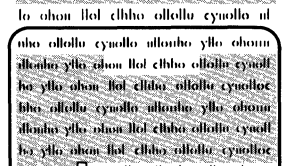
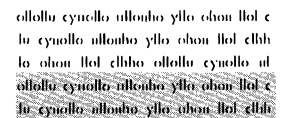
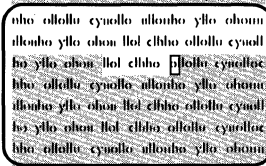
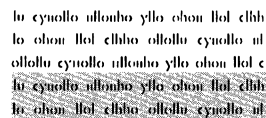

¹ Chapter 4 discusses autopage, write protect, and protect modes.

Table 2-5
Continued

Field Name	Possible Values	Description
WRAP	ON	<p>If no unprotected positions exist, the terminal turns off write protect and protect modes. (If autopage mode is on, the cursor advances to the next page's first unprotected position.)</p>
	<div style="display: flex; justify-content: space-around;"> <div style="border: 1px solid black; padding: 5px; width: 45%;"> <p>lo ohou llol elhho ollollu cyuollo ul ollollu cyuollo ullouho ylllo ohou llol c lu cyuollo ullouho ylllo ohou llol elhh lo ohou llol elhho ollollu cyuollo ul oho ollollu cyuollo ullouho ylllo ohou ullouho ylllo ohou llol elhho ollollu cyuoll ho ylllo ohou llol elhho ollollu cyuollac hho ollollu cyuollo ullouho ylllo ohou ullouho ylllo ohou llol elhho ollollu cyuoll ho ylllo ohou llol elhho ollollu cyuollac hho ollollu cyuollo ullouho ylllo ohou lu cyuollo ullouho ylllo ohou llol elhh lo ohou llol elhho ollollu cyuollo ul ollollu cyuollo ullouho ylllo ohou llol c</p> <p style="text-align: center;">BEFORE</p> </div> <div style="border: 1px solid black; padding: 5px; width: 45%;"> <p>lo ohou llol elhho ollollu cyuollo ul ollollu cyuollo ullouho ylllo ohou llol c lu cyuollo ullouho ylllo ohou llol elhh lo ohou llol elhho ollollu cyuollo ul oho ollollu cyuollo ullouho ylllo ohou ullouho ylllo ohou llol elhho ollollu cyuoll ho ylllo ohou llol elhho ollollu cyuollac hho ollollu cyuollo ullouho ylllo ohou ullouho ylllo ohou llol elhho ollollu cyuoll ho ylllo ohou llol elhho ollollu cyuollac hho ollollu cyuollo ullouho ylllo ohou lu cyuollo ullouho ylllo ohou llol elhh lo ohou llol elhho ollollu cyuollo ul ollollu cyuollo ullouho ylllo ohou llol c</p> <p style="text-align: center;">AFTER</p> </div> </div>	
FLIP	OFF	<p>Each character entered after the cursor reaches the line's last position replaces the one previously entered there.</p> <p>When cursor reaches last the unprotected position on the current line while write protect and protect modes are on, it writes data there before moving to the page's next unprotected position.</p>
	<div style="display: flex; justify-content: space-around;"> <div style="border: 1px solid black; padding: 5px; width: 45%;"> <p>oho ollollu cyuollo ullouho ylllo ohou ullouho ylllo ohou llol elhho ollollu cyuoll ho ylllo ohou llol elhho ollollu cyuollac hho ollollu cyuollo ullouho ylllo ohou ullouho ylllo ohou llol elhho</p> <p style="text-align: center;">BEFORE</p> </div> <div style="border: 1px solid black; padding: 5px; width: 45%;"> <p>oho ollollu cyuollo ullouho ylllo ohou ullouho ylllo ohou llol elhho ollollu cyuoll ho ylllo ohou llol elhho ollollu cyuollac hho ollollu cyuollo ullouho ylllo ohou ullouho ylllo ohou llol elhho</p> <p style="text-align: center;">AFTER</p> </div> </div>	
FLIP	OFF	<p>Turns off autopage mode. If memory contains more than one page, data scrolls up when the cursor tries to go past the page's last line.¹</p>
	ON	<p>Turns on autopage mode. If memory contains more than one page, receipt of a line feed or reverse line feed code or data (via keyboard or computer) by terminal scrolls display to end of the current page (if it contains more than 24 lines). When the cursor reaches the end of the page, the display shows first 24 lines of the next page.¹</p>
KLIK	ON	<p>Lets all keys click when pressed.</p>
	OFF	<p>Keeps keys from clicking when pressed.</p>

1. Chapter 4 discusses autopage, write protect, and protect modes.

**Table 2-5
Continued**

Field Name	Possible Values	Description
CR ²	CR	When the terminal receives a carriage return code from the computer, the cursor returns to the current line's first position; it does not advance to the next line. ³ Pressing the RETURN key sends only a carriage return code.
	CRLF	When the terminal receives a carriage return code from the computer, the cursor moves to the beginning of the next line (i.e., the terminal performs a carriage return and then a line feed). ³ Pressing the RETURN key sends a carriage return code.
DOWN	^/V	The ↓ key sends a cursor down code (CTRL V). ³
	^/J	The ↓ key sends a line feed code (CTRL J) instead of cursor down code (CTRL V). ³
EDTK	DUPE	Codes sent by editing keys affect terminal and are also transmitted to computer (except in block mode).
	LOCE	Codes sent by editing keys affect terminal but are not transmitted to computer.

2. Values of fields in bold print must match computer's requirements before communication can occur.
3. A line feed code is commonly used as a delimiter by computers. Some computers automatically add a line feed code (CTRL J) to each carriage return code. Others automatically add a carriage return code to each line feed code. Consult your computer's documentation before selecting a value.

**Figure 2-5
Fifth Set Up Line**

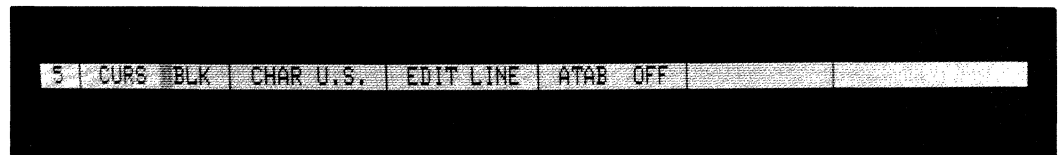
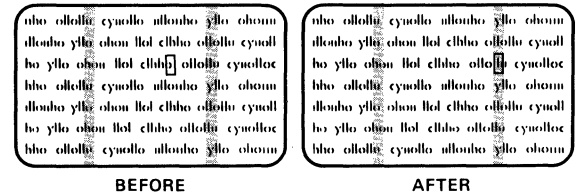

**Table 2-6
Changeable Values in Fifth Set Up Line (Miscellaneous)**

Field Name	Possible Values	Description
CURS	BBLK	Cursor is a blinking block.
	SBLK	Cursor is a steady block.
	BUND	Cursor is a blinking underline.
	SUND	Cursor is a steady underline.

Table 2-6
Continued

Field Name	Possible Values	Description
CHAR ¹	U.S.	Character set is US English (ASCII).
	U.K.	Character set is United Kingdom English.
	FREN	Character set is French.
		NOTE! If the terminal receives a caret code (5E hex) when the character set is French, the caret is displayed but the cursor does not move until the terminal receives the next input character. If that is a lowercase vowel, it is displayed with the caret above it and the cursor moves. If it is not a lowercase vowel, the caret disappears and the second character is displayed alone.
	GERM	Character set is German.
	SPAN	Character set is Spanish.
		NOTE! If the terminal receives an accent mark code (60 hex) while the character set is Spanish, it is displayed but the cursor stays there until the terminal receives the next input character. If that is a lowercase vowel, it is displayed with an accent mark above it and the cursor moves. If it is not a lowercase vowel, the terminal ignores the accent character and displays the second character.
	FIN/SWED	Character set is Finnish/Swedish.
	DAN/NORW	Character set is Danish/Norwegian.
	PORT	Character set is Portuguese.
EDIT modes	LINE	Enables line edit mode so character insert/delete commands affect only current line. ²
	PAGE	Enables page edit mode so character insert/delete commands affect the entire page. ²
ATAB (autotab mode)	OFF	Disables autotab mode. The cursor tabulates forward or backward only within the current line.



When no more tab stops exist in that line, the cursor stops responding to tab commands.

1. See Appendix H for character set differences and keyboard layouts.
 2. Edit modes are discussed in Chapter 4.

**Table 2-6
Continued**

Field Name	Possible Values	Description
ATAB	ON	Enables autotab mode if protect mode is off. Permits the cursor to tabulate to the next typewriter tab stop on the next or previous line. ³

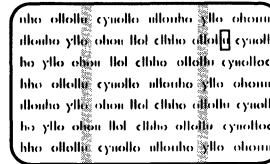

BEFORE

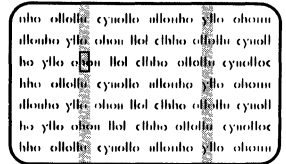

AFTER

If autopage mode is off when the cursor reaches the page's last tab stop, the cursor does not move any further.

lo ohou llo ellho ollollu cyuollo ul
ollollu cyuollo ullonho ylo ohou llo c
lu cyuollo ullonho ylo ohou llo ellh
lo ohou llo ellho ollollu cyuollo ul
ollollu cyuollo ullonho ylo ohou llo c
lu cyuollo ullonho ylo ohou llo ellh
lo ohou llo ellho ollollu cyuollo ul



BEFORE AND AFTER

If autopage mode is on, the cursor tabulates to the first tab stop on the first line of the next page.

lo ohou llo ellho ollollu cyuollo ul
ollollu cyuollo ullonho ylo ohou llo c
lu cyuollo ullonho ylo ohou llo ellh
lo ohou llo ellho ollollu cyuollo ul
ollollu cyuollo ullonho ylo ohou llo c
lu cyuollo ullonho ylo ohou llo ellh
lo ohou llo ellho ollollu cyuollo ul

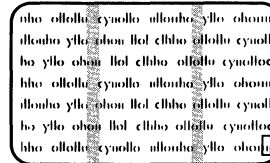

PAGE 1

aho ollolh cyuollo ullonho ylo ohonu
ullonho ylo ohou llo ellho ollollu cyuoll
ho ylo ohou llo ellho ollollu cyuollolc
lho ollolh cyuollo ullonho ylo ohonu
ullonho ylo ohou llo ellho ollollu cyuoll
ho ylo ohou llo ellho ollollu cyuollolc
lho ollolh cyuollo ullonho ylo ohonu

lu cyuollo ullonho ylo ohou llo ellh
lo ohou llo ellho ollollu cyuollo ul
ollollu cyuollo ullonho ylo ohou llo c
lu cyuollo ullonho ylo ohou llo ellh
lo ohou llo ellho ollollu cyuollo ul
ollollu cyuollo ullonho ylo ohou llo c
lu cyuollo ullonho ylo ohou llo ellh

PAGE 2

3. Protect mode is discussed in Chapter 4.

Table 2-6
Continued

Field Name	Possible Values	Description
ATAB	ON	If the cursor is on the first tab stop on a page's first line and memory contains more than one page, the status of autopage mode and the page number on which the cursor is located determines where cursor goes when the terminal receives a back tab code. If autopage mode is on, memory contains over one page, and the cursor is on the first tab stop on line one of page two or more, the display flips to the previous page and the cursor moves to the last tab stop on the last line.

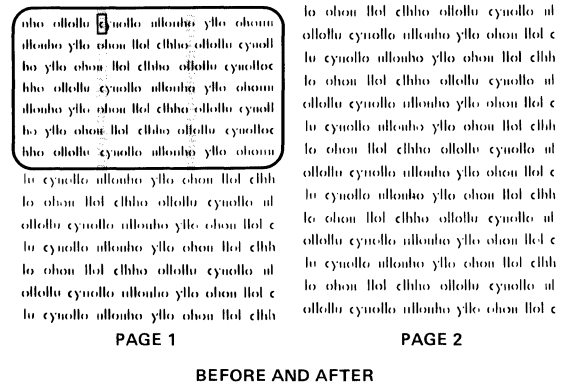

If the cursor is on the first page, it does not move.

Changing the Status Line

NOTE! *Although you can change the terminal's status line at any time, wait until any data transmission in progress is finished.*

1. Press SHIFT and SET UP at the same time to put the terminal in set up mode and display the status line.

STOP! *Unless you press the SHIFT key while pressing the SET UP key, you may stop all data transmission from the computer to the terminal.*
2. Look for the cursor to appear in the status line. Figure 2-6 shows the initial status line.
3. Press the T or t key to look at another value in the cursor's present field. Press it until you find the value you want to use. Table 2-7 lists the possible status line values.
4. Move the cursor to the next field you want to change, using the → or ← keys. Then press the t or T key again to select another value.
5. Press the ↑ and ↓ keys if you want to change the screen's brightness.
6. Press SHIFT and SET UP together when you want to leave set up mode and return the cursor to the main part of the screen.

Figure 2-6
Initial Status Line

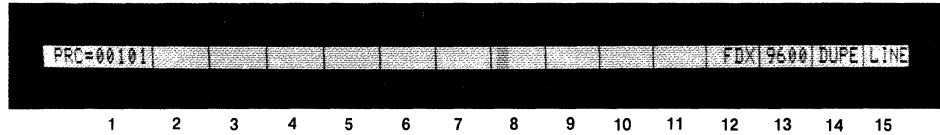

Table 2-7
Status Line Values

No.	Values	Description
1	P RR CC	Visible cursor's current position: P = Page of memory R = Row (line) C = Column
2	XXXX/blank	Handshaking status: CBSY = Computer busy (computer has sent X-Off to terminal) ¹ CTS = Voltage on Clear to Send line has dropped ² DSR = Voltage on Data Set Ready line has dropped ³ DCD = Voltage on Data Carrier Detect line has dropped ⁴
3	TBSY/blank	Terminal busy ⁵
4	PBSY/blank	Printer busy ⁶
5	XXXX/blank	Print type: PAGE = Page print TRSP = Buffered transparent print COPY = Buffered copy (extension) print BDIR = Bidirectional port communication Blank = All print types off
6	KLOK/blank	Keyboard locked/unlocked
7	SEND/blank	Sending/not sending a block of data
8	MONT/blank	Monitor mode on/off
9	PROT/blank	Protect mode on/off

1. If the computer sends X-Off to the terminal, the terminal stops sending data to the computer and displays CBSY in the status line. When the terminal receives X-On from the computer, it sends data to the computer again.
2. If the voltage drops on pin 5 of the computer interface line (P3), the terminal stops sending data to the computer. When the terminal's output buffer becomes full, the terminal locks up and the status line displays CTS. When the line voltage rises, the terminal sends the buffer's contents to the computer.
3. If the voltage drops on pin 6 of computer interface line (P3), terminal stops sending data to computer. When the terminal's output buffer becomes full, the terminal locks up and status line displays DSR. When voltage on the line rises, the terminal sends the buffer's contents to the computer.
4. When voltage drops on pin 8 of the computer interface line (P3), terminal receives no more data from the computer and displays DCD on the status line. When the voltage rises, characters sent by the computer are finally received.
5. Indicates the terminal's 256-character receive buffer (containing data received through the computer port) has room for fewer than 32 characters. This causes the terminal to send X-Off to the computer or lower the voltage on its DTR line, telling the computer to stop sending data.
6. Indicates the terminal received X-Off from the printer or voltage dropped on the DTR line.

Table 2-7
Continued

No.	Values	Description
10	W.P./blank	Write protect mode on/off
11	SMTH/blank	Smooth/normal (jump) scroll
12	FDX/BLK/HDX	Full duplex/block mode/half duplex
13	XXXXX	Computer port's baud rate 150 300 1200 1800 2400 4800 9600 19200
14	DUPE/LOCE	Duplex/local edit key mode
15	PAGE/LINE	Page/line edit mode

Reconfiguration Summary

Up to now, we have described how to change the terminal using the set up mode. You can also change (i.e., reset) the terminal by sending escape sequences to the terminal from the computer or keyboard or by pressing certain keys, as described in Table 2-8.

Table 2-8
Summary of Reset Methods

Method	Clears Screen?	Changes Status Line?	Function
CTRL shifted BREAK	No	Yes	Performs partial reset. Refreshes the status line with nonvolatile memory values (including latest set up line values, reprogrammed function and editing keys, and reprogrammed answerback code). Also turns off no scroll, print, write protect, and protect modes.
CTRL BREAK	No	No	May break communication with the computer by bringing the transmit data line to a space condition for 250 milliseconds and lowering voltage on the DTR line.
CTRL RESET	Yes	Yes	Performs a hardware reset. Refreshes the status line with nonvolatile memory values (including latest set up line values, reprogrammed function and editing keys, and reprogrammed answerback code). Same as sending ESC ~ 1 from the computer or turning power off and back on. Any common status and set up line values now match.
BREAK	No	No	Has no effect.

**Table 2-8
Continued**

Method	Clears Screen?	Changes Status Line?	Function
ESC ~1	Yes	Yes	Performs a software reset. Refreshes the status line with nonvolatile memory values (including latest set up line values, reprogrammed function and editing keys, and reprogrammed answerback code). Has same effect as pressing CTRL RESET on the keyboard or turning power off and back on.
ESC ~0	Yes	Yes	Resets software to factory values. Returns nonvolatile memory to factory values. STOP! <i>This sequence permanently destroys any reprogrammed values previously loaded into the nonvolatile memory.</i>
ESC } (code)	No	Yes	Changes set up values in nonvolatile memory and the displayed set up line values.
ESC !nn (code)	No	No	Only changes the function keys' values.
ESC ^ 1 (codes)	No	No	Only changes the answerback code.
ESC 0 n (3 bytes)	No	No	Only changes the value of one editing key.
ESC] n (60 bytes)	No	No	Only changes all shifted or unshifted editing keys.

Summary of Set Up Mode Procedures

Table 2-9 summarizes how you can change the terminal's operating parameters.

**Table 2-9
Summary of Set Up Mode Controls**

Function	Key
Enter set up mode, display status line on 25th line, and put cursor in status line	SET UP (shifted NO SCROLL)
See another value	t (or T)
Move cursor to another field in status or set up line	← or →
Replace status line with first set up line	n (or N)
Display next set up line	n (or N)
Display previous line	l (or L)
Increase contrast	↑
Decrease contrast	↓
Leave set up mode; return cursor to upper part of screen	SET UP (shifted NO SCROLL)

3. Operator Controls

Introduction

This chapter tells you how to control the terminal from the keyboard. It includes:

- The function of each key and the code it sends to the computer
- How to control communication between the terminal and computer and printer
- How to edit data
- How to send information to the computer in block mode
- How to print

The Keyboard

The keyboard is divided into two areas: the main keypad and an accounting keypad. Some keys are duplicated in both areas (for example, the keyboard has two TAB keys).

This chapter describes the default key functions. Since all editing keys [HOME, ↑, ←, ↓, →, TAB (both), BACK TAB, CLEAR SPACE, PRINT, CHAR INSERT, CHAR DELETE, LINE INSERT, LINE DELETE, LINE ERASE, PAGE ERASE, PAGE, SEND, CE, ENTER] can be reprogrammed, their effect may have been changed after the terminal was received.

NOTE! In the tables describing the keys, if the shifted name of a key is different from the unshifted name (e.g., SET UP/NO SCROLL), each name is entered separately. For example, the table lists SET UP, not "Shifted NO SCROLL."

Character Keys

The unshaded keys in Figure 3-1 are the **character keys**. They include all alphabetic characters (a through z), numbers (0 through 9), punctuation marks, and mathematical symbols.

NOTE! These keys repeat when pressed for more than one-half second.

Figure 3-1
Character Keys

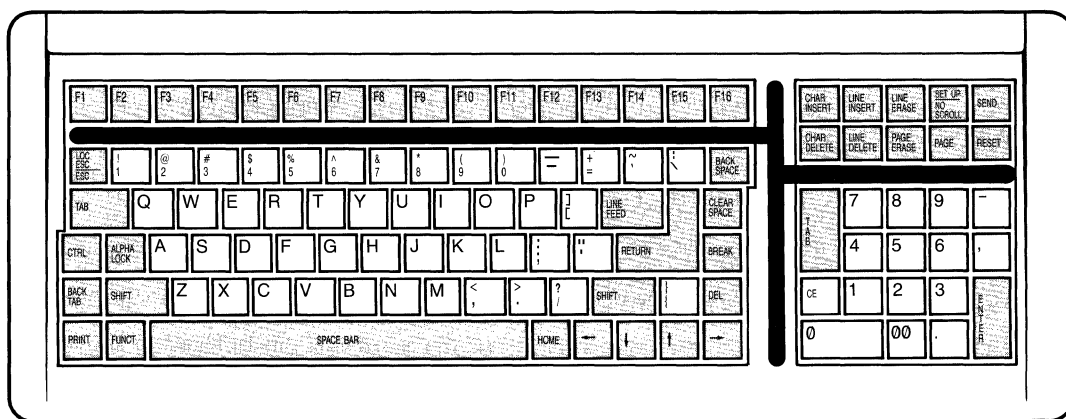

Special Keys

Table 3-1 summarizes the function of the unshaded keys in Figure 3-2. These keys are unique: they have no effect on the terminal and send no code to the computer unless you press them with another key. Unless noted, they also repeat when held down more than one-half second.

The modes controlling the terminal's operation (i.e., set up, protect, autopage, autotab, autowrap, etc.) can affect many keys. The next chapter discusses modes in more detail.

Figure 3-2
Special Keys Requiring Another Key

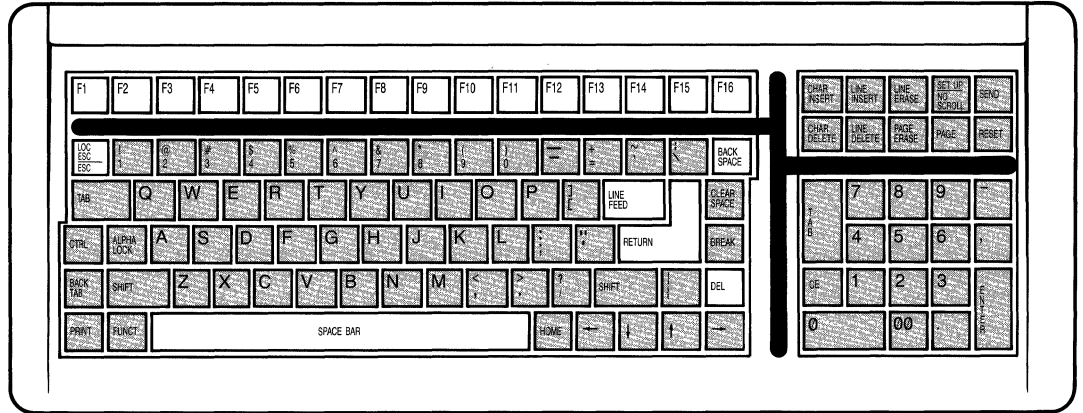

Table 3-1
Special Key Functions

Key Name	Effect
ALPHA LOCK	Causes an alphabetic key to send code for its uppercase character. Press once to lock; press again to release. Has no effect when used alone.
BREAK	Has no effect when pressed by itself. Causes other keys to send a different code.
CTRL (CONTROL)	Pressing CTRL with another key generates a control code that is normally not displayed. Control codes cause the terminal and/or computer program to take special action. When the CTRL key is pressed with an alphanumeric or some symbol keys, the character transmitted is changed. NOTE! Hold the CTRL key down while pressing the other key. CTRL alone has no effect.
FUNCT	Pressing FUNCT with another key transmits an SOH character, the next key's code, and a CR character. Has no effect by itself. Does not repeat.
SHIFT	Selects upper character shown on key, changes operation of many special keys, and capitalizes alphabetic characters. Unless pressed simultaneously with another key, has no effect.

The special keys within the second group, shown in Figure 3-3 and described in Table 3-2, function much like the alphanumeric keys shown in Figure 3-1. Editing modes do not affect these keys. Unless noted, they repeat when held down more than half a second.

NOTE! Refer to Chapters 2 and 4 for a description of the modes mentioned in this section.

Figure 3-3
Alphanumeric-Type Special Keys

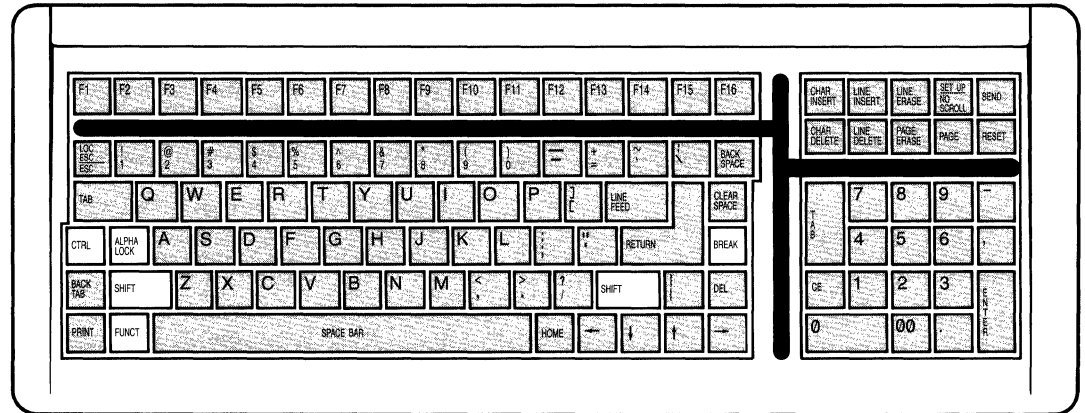

Table 3-2
Alphanumeric-Type Special Key Functions

Key Name	Effect
BACK SPACE	Moves the cursor left one character. If autopage mode is on when the cursor reaches the beginning of the page, flips the display to the previous page. Not affected by autowrap mode. Same as ← key.
DEL (DELETE)	Does not cause the terminal to perform or display anything when it receives this code. In monitor mode, displays DEL character. [Sends a DEL code (7F hex) to the computer.]
ESC (ESCAPE)	Sends the escape code to the computer (i.e., momentarily leaving the application program) so a special feature or function can be used. The ESC key introduces an escape sequence. Does not repeat. NOTE! <i>Press and release the ESC key before pressing the next key.</i>
F1 through F16	Each function key sends a reprogrammable three-code sequence capable of initiating a special computer program subroutine so the terminal displays or performs a special function. Does not repeat.
Shifted F1 through F16	Same as F1 through F16 but enables F17 through F32. Does not repeat.
LINE FEED	Moves the cursor down one line within the current column. Affected by protect and autopage modes.
Shifted LINE FEED	Same as LINE FEED.
LOC ESC (Shifted ESC)	Allows the next character(s) in an escape sequence to change only the terminal (i.e., does not send it to the computer). Does not repeat. NOTE! <i>To change only the terminal, press LOC ESC instead of ESC before entering the desired escape sequence on the keyboard.</i>

**Table 3-2
Continued**

Key Name	Effect
NO SCROLL	Press once to stop the display of incoming data on the screen (i.e., stop screen updating); press again to allow the display to continue. Does not repeat. If the terminal's receive buffer fills up while screen updating is disabled, the sends X-Off to the computer or lowers the level of the DTR line, stopping data transmission from the computer. When updating is reenabled, buffer empties, X-On is sent or voltage on DTR line is raised, and data transmission from the computer resumes.
RETURN	Sends a carriage return code to the computer. If the entire current line is protected, moves the cursor to the next unprotected position on the page. Does not repeat.
SET UP (Shifted NO SCROLL)	When pressed once, turns on set up mode and displays the status line. Displayed data is not lost. When pressed again, returns the cursor to the screen display. Does not repeat.
Space Bar	Sends a space character to the screen and the computer.

Editing mode affects all keys shown in Figure 3-4. Unless noted, each repeats when held down more than half a second. Table 3-3 describes the function of these special keys.

NOTE! Refer to Chapters 2 and 4 for a description of the modes mentioned in this section.

**Figure 3-4
Special Keys Affected by Editing Mode**

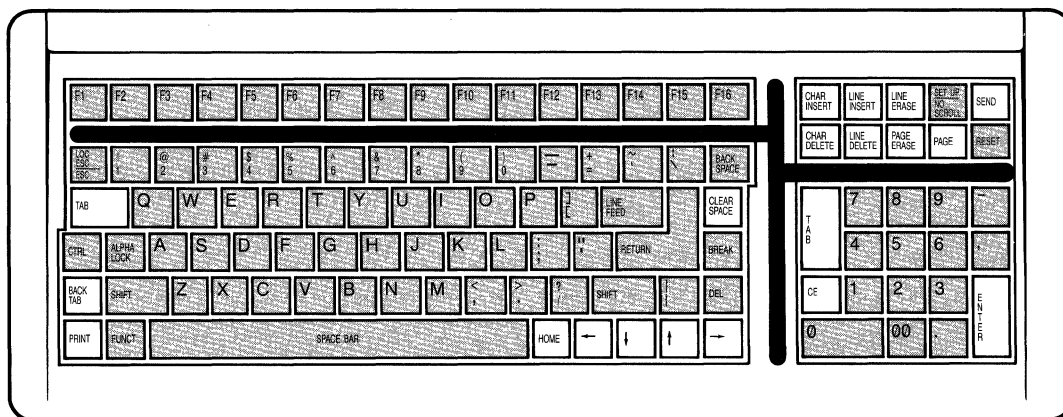

Table 3-3
Function of Special Keys Affected by Editing Mode

Key Name	Effect
BACK TAB	Returns cursor to previous typewriter tab stop (protect mode off) or to the start of current or previous unprotected field (i.e., field tab stop with protect mode on).
Shifted BACK TAB	Same as BACK TAB.
CE (CLEAR ENTRY)	Replaces all data on the current page with space characters. With protect mode off, clears data between typewriter tab stops and moves the cursor back to the beginning of the current field. Clears the entire line if it has no tab stops. With protect mode on, clears all data in the cursor's unprotected field. Does not repeat.
Shifted CE (CLEAR ENTRY)	Same as unshifted CE.
CHAR DELETE	Deletes the cursor character and shifts all succeeding characters one position to the left until they reach the previous write-protected field. Adds a space character at the end of the shifted text.
Shifted CHAR DELETE	Same as CHAR DELETE.
CHAR INSERT	Adds a space character at the cursor position, shifting all succeeding characters right one position. All characters shifted past 80th column are lost unless page edit mode is on. If page edit and autowrap modes are on, the whole page can shift until the shifted character encounters a write-protected position.
Shifted CHAR INSERT	Same as CHAR INSERT.
CLEAR SPACE	Replaces all unprotected characters on the page with space characters in the current visual attribute.
Shifted CLEAR SPACE	Replaces all unprotected data with null characters. Resets visual attribute and turns off protect mode.
←	Moves cursor left one character. Can wrap the cursor around to the previous line, regardless of autowrap mode's status.
Shifted ←	Same as unshifted ←.
↑	Moves the cursor up one line within the same column until it reaches a write-protected position (where it stops). Stops at the top line or first write-protected position. Moves cursor only within current page, regardless of autopage mode.
Shifted ↑	Reverse line feed. Moves the cursor up to the previous line within the same column. Once it reaches the page's first line, data scrolls down one line. Data on the page's last line is lost if autopage and protect modes are off. If autopage is off and protect mode is on, has no effect. If autopage is on, display flips to previous page and the cursor moves to last line of new page. If the current page is the first page, code has no effect.
↓	Moves the cursor down one line within the same column. If the cursor is on the display's bottom line and the page has more than 24 lines, data moves up one line (top line is not lost). When the cursor is on the page's bottom line, nothing happens. The cursor moves only within the current page, regardless of autopage mode.

**Table 3-3
Continued**

Key Name	Effect
Shifted ↓	Same effect as LINE FEED key.
→	Moves the cursor right one position. Can wrap the cursor to the next line, regardless of autowrap mode's status.
Shifted →	Same as unshifted →.
ENTER	Sends a carriage return code to the computer, regardless of how you configure RETURN key in set up line. Affected by local/duplex edit modes. If the entire current line is protected, moves the cursor to next unprotected position on page.
Shifted ENTER	Same as unshifted ENTER. Does not repeat.
HOME	Moves the cursor to the current page's first unprotected character position (called home position and usually column one of line one). Transmits ASCII RS character. Does not repeat.
LINE DELETE	Removes the current line and shifts lines below it up one line. Fills the last line of the page or scrolling region with a line of space characters in the current visual attribute. Ignored if protect mode is on.
Shifted LINE DELETE	Same as unshifted LINE DELETE.
LINE ERASE	Replaces data from cursor to end of line with space characters. With protect mode on, the effect is limited to current field.
Shifted LINE ERASE	Replaces data from cursor to end of line with null characters. With protect mode on, its effect is limited to current field.
LINE INSERT	Adds a line of space characters (with current visual attribute) on the cursor line. Data below that line shifts down one line. If the cursor is on the page's last line when terminal receives this code, that line is lost. Has no effect when protect mode is on.
Shifted LINE INSERT	Same as unshifted LINE INSERT.
PAGE	Shows the next page with the cursor on its previous position there. However, if logical attribute mode is on, the cursor is on the first unprotected position. Does not repeat.
Shifted PAGE	Shows the previous page with the cursor on its previous position there. However, if logical attribute mode is on, the cursor is on the first unprotected position. Does not repeat.
PAGE ERASE	Replaces unprotected data between the cursor and the end of the page with space characters. Has no effect when write protect or protect modes are on. Does not repeat.
Shifted PAGE ERASE	Replaces unprotected data between the cursor and the end of the page with null characters. Has no effect while write protect or protect modes are on. Does not repeat.
PRINT	Prints everything on the page between home and cursor positions. Replaces special graphics and write-protected characters with space characters. Sends carriage return, line feed, and null characters to printer after each line. Does not repeat.

Table 3-3
Continued

Key Name	Effect
Shifted PRINT	Prints everything between home and cursor positions on the current page. Replaces special graphics and write-protected characters with space characters. Pages are unformatted (unless printer does it automatically) because carriage return, line feed, and null characters are not sent to printer after each line. Does not repeat.
SEND	Sends all data between first column position and cursor to computer. Does not repeat.
Shifted SEND	Sends all data between home and cursor positions to the computer. Does not repeat.
TAB	If protect mode is off, moves the cursor forward to the next typewriter tab stop. If protect mode is on, moves it to the next field tab stop (start of next unprotected field).
Shifted TAB	Same as TAB.

Keys highlighted in Figure 3-5 reset the terminal. Table 3-4 describes their effect. None of these keys has repeat action or any effect when pressed alone.

Figure 3-5
Terminal Reset Keys

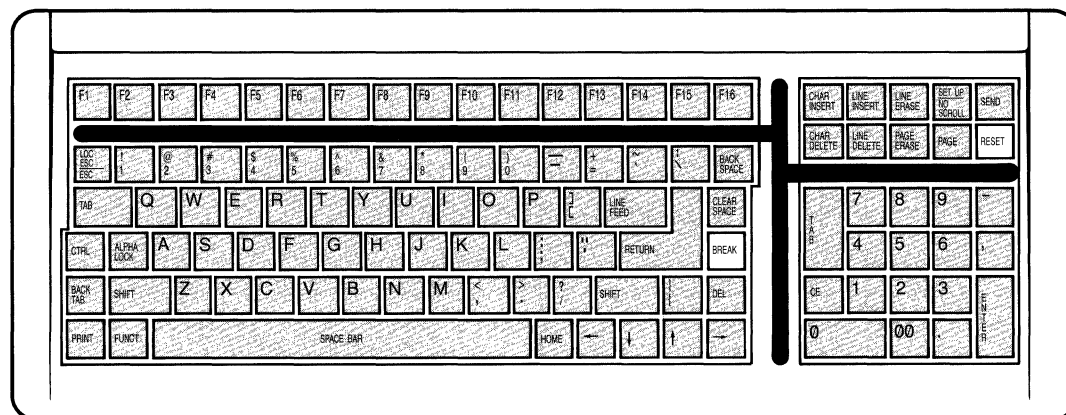

Table 3-4
Reset Keys

Key Name	Effect
CTRL BREAK	May break communication with computer by bringing transmit data line to space state for 250 milliseconds.
CTRL shifted BREAK	Refreshes the status line with nonvolatile memory values (including latest set up line values, reprogrammed function and editing keys, and reprogrammed answerback code). Turns off no scroll, print, write protect, and protect modes.
RESET	Has no effect when pressed alone.
CTRL RESET	Returns terminal to latest set up line configuration. (Same as turning power off and back on.) Does not repeat.
Shifted RESET	Has no effect when pressed alone.

The Cursor

The cursor is a contrasting rectangular block or underline (selected in the set up line) that indicates the position of the next entered character. The cursor can be invisible, steady, or blinking.

You can move the cursor with the ↑, ←, →, ↓, TAB, BACK TAB, or BACK SPACE keys (described in the previous section).

Editing

The special editing keys described in Table 3-3 make it easy to change data after you enter it. To remove data, you can either erase it, delete it, or clear it. You can also insert additional space characters.

Erasing replaces characters with space characters, starting at the cursor position and continuing through the end of the line or page (depending on whether line or page edit mode is on), as shown in Figure 3-6. Erasing does not move any data.

Figure 3-6
Erasing Data

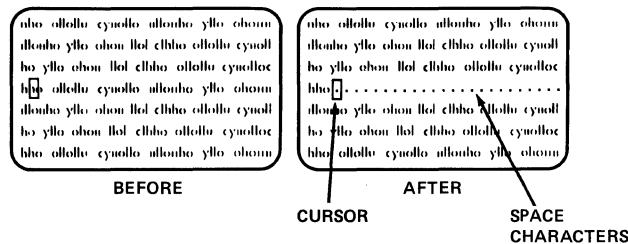

Deleting a character removes the character at the cursor position and pulls the next character back into that position. If you hold the CHAR DELETE key down, the amount of data that can flow backward depends on the edit boundary mode in effect (either line edit or page edit). See Figure 3-7.

Figure 3-7
Data Movement Caused by Deleting Text

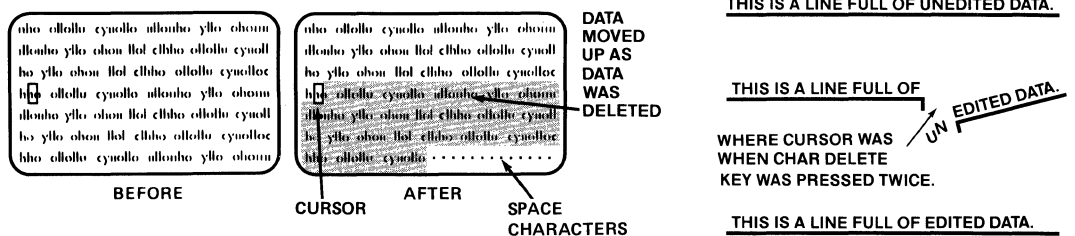

When you clear data, you replace all unprotected data on the current page with space characters. Unlike erasing, which starts at the cursor position and can be limited by the edit boundary modes, clearing is independent of the cursor's position and is unaffected by the current edit boundary mode.

Communication Modes

Communication modes determine when and where data goes after you enter it at the keyboard and how interaction with the computer takes place. You can change the current communication mode in the status or set up lines (Chapter 2). Communication between the terminal and the computer can be in any one of the following modes:

- Block
- Half duplex (conversational)
- Full duplex (conversational)

Figure 3-8 shows how data flows in each mode. Table 3-5 describes each communication mode.

Figure 3-8
Data Flow

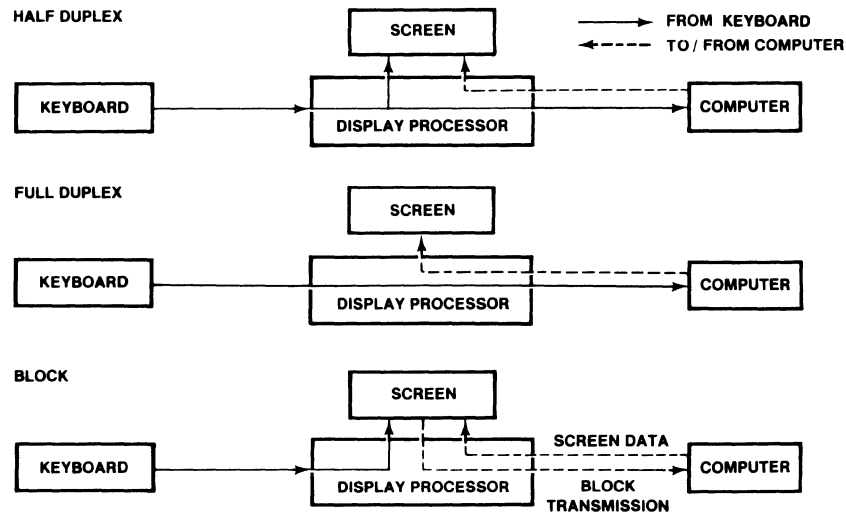

Table 3-5
Communication Modes

Name	Effect
Block	The terminal first sends data only to the screen so you can check and correct it if needed. You determine when the block of data is sent to the computer. Block mode allows you to make all corrections before sending data to the computer (with the SEND key or an escape sequence).
Half Duplex	The terminal sends keyboard entries to the screen and to the computer at the same time. Although it is a conversational mode, it does not permit the terminal to transmit and receive simultaneously.
Full Duplex	The terminal sends keyboard entries only to the computer. If the computer is programmed to act upon a code generated by a keyboard entry, it may echo the result back to the terminal. The terminal can transmit and receive simultaneously.

Sending Data to the Computer

If you enter data while the terminal is in block mode, it does not go to the computer until you send it. This lets you make additions or corrections first. When you finish editing, you can transmit it to the computer with the SEND key—if the terminal is in block mode. (If the terminal is not in block mode when you press SEND, the key merely sends the escape sequence to the computer.)

Once started, block mode transmits faster than the conversational modes because the terminal can transmit faster than you can enter data on the keyboard..

The unshifted SEND key sends all data on the cursor line, starting at the first column position and continuing through (i.e., including) the cursor position. See Figure 3-9.

Figure 3-9
Data Sent by Unshifted SEND Key

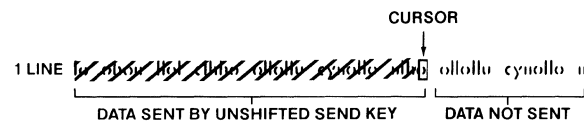

The shifted SEND key sends all data on the page, from the home position through (i.e., including) the cursor position. See Figure 3-10.

NOTE! You could also use any of the escape sequences described in Chapter 4.

Figure 3-10
Data Sent by Shifted SEND Key

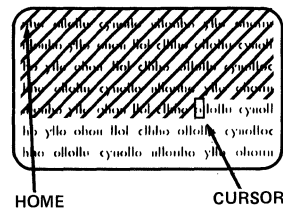

Printing

If you have a printer connected to the terminal, pressing the PRINT key prints the current page. This is called **page print**. How much is printed depends on whether you press the shifted or unshifted PRINT key. Refer to Table 3-6.

NOTE! If the PRINT key is to function as described while the terminal is in full duplex, the terminal must be in local edit mode or the computer must echo the escape sequence back.

Table 3-6
Printing Data from the Screen

Key	Sends to Printer
Unshifted PRINT	All characters (except graphics) between home and cursor positions. Includes any delimiters that format data. ¹ (Called formatted page print .)
Shifted PRINT	All characters (except graphics) between home and cursor positions. Since formatting delimiters (CR and LF) are not included, the appearance of the printed copy depends on whether or not the printer automatically adds delimiters. (Called unformatted page print .)

1. See the discussion of delimiters and formatted and unformatted printing in Chapter 4.

4. Programming Controls

Introduction

This chapter describes commands that both programmers and operators can use to control the terminal.

Using These Commands in Your Programs

Incorporating these commands in your computer programs lets you control the terminal remotely.

How you incorporate these commands depends on your programming language. The multitude of languages and syntaxes recognized by each language makes it impossible to show you specifically how to incorporate commands in each program. The terminal's response is based on the control code or escape sequence received, regardless of the format and syntax used by a programming language to send it to the terminal. If you need help with the proper syntax, refer to your programming language's documentation.

NOTE! *To receive a TeleVideo booklet describing how to incorporate terminal controls in a BASIC program, return the reader comment card from this manual with the appropriate box checked.*

Entering These Commands on the Keyboard for Local Display

If you only want to change data displayed on the screen and in the terminal's screen memory, press the LOC ESC key instead of ESC in the escape sequences in this chapter. The computer will not be aware of these commands or the changes caused by them unless you send the revised data to it.

You can also use the editing keys without sending anything to the computer while local edit mode (discussed later in this chapter) is on.

Figures

Many figures are included in this chapter to help you visualize the difference between similar commands. However, the amount of data contained within a page of memory or displayed on the screen is not shown to scale. Shaded areas denote protected fields, unless labeled otherwise. Slanted lines show how much data a send command can transmit to the computer. Dots indicate space characters.

Conventions

The modes and functions that can also be controlled in the status and set up lines are marked with the words **STATUS** and **SET UP** (printed even with the section title).

Monitor Mode

	STATUS
Monitor mode on	ESC U
Monitor mode off	ESC X

Program debugging is easier when you put the terminal in **monitor mode** so you can see the control and escape commands received by the terminal. In monitor mode, commands are displayed (Figure 4-1) but not acted upon.

NOTE! *If you precede a control character with an ESC character, you can display it without putting the terminal in monitor mode.*

Table D-1 in Appendix D shows how control characters appear in monitor mode. For example, the ASCII character SOH (entered as CTRL A in the program) appears on the screen during monitor mode as S_H. Escape sequences include an E_C for the ESC character. A null character appears as N_L.

Figure 4-1
Typical Monitor Mode Display

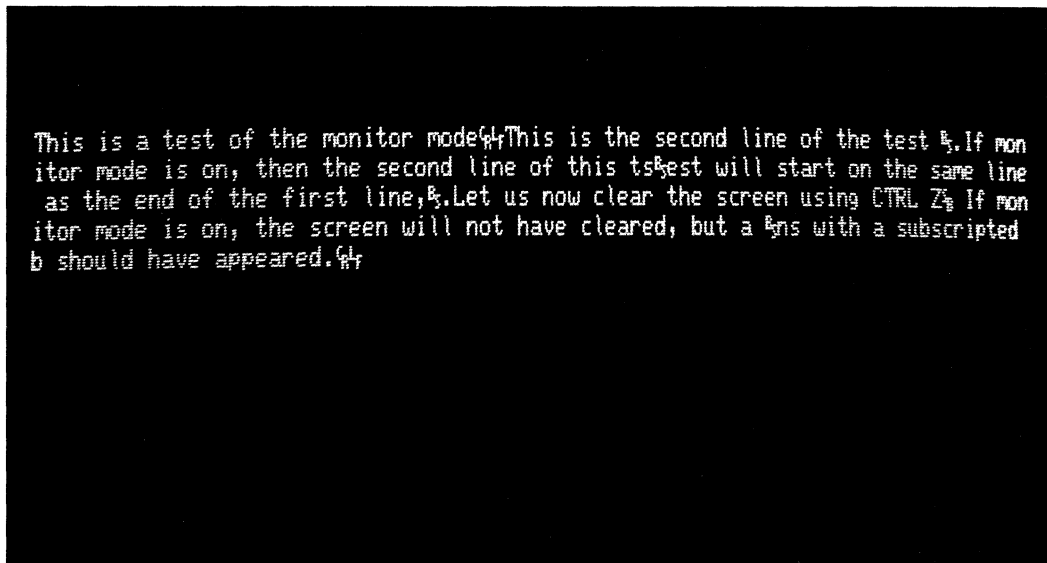

Resetting the Terminal

Reset the terminal's nonvolatile memory to factory default values	ESC ~0
Reset the terminal to set up/status line values	ESC ~1

You can reset the terminal to the factory default values or the set up/status line values. Both commands void any parameters previously changed by commands from the keyboard or computer.

Sending ESC ~0 restores the factory default values in the nonvolatile memory.

STOP! ESC ~0 erases any reprogramming previously loaded into the nonvolatile memory.

Sending ESC ~1 to the terminal is the same as pressing CTRL RESET on keyboard or turning the power off and back on. The nonvolatile memory (containing the most recent set up line values, reprogrammed function and editing keys, and reprogrammed answerback code) refreshes the status line.

Set Up Memory

Establish set up line values	ESC } (codes)
Report values from set up lines	ESC Z 2

where

(codes) contains 12 ASCII characters between ` (60 hex) and o (6F hex).

The lower order 4 bits of each character are loaded into the nonvolatile set up memory.

The set up memory's bit map is shown in Tables 4-1 through 4-4.

Table 4-1
Set Up Memory Bit Map

Char-acter No.	Value	Bit 3 Name	Bit 2 Name	Bit 1 Name	Bit 0 Name	
		Communication Mode			Edit Mode	Edit Key
1	0	FDX	—	Line	DUPE	
	1	HDX	BLK	Page	LOCE	
2	0	Autotab Off	Unused	Scroll Type Normal	Scroll Rate 6 lines	
	1	On		Smooth	12 lines	
3	0	Protocol X-On/Off	RETURN key CR	↓key CTRL V	Must be 0	
	1	DTR	CR and LF	CTRL J		
		Character Set			Time Out	
4	0	See Table 4-2			Off	
	1				On	
5	0	Autopage Off	Autowrap Off	Status line Undisplayed	Keyclick Off	
	1	On	On	Displayed	On	
		Cursor Attribute				
6	0	Must be 0	Displayed	Block	Blinking	
	1		Invisible	Underline	Steady	
		Computer Port Baud Rate				
7	0	Must be 0	See Table 4-3			
	1					
		Stop Bits	Computer Port Parity Bit		Word Length	
8	0	1	Send	Even	7 bits	
	1	2	No	Odd	8 bits	
		Printer Port				
9	0	Must be 0	See Table 4-3			
	1					
		Stop Bits	Printer Port Parity Bit		Word Length	
10	0	1	Send	Even	7 bits	
	1	2	No	Odd	8 bits	
		Refresh	Background		Screen Contrast	
11	0	60 Hz	Must be 0	Dark	See Table 4-4	
	1	50 Hz		Light		
		Screen Contrast				
12	0	See Table 4-4				
	1					

**Table 4-2
Character Set Bit Map**

Language	Bit No.		
	3	2	1
US ASCII	0	0	0
UK	0	0	1
French	0	1	0
German	0	1	1
Spanish	1	0	0
Finnish/Swedish	1	0	1
Danish/Norwegian	1	1	0
Portuguese	1	1	1

**Table 4-3
Baud Rate Bit Map**

Baud Rate	Bit No.		
	2	1	0
150	0	0	0
300	0	0	1
1200	0	1	0
1800	0	1	1
2400	1	0	0
4800	1	0	1
9600	1	1	0
19200	1	1	1

**Table 4-4
Contrast**

Level	Bit No.				
	4	3	2	1	0
Dimmest	0	0	0	0	0
	0	0	0	0	1
Default	1	0	0	0	0
Brightest	1	1	1	1	1

The computer can establish the set up line values in the terminal's memory and read the current values of the set up lines. When the terminal receives the command to set the values, it changes the bit map in memory as well as the terminal's current configuration.

When the computer reads the values, it receives 12 characters. Refer to Tables 4-1 through 4-4 here (or Tables E-1 through E-4 in Appendix E) to interpret the setting represented by these characters.

For example, suppose the computer receives the following 12 ASCII characters:

rr~p{qwsyssx

This sequence is explained in Table 4-5.

Table 4-5
Example Set Up Memory Sequence

Character No.	ASCII Character ¹	Lower Four Bits		Effect
		No.	Value	
1	r	3	0	Full duplex
		2	0	Block off
		1	1	Page edit
		0	0	Duplex edit keys
2	r	3	0	Autotab off
		2	0	No effect
		1	1	Smooth scroll
		0	0	6 lines/second
3	~	3	1	DTR
		2	1	CR and LF
		1	1	CTRL J
		0	0	Required value
4	p	3	0	US ASCII
		2	0	US ASCII
		1	0	US ASCII
		0	0	Time out off
5	{	3	1	Autopage on
		2	0	Autowrap off
		1	1	Status line displayed
		0	1	Keyclick on
6	q	3	0	Required value
		2	0	Displayed cursor
		1	0	Block cursor
		0	1	Steady cursor
7	w	3	0	Required value
		2	1	Computer port 19.2k baud
		1	1	Computer port 19.2k baud
		0	1	Computer port 19.2k baud
8	s	3	0	Computer port uses 1 stop bit
		2	0	Computer port sends parity bit
		1	1	Computer port's parity bit is even
		0	1	Computer port's word length is 8 bits
9	w	3	0	Required value
		2	1	Printer port 9600 baud
		1	1	Printer port 9600 baud
		0	1	Printer port 9600 baud
10	s	3	0	Printer port uses 1 stop bit
		2	0	Printer port sends parity bit
		1	1	Printer port's parity bit is even
		0	1	Printer port's word length is 8 bits
11	s	3	0	Refresh screen at 60 Hz
		2	0	Required value
		1	1	Light background
		0	1	Brightest contrast
12	x	3	1	Default contrast
		2	0	Default contrast
		1	0	Default contrast
		0	0	Default contrast

1. As shown in the ASCII Chart in Appendix C, any of eight ASCII characters share the same values in their lower four bits. For instance, the value of the lower four bits are the same for NUL, DLE, SP, 0, @, P, -, and p. In this example, the ASCII characters are taken from the table's far right column.

Send Message/Status Line Send message or status line to computer ESC Z n

where

n defines the type of line to be sent.

n Value	Sends
0	80-byte message line
1	80-byte status line

Send Terminal Configurations Send current or nonvolatile memory configurations to computer ESC p n

where

n defines the type of configuration to be sent.

n Value	Sends
0	Current terminal configurations (12 bytes)
1	Nonvolatile set up memory (12 bytes)

Locking/Unlocking the Keyboard Lock (disable) the keyboard STATUS
Unlock (enable) the keyboard ESC #
ESC "

You can prevent the keyboard from sending any codes. This is often called **locking** the keyboard; however, since the keys can still be depressed, that term is somewhat of a misnomer. A more precise term is **disabling** the keyboard. You might use this feature to prevent data entry while the program builds a special form.

To unlock the keyboard, either press the CTRL RESET keys, or send ESC " from the computer, or turn the power off and back on again. (Pressing CTRL RESET resets the terminal, unlocks the keyboard, and clears the screen of all data.)

Cursor Style SET UP

No displayed cursor	ESC . 0
Blinking block cursor	ESC . 1
Steady block cursor	ESC . 2
Blinking underline cursor	ESC . 3
Steady underline cursor	ESC . 4

You have a choice of five cursor styles. The style you select with one of these commands remains in effect until you change it with another command, change the set up line, or turn off the terminal.

Keyclick and Bell SET UP

Keyclick on	ESC < 1
Keyclick off	ESC < 0
Ring bell	CTRL G

Your program can ring the terminal's bell and control whether the keys click when pressed. The bell rings automatically whenever the terminal receives an illegal command (such as a line insert command while protect mode is on).

Display Controls

These commands let you change the appearance and contents of the screen display. You can control what is displayed on the bottom line and the color (light or dark) of the characters on the screen.

Contents of the 25th Line

The screen displays up to 24 lines of data. The 25th line can display three types of lines:

Name	Description
Set up line	Any of five set up lines
Status line	Status of terminal's current operating parameters
Message line	A message to the operator

Table 4-6 lists the attributes that can be included in the 25th line.

Table 4-6
Attributes of the 25th Line

Attribute/ Characteristic	25th Line	
	Message Line	Status and Set Up Lines
Screen background	Reverse of other lines	Reverse of other lines
Visual attributes	Can be controlled	Can not be controlled
Character sets	Can use any	Always US ASCII

Controlling the 25th Line's Display

Define contents of 25th line

SET UP
ESC s n

where

n defines the type of display.

n Value	Effect
0	No display (blank)
1	Message line
2	Status line

The Status Line

The status line (described in Chapter 2) summarizes some of the current terminal parameters and displays busy messages.

The Message Line

Program message line

ESC f (text) CTRL Y

The 25th line can also display a special message to the operator from the computer program. This is the **message line**.

Appearance—To vary the appearance of the message line, include any of the visual attributes (described later in this chapter). For instance, the line might include both dark characters on a light background and light characters on a dark background, with some parts also blinking.

Clearing the Message Line—The message line is cleared whenever the terminal's power is turned off.

Programming the Message Line—Until you program a message for the message line, it is blank.

1. Display the message line (if you want to see the message as you enter it) with the command

ESC s 1

2. Enter the command

ESC f

3. Enter a visual attribute command for the first character position if desired. Default is steady characters in reverse video.

4. Enter up to 80 characters of text. If you displayed the message line before entering the message, the message appears on the message line as you enter it. However, the cursor does not enter the message line during the data entry.

5. You can also include any of the 15 visual attributes (described in a later section). (Since visual attributes do not occupy a space, do not count them as part of the 80 text characters.)

6. Include the command

CTRL P

when the next command is a CTRL Y or CTRL P that you want to be displayed in the message line.

7. Enter

CTRL Y

to end the message.

Screen Display

Turn screen on	ESC n 0
Turn screen off	ESC n 1

These commands determine whether or not the screen can display data.

Screen Attributes

Light background with dark characters	ESC b
Dark background with light characters	ESC d

The screen's background is either light with dark characters or dark with light characters.

Remember that you can also change the background in the set up line. The effect of the screen background command depends on the background chosen with the set up line. If the terminal receives a command that is the same as the current background, no change occurs.

Visual Attributes

Define visual attribute(s)

ESC G n

where

n defines the visual attribute and its intensity.

n Value		Visual Attribute
Full Intensity	Half Intensity	
0	sp	Normal (default) video
1	!	Invisible normal video
2	''	Blink
3	#	Invisible blink
4	\$	Reverse current background
5	%	Invisible reverse
6	&	Reverse and blink
7	'	Invisible reverse and blink
8	(Underline
9)	Invisible underline
:	*	Underline and blink
;	+	Invisible underline and blink
<	,	Reverse and underline
=	-	Invisible reverse and underline
>	.	Reverse and underline and blink
?	/	Invisible reverse and underline and blink

Visual attributes:

Do not occupy a character position (you can also enter a character in that position)

Affect all subsequent characters until you change the attribute

To set a visual attribute, place the cursor where you want the attribute to start; then enter the appropriate escape sequence.

Changing how characters appear can dramatically change the appearance of the screen. Remember this feature when you create forms.

The visual attributes incorporate these effects:

Name	Effect
Normal video	Restores background of screen to value in set up line (either dark or light).
Reverse video	Changes screen's background to reverse of current background. If screen background was dark with light characters, it is now light with dark characters.
Underline	Creates a solid line below character(s).
Blink	Causes character(s) to blink.
Invisible	Makes all subsequent data entered invisible (although cursor is still visible and data is transmitted to computer). Often used to enter a password, payroll, or other security-sensitive information.
Half intensity	Decreases the normal intensity by one half (on a character-by-character basis). All other visual attributes can include half intensity.

Block Attributes Define block of attributes ESC F w h

where

w = The width of the block in character positions, starting with the current cursor position and extending forward.

h = The height of the block in lines, starting with the current cursor line.

w and h are values from the cursor coordinate table in Appendix E.

NOTE! While protect mode is on, this command is ignored.

You can create blocks filled with the current visual attribute. If the blocks overlap, the last block entered hides those already entered. Figure 4-2 illustrates a display with three blocks of visual attributes. The block filled with horizontal lines was the last block entered.

Figure 4-2
Display with Three Blocks of Attributes

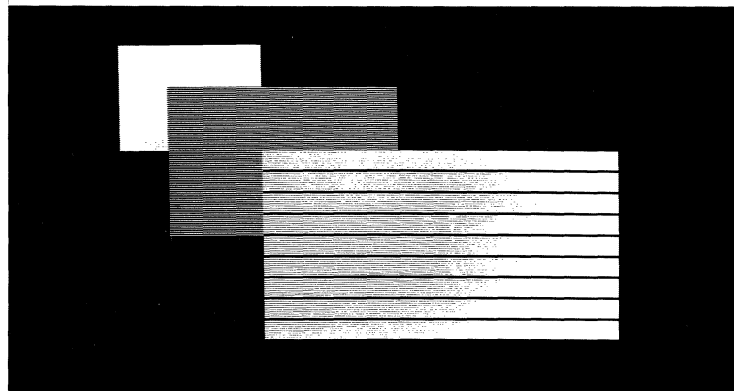

To fill an area with visual attributes:

1. Position the cursor on the upper left corner of the area to be defined.
2. Define the visual attribute for the area (ESC G n) if necessary.
3. Make sure protect mode is off.
4. Enter

ESC F w h

5. Repeat Steps 1 through 4 for each block.

NOTE! Block attributes are limited by the length of the page and the defined scrolling region. Although the block can extend beyond the display, only part of it may be visible. Entering values greater than the screen results in a block which ends at the right or bottom margin of the screen.

Block Graphics

Define block graphics area

ESC H w h

where

w = A value from the cursor coordinate table (Appendix E) representing the length in character positions of the horizontal line to be generated by this command. The line starts at the cursor and extends to the right.

h = A value from the cursor coordinate table (Appendix E) representing the height in character positions of the vertical line to be generated by this command. The line starts at the cursor and extends down.

The w and h values define the outside dimensions of the rectangle.

The status of special graphics mode is irrelevant.

You can outline one or more areas with horizontal and vertical lines. Figure 4-3 shows how the screen might appear with three overlapping blocks.

Figure 4-3
Display with Three Blocks of Graphics

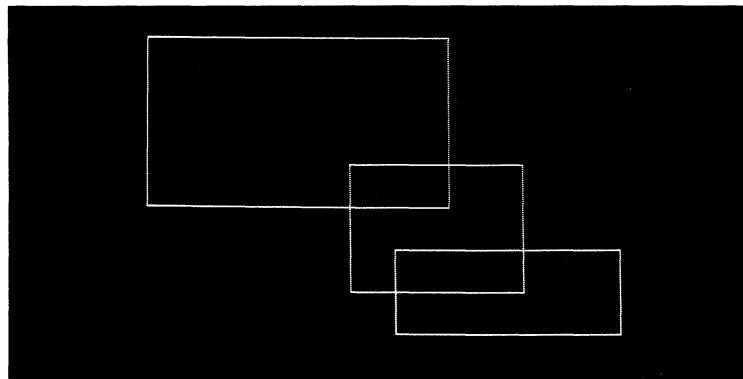

NOTE! Block graphics are limited by the length of the page and the defined scrolling region. If the block extends beyond the limits of the display, only part of it is visible. Entering values greater than the page results in a block that ends at the right or bottom margin. This command has no effect while protect mode is on.

To create a block graphics area:

1. Position the cursor where you want the top left corner before entering the sequence.

NOTE! Executing this sequence does not move the cursor.

2. Define the width and height of the area with

ESC H w h

where w defines the width in character positions and h is the height in lines.

Special Graphics Mode Special graphics mode on; alphanumeric mode off ESC \$
Special graphics mode off; alphanumeric mode on ESC %

You can incorporate 64 special graphics characters in your program. Figure 4-4 shows these characters and the keys that produce them. The terminal generates them only while it is in special graphics mode. You can protect special graphics characters as you would any other character.

**Figure 4-4
Special Graphics Characters**



Character Set Select character set ESC c n

where

n defines the next character set in which data will be displayed.

n Value	Character Set
0	US ASCII
1	UK
2	French
3	German
4	Spanish
5	Finnish/Swedish
6	Danish/Norwegian
7	Portuguese

This command allows you to mix displayed character sets. All data received by the terminal after it receives this sequence will be displayed in the character set specified by this sequence. The sequence does not change data already displayed.

Additional Screen Memory

Unless the terminal contains the chips for additional screen memory, the commands described in this section have no effect.

Configuring Memory

Define number of lines on each page ESC \ n

where

n is a value for the lines per page.

n Value	Lines per page	Number of Pages
1	24	4
2	48	2
3	96	1

STOP! When you execute this command, the terminal:

- Clears all pages of memory
- Fills all pages with space characters
- Displays page one with the cursor on the home position
- Redefines the scrolling region as the entire 24 lines

NOTE! The term *page* (i.e., document) refers to an amount of memory (ranging from 24 to 96 lines).

Not to be confused with the term **page**, **screen** refers to the face of the tube on which data appears. The **display** is the amount of data which can be viewed on the screen at one time—the viewable region.

Since the screen displays 24 lines at a time, the display you see on the screen may not contain the entire page. See Figure 4-5.

You can divide the terminal's total screen memory into one, two, or four pages (Figure 4-6). (Without additional memory, the single page contains 24 lines.)

Figure 4-5
Partial Page of Memory Displayed on the Screen

```

lo ohu flol elhu ollolu cyullo ul
ollolu cyullo ullouho ylo ohu flol c
lu cyullo ullouho ylo ohu flol elhu
lo ohu flol elhu ollolu cyullo ul
  
```

```

  hbo ollolu cyullo ullouho ylo ohu
  ullouho ylo ohu flol elhu ollolu cyull
  ho ylo ohu flol elhu ollolu cyulloac
  hbo ollolu cyullo ullouho ylo ohu
  ullouho ylo ohu flol elhu ollolu cyull
  ho ylo ohu flol elhu ollolu cyulloac
  hbo ollolu cyullo ullouho ylo ohu
  
```

```

lu cyullo ullouho ylo ohu flol elhu
lo ohu flol elhu ollolu cyullo ul
ollolu cyullo ullouho ylo ohu flol c
  
```

Figure 4-6
Dividing Memory into Pages

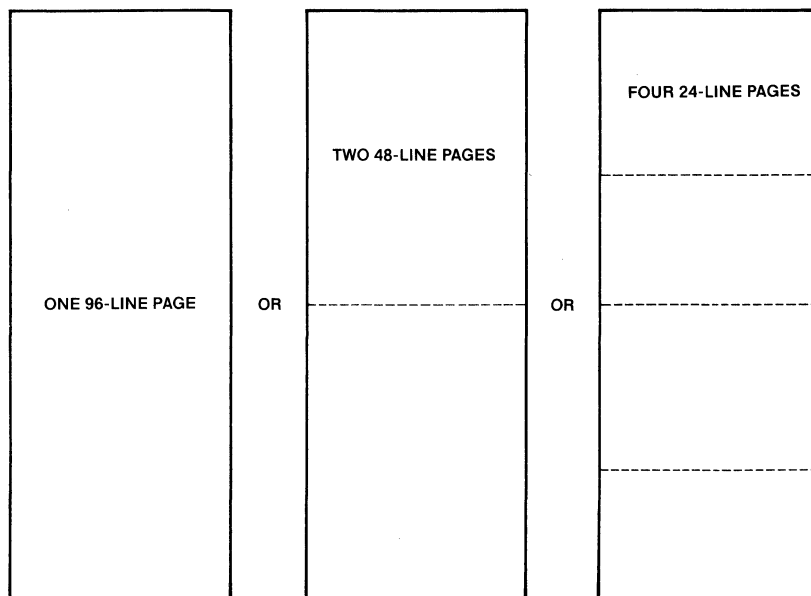

Autopage Mode

Autopage mode on
Autopage mode off

SET UP
ESC v 1
ESC v 0

Autopage mode determines whether the screen scrolls or flips to the next page when the terminal receives a code to move the cursor beyond the current page.

With autopage mode on, you can only scroll within the current page (if it contains more than 24 lines). Once the cursor reaches the page's boundary, a command to move the cursor further (with cursor right, cursor left, tab, back tab, or cursor addressing keys or commands) flips the display to the adjoining page (as shown in Figure 4-7). What happens is similar to turning the pages of a book. The whole screen changes at once, not just one line at a time.

NOTE! *You can not move the cursor into another page with the ↑ or ↓ keys or cursor up or down codes, regardless of the status of autopage mode.*

You can move the cursor to the first or last line of an adjoining page with a line feed or reverse line feed command, while the cursor remains in the same column.

Figure 4-7
Cursor Movement During Autopage Mode

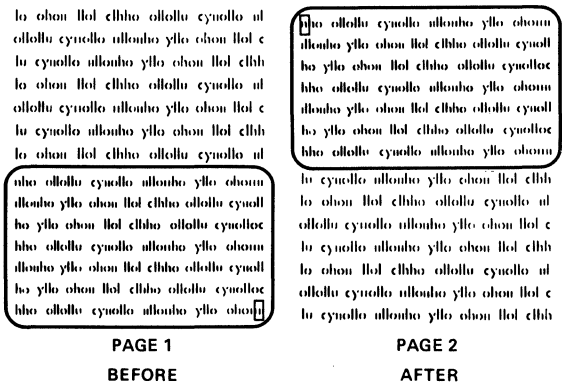

Moving to a Different Page

Move to the next page
Move to the previous page

ESC K
ESC J

When memory contains two or more pages, these commands let you move to an adjacent page, regardless of the autopage mode. If the entire adjacent page is write protected, this command turns off protect mode.

NOTE! *If the cursor is in a field requiring total or some data entry while the logical attribute mode is on, these commands are ignored. Move the cursor out of the field first.*

Remember, the screen displays only part of the page when the page contains 48 or 96 lines.

The cursor's position on the next page depends on whether you moved the cursor into it while autopage was on or whether you turned to that page with the next or previous page command. When you continue moving the cursor into another page, the cursor moves to the first unprotected position (either on the next line or in the same column). But advancing or returning to another page returns the cursor to its former position (if any) on that page, as shown in Figure 4-8.

Figure 4-8
Cursor Movement Between Adjacent Pages

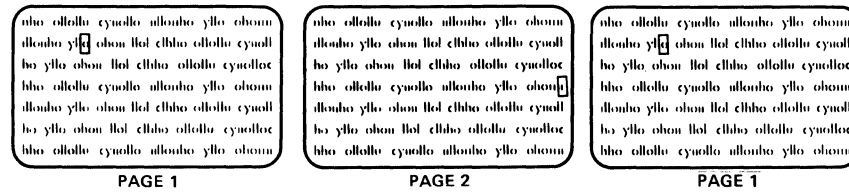

Scrolling

Smooth scroll mode on
Normal scroll mode on

SET UP/STATUS
ESC 8 1
ESC 8 0

The terminal's scrolling can be smooth or normal. Smooth scroll mode moves text at an even rate, regardless of how fast the terminal receives it. Normal scroll mode displays data as it is received. (Normal scroll is sometimes called **jump scroll** since the display is not regulated by the terminal.)

NOTE! Specify the scrolling rate of smooth scroll mode during set up mode.

Scrolling moves data up or down on the screen so you can view other parts of the current page.

Scrolling is similar to taking a movie of a movie screen. The movie camera corresponds to the terminal's screen and the movie screen that you are photographing is the terminal's page of memory. You can move the movie camera around to photograph different areas of the movie screen. However, if you move the movie camera too far, it also takes a picture of "nothing" (beyond the movie screen). But as long as you keep the camera focused on the movie screen, it photographs only the movie.

When the terminal screen moves (scrolls) within a page filled with data, the screen displays only data. However, if the screen scrolls into a memory area without data (empty memory space), a line of spaces appears on the terminal screen. Unlike taking a movie of a movie screen, once the terminal screen encounters a blank area of memory while scrolling, it remains blank when you scroll back the other way (until you enter more data to fill the area again). See Figure 4-9.

Figure 4-9
Scrolling Movement Within Page of Memory

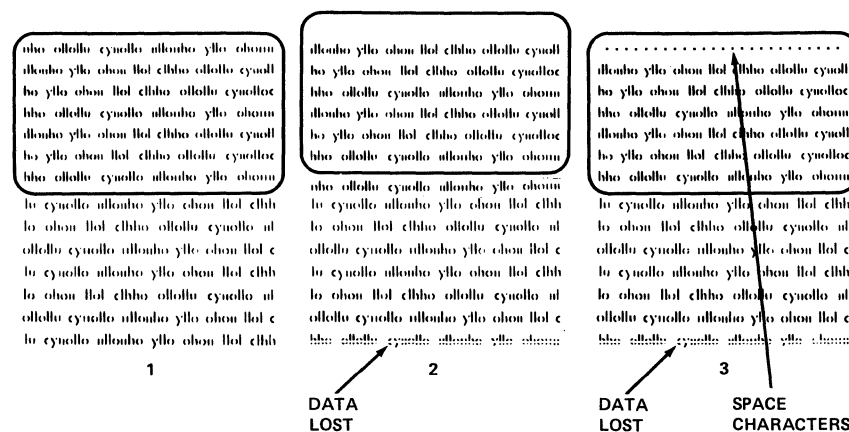

Defining a Scrolling Region

Define a scrolling region

ESC _ t b

where

t = A value from the cursor addressing table (Appendix E) for the first (top) line in the scrolling region

b = A value from the cursor addressing table (Appendix E) for the last (bottom) line in the scrolling region

To control the lines that can scroll, turn autopage off and define a scrolling region. Otherwise the entire screen can scroll.

Figure 4-10 shows line movement when the screen is scrolled up and then down within one page of memory.

NOTE! You can not change data outside the scrolling region. It remains fixed on the screen, although data within the scrolling region can move. Remember that changing the page length redefines the scrolling region as the whole screen.

Figure 4-10
Scrolling Movement Within a Scrolling Region

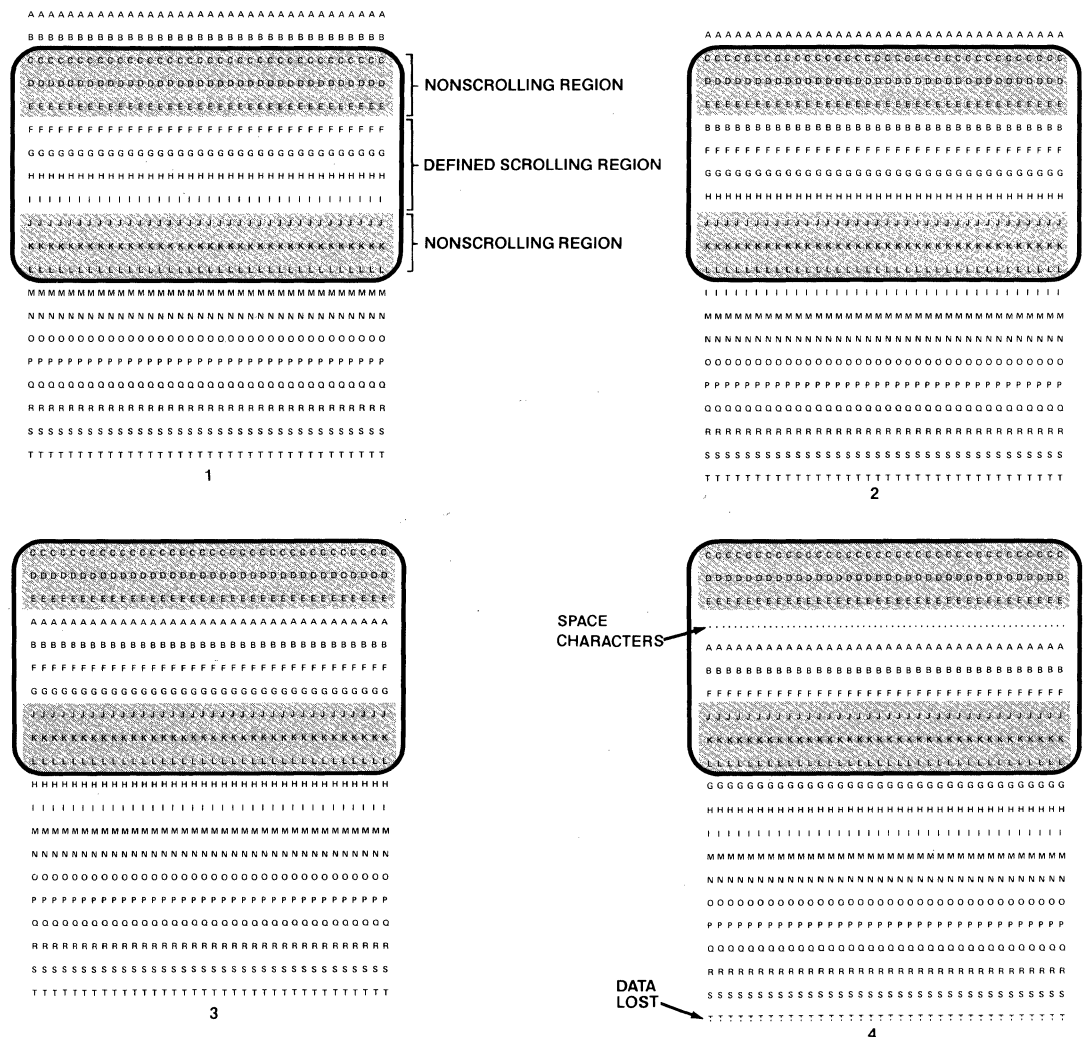

Creating Protected Forms

Why Protect Mode and Logical Attributes Are Available

Protect mode permits you to create forms with permanent (protected) headings and blank areas to be filled later with certain types of data. Figure 4-11 shows a typical form. Unless you protect the headings first, an operator could accidentally delete or change them.

Figure 4-11
Sample Protected Form with Spaces Left for Data Entry

Item:	Qty:	Part Number and Description:	Unit Price:	Total Cost:
1				
2				
3				
4				
5				
6				
7				
8				
9				
10				

Protect mode allows you to:

- Protect designated areas of a page from accidental change

- Specify (with logical attributes) the type and amount of data that the operator can enter in an unprotected area

- Control transmission of those areas

For example, suppose you need to create a payroll form. Some information must be furnished and the type of information is always the same. The social security number always has nine numbers and alpha characters are never used. You can create a form that includes those requirements by assigning a **logical** attribute to that area. If the operator accidentally enters an alpha character in the social security number space, the bell rings. The incorrect data is not displayed on the screen; the cursor remains in that area until the entry is corrected.

Assigning Logical Attributes

Assign logical attribute(s) to current unprotected field

ESC g n

where

n = One or more values defining the data allowed in the next unprotected area

n	Attribute
1	Can enter only alphabetic characters ^{1, 2}
2	Can enter only numeric characters ^{2, 3}
4	Must enter some data of any type
5	Must enter only alphabetic characters
6	Must enter only numeric characters
8	Must fill totally with any data ⁴
9	Must fill totally with only alphabetic characters ⁴
:	Must fill totally with only numeric characters ⁴

1. Alphabetic only data is defined as all upper/lowercase alphabetic characters plus space, comma, and period.
2. Alphabetic only and numeric only fields can not be defined concurrently; i.e., can not be 3, 7, and semicolon.
3. Numeric only data is defined as all numerals (0 through 9), plus the symbols asterisk, plus sign, comma, hyphen, period, and slash.
4. Any total fill field is also a must enter field.

When protect mode is on, this command is ignored.

NOTE! Each logical attribute value occupies one character position and appears as a space. Use insert mode if necessary to maintain the current number of spaces. Each logical attribute decreases the line's data capacity by one (even if more than one value is given to the attribute). For example, if you enter a total of six logical attribute values for three unprotected areas, the line can contain 77 characters, not 74.

Logical Attribute Mode Logical attribute mode on or off ESC o n

where

n defines whether the mode is off or on.

n	Effect
0	Off
1	On

You must turn on protect mode before turning on this mode.

This command moves the cursor to the page's first unprotected position and turns off the write protect mode.

While this mode is on, the only valid cursor movement commands are cursor right, cursor left, field tab, field back tab. All other cursor movement commands (such as line feed, reverse line feed, cursor up, cursor down, cursor addressing, carriage return, and new line) are illegal and cause the terminal to ring the bell.

Space and null characters resulting from clear commands (i.e., clear unprotected data, erase to end of line or page, and clear entry) are not considered as characters while this mode is enabled.

If the operator enters the wrong type of character, the bells rings. The incorrect character is not displayed.

If the current field is defined as a total fill field and at least one position is unfilled when the terminal receives a cursor right or field tab command, the bell rings and the cursor moves to the first unfilled position in that field and remains in the field until it is totally filled.

If autopage mode is on when any of the four cursor control commands (up, down, right, and left) move the cursor to the page boundary, the display flips to the next page and the cursor moves to that page's first unprotected position.

While protect and logical attribute modes are on, moving the cursor to the next or previous page no longer returns it to its previous position on that page. Instead, it goes to the first unprotected position.

Turning off protect mode automatically disables this mode also.

Controlling Protected Writing and Protect Modes

Write protect mode on	STATUS
Write protect mode off	ESC)
Protect mode on	ESC (
Protect mode off	ESC & ESC '

Make sure protect and logical attribute modes are disabled before turning on write protect mode. If they are not, the bell will ring. Turning off protect mode also turns off the logical attribute mode.

Steps Involved in Protect Mode

- Protect mode involves two procedures:
1. Enter data to be protected in write protect mode
 2. Guard all data by turning on protect mode

Procedure for Entering Data To Be Protected

1. Position the cursor where you want to enter the first protected character.
2. Enter
ESC)
to activate write protect mode.
NOTE! *You must turn on write protect mode before entering data to be protected or you can not protect the information later.*
3. Look for W.P. in the status line (if the status line is displayed). This confirms that you can protect this data later.
4. Enter any visual attributes, then enter the information to be protected in that screen area.
5. Proofread the entry and correct it if necessary.
6. Enter
ESC (
to turn off write protect mode.
7. Decide if you want to include a logical attribute to define the type and amount of data to be entered in the next unprotected area. If so, enter it now.

8. Move the cursor to the next area to be write-protected and repeat Steps 1 through 7.

NOTE! *The form you create is not limited by the line capacity of the screen, only by the defined page.*

9. Turn on protect mode. This protects the **whole form** from change.

10. Turn on logical attribute mode.

NOTE! *The cursor can be anywhere when you turn on protect mode. If it is in a write-protected field, however, it moves to the next unprotected character position (now a field tab, as described below) since it can not remain in a protected field.*

If you attempt to turn on protect mode while the entire screen is write protected, the terminal ignores the command to enable protect mode. Or if you enter a whole page in write protect mode, then leave the page and later try to return to that page, the terminal automatically turns off protect mode.

The status line contains **PROT** when protect mode is on, indicating that no one can change data in the protected fields.

When protect mode is off, the form has no protection. The absence of **PROT** on the status line indicates that protect mode is off.

Effects of Protect Mode

Tab Stops—The first unprotected position after a write-protected field automatically becomes a field tab stop as soon as you enable protect mode.

Data Appearance—Protected data appears with the visual attribute(s) in effect when it was written.

Cursor Movement—You can never move the visible cursor into a write-protected field. To move it into a write-protected area, remove the protection by turning off protect mode.

NOTE! *The hidden cursor can enter any area, without restriction.*

Protect mode protects data from possible loss. (Since protected data can not scroll off the page, it is not lost when the terminal receives line feed or reverse line feed codes.)

While protect mode is on, the TAB key or tab command moves the cursor to the first unprotected position following a write-protected position (since it automatically became a field tab stop when you enabled protect mode).

Data Entry—Entering a character on the page's last unprotected position while write protect and protect modes are on turns off write protect and protect modes. This ensures that the cursor does not rest in a protected field.

Cursor Control

Line Feed and Reverse Line Feed

Line feed	CTRL J
Reverse line feed	ESC j

A line feed code moves the cursor down one line within the same column. A reverse line feed code moves it up instead.

The defined scrolling region and the autopage and protect modes determine where the terminal moves the cursor after it receives a line feed or reverse line feed code. Tables 4-7 and 4-8 summarize these effects.

STOP! Under certain conditions, line feed and reverse line feed codes received by the terminal may result in the loss of data. Read the following tables carefully.

Table 4-7
Effect of Line Feed Codes on Cursor Movement

Modes		Effect
Autopage	Protect	
Off	Off	Advances the cursor to the next line. Each line feed code received while the cursor is on the scrolling region's bottom line rolls the display up one line.

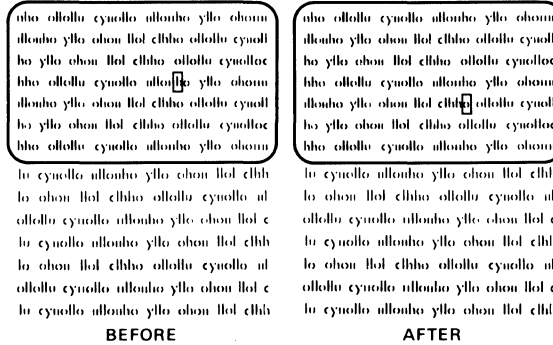

If the cursor is at the bottom of the page (not the screen), a new line of space characters appears at the bottom of the page and the page's top line is lost, as shown below.

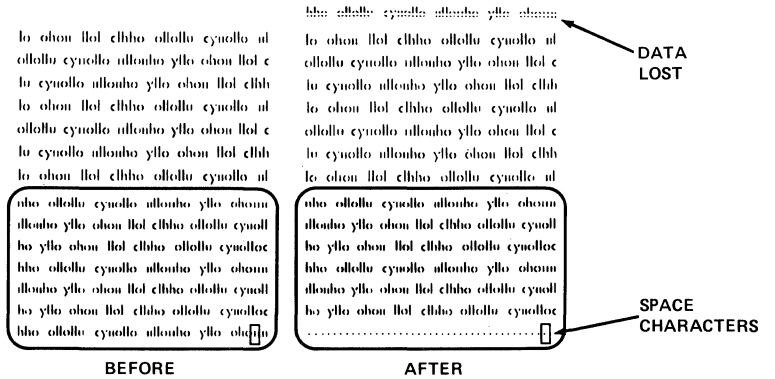

Off	On	A line feed code received when the cursor is just above a protected area moves the cursor down to the next unprotected character position, regardless of its column position.
-----	----	---

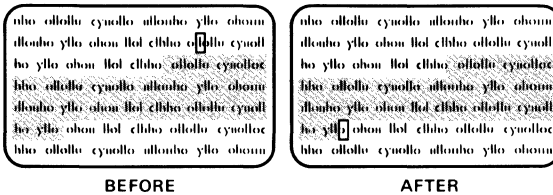

Table 4-7
Continued

Modes		Effect
Autopage	Protect	
Off	On	<p>After the cursor reaches the last unprotected line of the page, another line feed code returns the cursor to the first unprotected line on the current page.</p> <div style="display: flex; justify-content: space-around;"> <div style="border: 1px solid black; padding: 5px; width: 45%;"> <p>lo ohon llof elhho ollollu cyuollo ul ollollu cyuollo ullonho ylllo ohon llof e lu cyuollo ullonho ylllo ohon llof elhh lo ohon llof elhho ollollu cyuollo ul ollollu cyuollo ullonho ylllo ohon llof e lu cyuollo ullonho ylllo ohon llof elhh lo ohon llof elhho ollollu cyuollo ul</p> </div> <div style="border: 1px solid black; padding: 5px; width: 45%;"> <p>hho ollollu cyuollo ullonho ylllo ohon ullonho ylllo ohon llof elhho ollollu cyuoll ho ylllo ohon llof elhho ollollu cyuoll hho ollollu cyuollo ullonho ylllo ohon ullonho ylllo ohon llof elhho ollollu cyuoll ho ylllo ohon llof elhho ollollu cyuoll hho ollollu cyuollo ullonho ylllo ohon ullonho ylllo ohon llof elhho ollollu cyuoll</p> </div> </div> <p style="text-align: center;">BEFORE AFTER</p>
On	Off/On	<p>Line feed advances the cursor to the next line on the page. When the cursor reaches the last unprotected line on that page, it advances to the first unprotected line on the next page and the screen displays the first 24 lines of that next page.</p> <div style="display: flex; justify-content: space-around;"> <div style="border: 1px solid black; padding: 5px; width: 45%;"> <p>lo ohon llof elhho ollollu cyuollo ul ollollu cyuollo ullonho ylllo ohon llof e lu cyuollo ullonho ylllo ohon llof elhh lo ohon llof elhho ollollu cyuollo ul ollollu cyuollo ullonho ylllo ohon llof e lu cyuollo ullonho ylllo ohon llof elhh lo ohon llof elhho ollollu cyuollo ul</p> </div> <div style="border: 1px solid black; padding: 5px; width: 45%;"> <p>hho ollollu cyuollo ullonho ylllo ohon ullonho ylllo ohon llof elhho ollollu cyuoll ho ylllo ohon llof elhho ollollu cyuoll hho ollollu cyuollo ullonho ylllo ohon ullonho ylllo ohon llof elhho ollollu cyuoll ho ylllo ohon llof elhho ollollu cyuoll hho ollollu cyuollo ullonho ylllo ohon ullonho ylllo ohon llof elhho ollollu cyuoll</p> </div> </div> <p style="text-align: center;">PAGE 1 PAGE 2 PAGE 1 PAGE 2</p> <p style="text-align: center;">BEFORE AFTER</p>
		<p>When the cursor reaches the last unprotected line of the last page, it advances to the first unprotected line of the first page.</p> <div style="display: flex; justify-content: space-around;"> <div style="border: 1px solid black; padding: 5px; width: 45%;"> <p>lo ohon llof elhho ollollu cyuollo ul ollollu cyuollo ullonho ylllo ohon llof e lu cyuollo ullonho ylllo ohon llof elhh lo ohon llof elhho ollollu cyuollo ul ollollu cyuollo ullonho ylllo ohon llof e lu cyuollo ullonho ylllo ohon llof elhh lo ohon llof elhho ollollu cyuollo ul</p> </div> <div style="border: 1px solid black; padding: 5px; width: 45%;"> <p>hho ollollu cyuollo ullonho ylllo ohon ullonho ylllo ohon llof elhho ollollu cyuoll ho ylllo ohon llof elhho ollollu cyuoll hho ollollu cyuollo ullonho ylllo ohon ullonho ylllo ohon llof elhho ollollu cyuoll ho ylllo ohon llof elhho ollollu cyuoll hho ollollu cyuollo ullonho ylllo ohon ullonho ylllo ohon llof elhho ollollu cyuoll</p> </div> </div> <p style="text-align: center;">PAGE 1 PAGE 2 PAGE 1 PAGE 2</p> <p style="text-align: center;">BEFORE AFTER</p>

Table 4-8
Effect of Reverse Line Feed Codes on Cursor Movement

Modes		Effect
Autopage	Protect	

Off Off The display scrolls down one line when the cursor is on the first line of the current page. Data on the page's last line is lost.

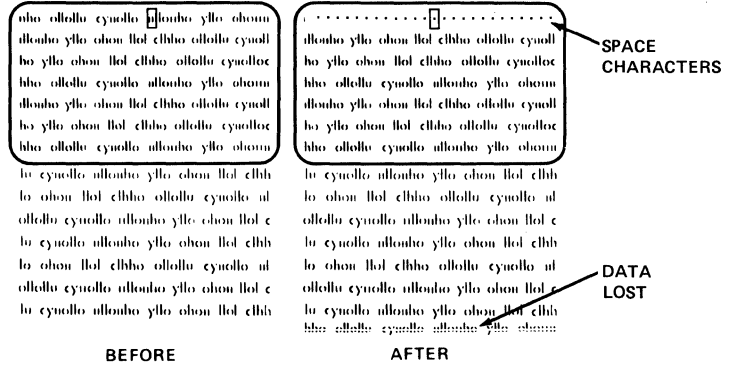

On Off When the cursor reaches the first line of the current page, it moves to the last line of the previous page.

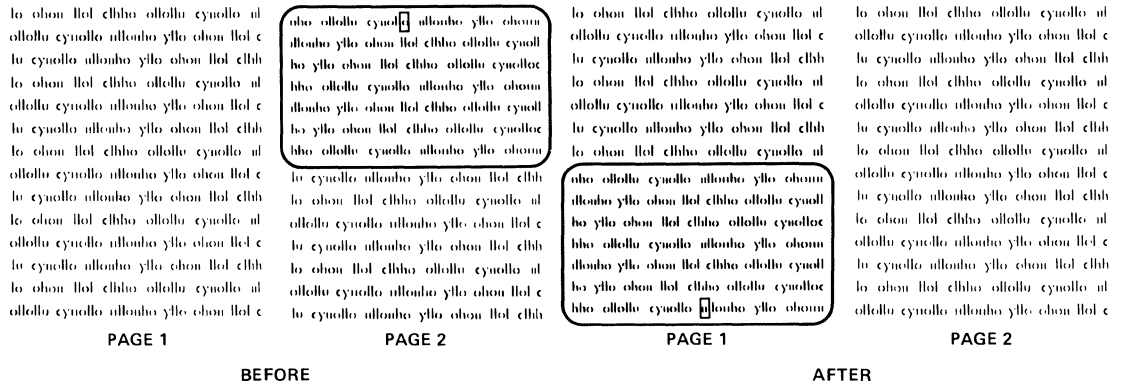

When the cursor reaches the first line of the first page, it does not move any further.

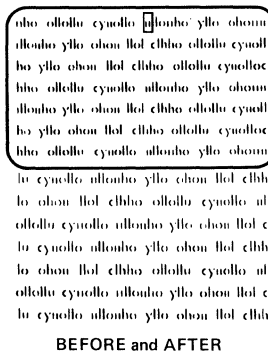

**Table 4-8
Continued**

Modes		Effect
Autopage	Protect	
On	On	<p>A reverse line feed code received when the cursor is just below a protected position moves the cursor up to the first unprotected character position, regardless of the column position.</p> <div style="display: flex; justify-content: space-around; align-items: center;"> <div style="border: 1px solid black; padding: 5px; text-align: center;"> <p>hbo allllu cyuollo allouho ylo ohonu allouho ylo ohon lol ellho allllu cyuall ho ylo ohon lol ellho allllu cyuall hbo allllu cyuollo allouho ylo ohonu allouho ylo ohon lol ellho allllu cyuall ho ylo ohon lol ellho allllu cyuall hbo allllu cyuollo allouho ylo ohonu</p> <p>BEFORE</p> </div> <div style="border: 1px solid black; padding: 5px; text-align: center;"> <p>hbo allllu cyuollo allouho ylo ohonu allouho ylo ohon lol ellho allllu cyuall ho ylo ohon lol ellho allllu cyuall hbo allllu cyuollo allouho ylo ohonu allouho ylo ohon lol ellho allllu cyuall ho ylo ohon lol ellho allllu cyuall hbo allllu cyuollo allouho ylo ohonu</p> <p>AFTER</p> </div> </div>
Off	On	<p>If the terminal receives a reverse line feed code when the cursor is on the first unprotected character position on the page, the cursor does not move.</p> <div style="border: 1px solid black; padding: 5px; text-align: center;"> <p>hbo allllu cyuollo allouho ylo ohonu allouho ylo ohon lol ellho allllu cyuall ho ylo ohon lol ellho allllu cyuall hbo allllu cyuollo allouho ylo ohonu allouho ylo ohon lol ellho allllu cyuall ho ylo ohon lol ellho allllu cyuall hbo allllu cyuollo allouho ylo ohonu</p> <p>BEFORE and AFTER</p> </div>

**Directional Cursor
Movement**

Move cursor up	SET UP
Move cursor down	CTRL K
Move cursor left	CTRL V
Move cursor right	CTRL H
Carriage return	CTRL L
Move cursor to home position	CTRL M
New line (carriage return and line feed)	CTRL ^
	CTRL _

NOTE! The cursor right and left commands move the cursor over a protected field; the cursor up and down commands can not. Table 4-9 summarizes directional cursor movement commands.

Table 4-9
Cursor Movement

Control Code	Modes Autopage ¹	Protect	Effect
Cursor up	Off/ On	Off	Moves the cursor up one line within the present column until it reaches the top of the display. If the first displayed line is below the page's first line, each code rolls the display down one line until the cursor reaches the page's first line. Additional CTRL K codes have no effect.
			<div style="display: flex; justify-content: space-around;"> <div style="border: 1px solid black; padding: 5px; width: 30%;"> <p>lo ohou llof ellho ollollu cyuollo ul nho ollollu cyuollo ullonho ylo ohou ullonho ylo ohou llof ellho ollollu cyuoll ho ylo ohou llof ellho ollollu cyuoll hho ollollu cyuollo ullonho ylo ohou ullonho ylo ohou llof ellho ollollu cyuoll ho ylo ohou llof ellho ollollu cyuoll hho ollollu cyuollo ullonho ylo ohou</p> </div> <div style="border: 1px solid black; padding: 5px; width: 30%;"> <p>lo ohou llof ellho ollollu cyuollo ul nho ollollu cyuollo ullonho ylo ohou ullonho ylo ohou llof ellho ollollu cyuoll ho ylo ohou llof ellho ollollu cyuoll hho ollollu cyuollo ullonho ylo ohou ullonho ylo ohou llof ellho ollollu cyuoll ho ylo ohou llof ellho ollollu cyuoll hho ollollu cyuollo ullonho ylo ohou</p> </div> <div style="border: 1px solid black; padding: 5px; width: 30%;"> <p>nho ollollu cyuollo ullonho ylo ohou ullonho ylo ohou llof ellho ollollu cyuoll ho ylo ohou llof ellho ollollu cyuoll hho ollollu cyuollo ullonho ylo ohou ullonho ylo ohou llof ellho ollollu cyuoll ho ylo ohou llof ellho ollollu cyuoll hho ollollu cyuollo ullonho ylo ohou ullonho ylo ohou llof ellho ollollu cyuoll</p> </div> </div> <div style="display: flex; justify-content: space-around; margin-top: 5px;"> BEFORE AFTER AFTER </div>
	On	On	A cursor up command received when the cursor is just below a protected position returns it to the first unprotected character position, regardless of the column position.
			<div style="display: flex; justify-content: space-around;"> <div style="border: 1px solid black; padding: 5px; width: 45%;"> <p>nho ollollu cyuollo ullonho ylo ohou ullonho ylo ohou llof ellho ollollu cyuoll ho ylo ohou llof ellho ollollu cyuoll hho ollollu cyuollo ullonho ylo ohou ullonho ylo ohou llof ellho ollollu cyuoll ho ylo ohou llof ellho ollollu cyuoll hho ollollu cyuollo ullonho ylo ohou</p> </div> <div style="border: 1px solid black; padding: 5px; width: 45%;"> <p>nho ollollu cyuollo ullonho ylo ohou ullonho ylo ohou llof ellho ollollu cyuoll ho ylo ohou llof ellho ollollu cyuoll hho ollollu cyuollo ullonho ylo ohou ullonho ylo ohou llof ellho ollollu cyuoll ho ylo ohou llof ellho ollollu cyuoll hho ollollu cyuollo ullonho ylo ohou</p> </div> </div> <div style="display: flex; justify-content: space-around; margin-top: 5px;"> BEFORE AFTER </div>
	Off	On	If the terminal receives a reverse line feed code when the cursor is on the page's first unprotected character position, the cursor does not move. (Since autopage is off, it can not move to the previous page's last line.)
			<div style="display: flex; justify-content: space-between;"> <div style="width: 45%;"> <p>lo ohou llof ellho ollollu cyuollo ul ollollu cyuollo ullonho ylo ohou llof e lu cyuollo ullonho ylo ohou llof ellh lo ohou llof ellho ollollu cyuollo ul ollollu cyuollo ullonho ylo ohou llof e lu cyuollo ullonho ylo ohou llof ellh lo ohou llof ellho ollollu cyuollo ul ollollu cyuollo ullonho ylo ohou llof e lu cyuollo ullonho ylo ohou llof ellh lo ohou llof ellho ollollu cyuollo ul ollollu cyuollo ullonho ylo ohou llof e</p> <p style="text-align: center;">PAGE 1</p> </div> <div style="width: 45%;"> <p>ollollu cyuollo ullonho ylo ohou llof e lu cyuollo ullonho ylo ohou llof ellh lo ohou llof ellho ollollu cyuollo ul ollollu cyuollo ullonho ylo ohou llof e lu cyuollo ullonho ylo ohou llof ellh lo ohou llof ellho ollollu cyuollo ul ollollu cyuollo ullonho ylo ohou llof e lu cyuollo ullonho ylo ohou llof ellh lo ohou llof ellho ollollu cyuollo ul ollollu cyuollo ullonho ylo ohou llof e</p> <p style="text-align: center;">PAGE 2</p> </div> </div> <div style="text-align: center; margin-top: 5px;">BEFORE and AFTER</div>

1. If optional memory is installed.

Table 4-9
Continued

Control Code	Modes		Effect
	Autopage ¹	Protect	
Cursor down	Off/ On	Off	Moves the cursor down one line within column. When it reaches the screen's 24th line, each code rolls the screen up until the cursor reaches the page's last line. Subsequent CTRL V codes have no effect.

NOTE! Set up parameters determine whether or not the ↓ key transmits this code or CTRL J.

lu cyuollo nllonho ylllo ohon llol ellho
lo ohon llol ellho ollollu cyuollo ul
ollollu cyuollo nllonho ylllo ohon llol c
lu cyuollo nllonho ylllo ohon llol ellho
lo ohon llol ellho ollollu cyuollo ul

nho ollollu cyuollo nllonho ylllo ohon
nllonho ylllo ohon llol ellho ollollu cyuoll
ho ylllo ohon llol ellho ollollu cyuoll
hho ollollu cyuollo nllonho ylllo ohon
nllonho ylllo ohon llol ellho ollollu cyuoll
ho ylllo ohon llol ellho ollollu cyuoll
hho ollollu cyuollo nllonho ylllo ohon
lu cyuollo nllonho ylllo ohon llol ellho
lo ohon llol ellho ollollu cyuollo ul

BEFORE

ollollu cyuollo nllonho ylllo ohon llol c
lu cyuollo nllonho ylllo ohon llol ellho
lo ohon llol ellho ollollu cyuollo ul
ollollu cyuollo nllonho ylllo ohon llol c
lu cyuollo nllonho ylllo ohon llol ellho
lo ohon llol ellho ollollu cyuollo ul

nho ollollu cyuollo nllonho ylllo ohon
nllonho ylllo ohon llol ellho ollollu cyuoll
ho ylllo ohon llol ellho ollollu cyuoll
hho ollollu cyuollo nllonho ylllo ohon
nllonho ylllo ohon llol ellho ollollu cyuoll
ho ylllo ohon llol ellho ollollu cyuoll
hho ollollu cyuollo nllonho ylllo ohon
lu cyuollo nllonho ylllo ohon llol ellho
lo ohon llol ellho ollollu cyuollo ul

AFTER

lo ohon llol ellho ollollu cyuollo ul
ollollu cyuollo nllonho ylllo ohon llol c
lu cyuollo nllonho ylllo ohon llol ellho
lo ohon llol ellho ollollu cyuollo ul
ollollu cyuollo nllonho ylllo ohon llol c
lu cyuollo nllonho ylllo ohon llol ellho
lo ohon llol ellho ollollu cyuollo ul

nho ollollu cyuollo nllonho ylllo ohon
nllonho ylllo ohon llol ellho ollollu cyuoll
ho ylllo ohon llol ellho ollollu cyuoll
hho ollollu cyuollo nllonho ylllo ohon
nllonho ylllo ohon llol ellho ollollu cyuoll
ho ylllo ohon llol ellho ollollu cyuoll
hho ollollu cyuollo nllonho ylllo ohon
lu cyuollo nllonho ylllo ohon llol ellho
lo ohon llol ellho ollollu cyuollo ul

AFTER

	Off/ On	On	Same as line feed except the cursor does not move when it reaches the page's last line.
Cursor left	Off/ On	Off/ On	Same effect as BACKSPACE key. Moves the cursor left to the previous unprotected position. If the cursor is in the line's first column, it moves to the previous line's last column, regardless of autopage mode.

nho ollollu cyuollo nllonho ylllo ohon
nllonho ylllo ohon llol ellho ollollu cyuoll
ho ylllo ohon llol ellho ollollu cyuoll
hho ollollu cyuollo nllonho ylllo ohon
nllonho ylllo ohon llol ellho ollollu cyuoll
ho ylllo ohon llol ellho ollollu cyuoll
hho ollollu cyuollo nllonho ylllo ohon
lu cyuollo nllonho ylllo ohon llol ellho
lo ohon llol ellho ollollu cyuollo ul

nho ollollu cyuollo nllonho ylllo ohon
nllonho ylllo ohon llol ellho ollollu cyuoll
ho ylllo ohon llol ellho ollollu cyuoll
hho ollollu cyuollo nllonho ylllo ohon
nllonho ylllo ohon llol ellho ollollu cyuoll
ho ylllo ohon llol ellho ollollu cyuoll
hho ollollu cyuollo nllonho ylllo ohon
lu cyuollo nllonho ylllo ohon llol ellho
lo ohon llol ellho ollollu cyuollo ul

BEFORE

nho ollollu cyuollo nllonho ylllo ohon
nllonho ylllo ohon llol ellho ollollu cyuoll
ho ylllo ohon llol ellho ollollu cyuoll
hho ollollu cyuollo nllonho ylllo ohon
nllonho ylllo ohon llol ellho ollollu cyuoll
ho ylllo ohon llol ellho ollollu cyuoll
hho ollollu cyuollo nllonho ylllo ohon
lu cyuollo nllonho ylllo ohon llol ellho
lo ohon llol ellho ollollu cyuollo ul

nho ollollu cyuollo nllonho ylllo ohon
nllonho ylllo ohon llol ellho ollollu cyuoll
ho ylllo ohon llol ellho ollollu cyuoll
hho ollollu cyuollo nllonho ylllo ohon
nllonho ylllo ohon llol ellho ollollu cyuoll
ho ylllo ohon llol ellho ollollu cyuoll
hho ollollu cyuollo nllonho ylllo ohon
lu cyuollo nllonho ylllo ohon llol ellho
lo ohon llol ellho ollollu cyuollo ul

AFTER

nho ollollu cyuollo nllonho ylllo ohon
nllonho ylllo ohon llol ellho ollollu cyuoll
ho ylllo ohon llol ellho ollollu cyuoll
hho ollollu cyuollo nllonho ylllo ohon
nllonho ylllo ohon llol ellho ollollu cyuoll
ho ylllo ohon llol ellho ollollu cyuoll
hho ollollu cyuollo nllonho ylllo ohon
lu cyuollo nllonho ylllo ohon llol ellho
lo ohon llol ellho ollollu cyuollo ul

nho ollollu cyuollo nllonho ylllo ohon
nllonho ylllo ohon llol ellho ollollu cyuoll
ho ylllo ohon llol ellho ollollu cyuoll
hho ollollu cyuollo nllonho ylllo ohon
nllonho ylllo ohon llol ellho ollollu cyuoll
ho ylllo ohon llol ellho ollollu cyuoll
hho ollollu cyuollo nllonho ylllo ohon
lu cyuollo nllonho ylllo ohon llol ellho
lo ohon llol ellho ollollu cyuollo ul

AFTER

	Off	Off/ On	If autopage is off and the cursor is on the first page's unprotected position, additional CTRL H codes have no effect.
--	-----	------------	--

nho ollollu cyuollo nllonho ylllo ohon
nllonho ylllo ohon llol ellho ollollu cyuoll
ho ylllo ohon llol ellho ollollu cyuoll
hho ollollu cyuollo nllonho ylllo ohon
nllonho ylllo ohon llol ellho ollollu cyuoll
ho ylllo ohon llol ellho ollollu cyuoll
hho ollollu cyuollo nllonho ylllo ohon
lu cyuollo nllonho ylllo ohon llol ellho
lo ohon llol ellho ollollu cyuollo ul

nho ollollu cyuollo nllonho ylllo ohon
nllonho ylllo ohon llol ellho ollollu cyuoll
ho ylllo ohon llol ellho ollollu cyuoll
hho ollollu cyuollo nllonho ylllo ohon
nllonho ylllo ohon llol ellho ollollu cyuoll
ho ylllo ohon llol ellho ollollu cyuoll
hho ollollu cyuollo nllonho ylllo ohon
lu cyuollo nllonho ylllo ohon llol ellho
lo ohon llol ellho ollollu cyuollo ul

PAGE 1



lo ohon llol ellho ollollu cyuollo ul
ollollu cyuollo nllonho ylllo ohon llol c
lu cyuollo nllonho ylllo ohon llol ellho
lo ohon llol ellho ollollu cyuollo ul
ollollu cyuollo nllonho ylllo ohon llol c
lu cyuollo nllonho ylllo ohon llol ellho
lo ohon llol ellho ollollu cyuollo ul
ollollu cyuollo nllonho ylllo ohon llol c
lu cyuollo nllonho ylllo ohon llol ellho
lo ohon llol ellho ollollu cyuollo ul
ollollu cyuollo nllonho ylllo ohon llol c
lu cyuollo nllonho ylllo ohon llol ellho
lo ohon llol ellho ollollu cyuollo ul

PAGE 2

BEFORE AND AFTER

1. If optional memory is installed.

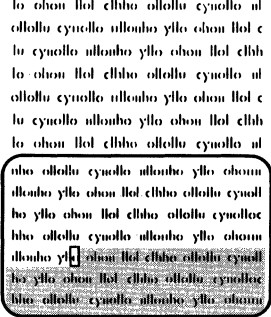
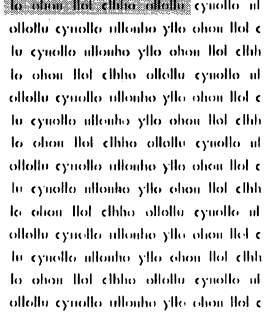
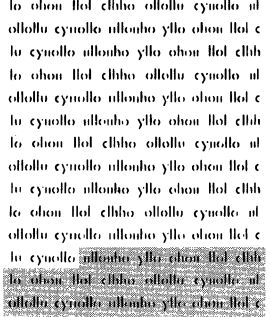
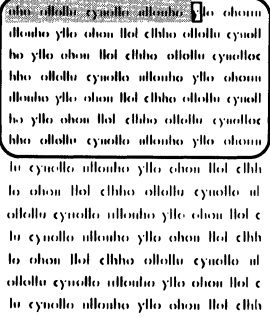
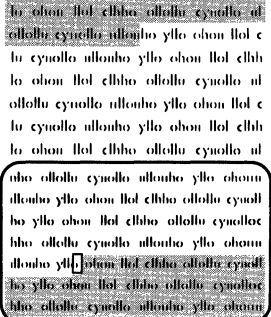
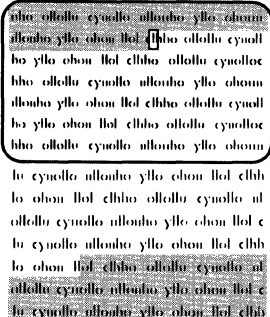
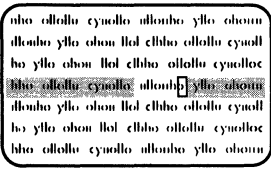
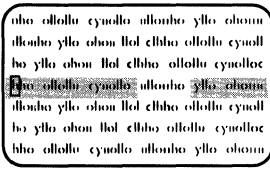
Table 4-9
Continued

Control Code	Modes		Effect
	Autopage ¹	Protect	
	On	Off/ On	If the cursor is on the page's last unprotected position, it moves to the next page's first unprotected position. If on the last page, it advances to the first page's first unprotected position.
	<div style="display: flex; justify-content: space-around;"> <div style="text-align: center;"> <p>PAGE 1</p>  <p>BEFORE</p> </div> <div style="text-align: center;"> <p>PAGE 2</p>  <p>BEFORE</p> </div> <div style="text-align: center;"> <p>PAGE 1</p>  <p>AFTER</p> </div> <div style="text-align: center;"> <p>PAGE 2</p>  <p>AFTER</p> </div> </div>		
	Off	On	If the cursor is on the page's last unprotected position, it moves to the current page's first unprotected position.
	<div style="display: flex; justify-content: space-around;"> <div style="text-align: center;"> <p>BEFORE</p>  <p>BEFORE</p> </div> <div style="text-align: center;"> <p>AFTER</p>  <p>AFTER</p> </div> </div>		
Carriage return	Off/ On	Off/ On	Moves the cursor to the current line's first unprotected position. ²
	<div style="display: flex; justify-content: space-around;"> <div style="text-align: center;"> <p>BEFORE</p>  <p>BEFORE</p> </div> <div style="text-align: center;"> <p>AFTER</p>  <p>AFTER</p> </div> </div>		
	Off/ On	On	If the cursor is on the line's only unprotected position, it does not move.
	<div style="text-align: center;"> <p>BEFORE and AFTER</p>  <p>BEFORE and AFTER</p> </div>		

1. If optional memory is installed.
2. When carriage return/line feed parameter has been selected in set up line, performs a carriage return, then a line feed.

Table 4-9
Continued

Control Code	Modes Autopage¹	Protect	Effect
Home	Off	On	Moves the cursor to the page's first unprotected position. Has no effect if it is already there.
			<div style="display: flex; justify-content: space-around;"> <div style="border: 1px solid black; padding: 5px; width: 45%;"> <p>lo ohon lol elhho ollllu cyuollo ul ollllu cyuollo ullunho ylo ohon lol c lu cyuollo ullunho ylo ohon lol elh lo ohon lol elhho ollllu cyuollo ul ollllu cyuollo ullunho ylo ohon lol c lu cyuollo ullunho ylo ohon lol elh lo ohon lol elhho ollllu cyuollo ul</p> </div> <div style="border: 1px solid black; padding: 5px; width: 45%;"> <p>lho ollllu cyuollo ullunho ylo ohon ullunho ylo ohon lol elhho ollllu cyuol ho ylo ohon lol elhho ollllu cyuolloc lho ollllu cyuollo ullunho ylo ohon ullunho ylo ohon lol elhho ollllu cyuol ho ylo ohon lol elhho ollllu cyuolloc lho ollllu cyuollo ullunho ylo ohon</p> </div> </div> <div style="display: flex; justify-content: space-around; margin-top: 5px;"> BEFORE AFTER </div>
New line	Off/ On	Off/ On	Same as carriage return and line feed.
			<div style="display: flex; justify-content: space-around;"> <div style="border: 1px solid black; padding: 5px; width: 45%;"> <p>lho ollllu cyuollo ullunho ylo ohon ullunho ylo ohon lol elhho ollllu cyuol ho ylo ohon lol elhho ollllu cyuolloc lho ollllu cyuollo ullunho ylo ohon ullunho ylo ohon lol elhho ollllu cyuol ho ylo ohon lol elhho ollllu cyuolloc lho ollllu cyuollo ullunho ylo ohon</p> </div> <div style="border: 1px solid black; padding: 5px; width: 45%;"> <p>lho ollllu cyuollo ullunho ylo ohon ullunho ylo ohon lol elhho ollllu cyuol ho ylo ohon lol elhho ollllu cyuolloc lho ollllu cyuollo ullunho ylo ohon ullunho ylo ohon lol elhho ollllu cyuol ho ylo ohon lol elhho ollllu cyuolloc lho ollllu cyuollo ullunho ylo ohon</p> </div> </div> <div style="display: flex; justify-content: space-around; margin-top: 5px;"> BEFORE AFTER </div>

1. If optional memory is installed.

Addressing and Reading the Cursor

Addressing the Cursor

Send (address) cursor to specific page, row, column

ESC - p r c

Send (address) cursor to specific row and column in current page

ESC = r c

where

p is a value for the page number.

p Value	Page
0	One
1	Two
2	Three
3	Four

NOTE! The maximum value of p is determined by the number of pages of memory installed.

r is an ASCII character from Appendix E for the row (line).

c is an ASCII character from Appendix E for the column.

NOTE! If your computer inserts nulls between characters, addressing the cursor moves it to an unpredictable position. If the cursor address is in a nonexistent or nonscrolling area, the command has no effect on the cursor.

The computer can move (address) the cursor to a particular location by sending one of these commands to the terminal. If a scrolling region has been defined, line numbers refer only to the lines within the scrolling region. Figure 4-12 shows line numbers in relation to a screen without a scrolling region and in relation to a screen with a scrolling region.

Figure 4-12
Line Numbers in Relation to Scrolling Region

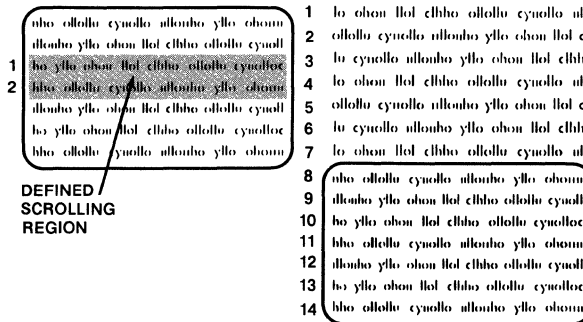

These commands allow the computer to position the cursor in a specific location within a page of the terminal's memory. This function is called **addressing** or **loading** the cursor.

For example,

ESC = " Q

sends the cursor to row 9, column 50 of the current page when the scrolling region starts on line 8.

Reading the Cursor

Read cursor's page, row, and column position
Read cursor's row and column position

ESC /
ESC ?

where

The terminal's response contains values for the cursor's page, row (line), and column positions.

The page number is one of the following values:

Value	Page
0	One
1	Two
2	Three
3	Four

Row and column positions are reported as values from Appendix E.

The report is terminated with a carriage return code.

These commands tell the terminal to report (i.e., read) the cursor's current position to the computer.

Hidden Cursor

Send data to hidden cursor

ESC L p r c (text) CTRL Y

where

p is a value for the page number.

p Value	Page
0	One
1	Two
2	Three
3	Four

The maximum value of p is determined by the number of pages in the memory.

r is a row (line) value from from Table E-1 in Appendix E referring to a line of that page's memory (unrelated to the defined scrolling region).

c is a column value from Table E-1 in Appendix E.

Entering CTRL P in the text stores the next character, even if it is a CTRL P or CTRL Y.

NOTE! All modes and defined scrolling regions are irrelevant. You can address the hidden cursor to any location in the screen's memory.

Define any visual attribute or enable write protect mode just before sending data through the hidden cursor. Then redefine the visual attribute or change the mode afterwards.

This command allows the computer to send text to any position in memory, even if that position is not currently displayed. Only with hidden cursor can you add data to a protected area or outside the currently defined scrolling region.

The type of data written (i.e., protected or unprotected) depends on which mode is in effect.

The command displays all ASCII characters received. No functions are performed. For example, if the terminal receives a CR code through the hidden cursor, it displays CR in one character position instead of performing a carriage return. (Refer to monitor mode earlier in this chapter.)

You might use the hidden cursor feature to build a form on a page without having to display the page and redefine the scrolling region.

Function Keys

The function keys (F1 through F16) send a programmable sequence to the display, to the computer, or to the computer and the display. You can reprogram any function key (shifted and unshifted), as shown in the next chapter.

Default Values

Table 4-10 lists the default five-code sequences sent by each function key.

NOTE! The function key values shown here are the factory default values. Since the values come from the nonvolatile memory, they may have been subsequently reprogrammed.

Table 4-10
Default Function Key Codes

Function Key	Unshifted	Code ¹	Shifted
F1	SOH @ CR		SOH ` CR
F2	SOH A CR		SOH a CR
F3	SOH B CR		SOH b CR
F4	SOH C CR		SOH c CR
F5	SOH D CR		SOH d CR
F6	SOH E CR		SOH e CR
F7	SOH F CR		SOH f CR
F8	SOH G CR		SOH g CR
F9	SOH H CR		SOH h CR
F10	SOH I CR		SOH i CR
F11	SOH J CR		SOH j CR
F12	SOH K CR		SOH k CR
F13	SOH L CR		SOH l CR
F14	SOH M CR		SOH m CR
F15	SOH N CR		SOH n CR
F16	SOH O CR		SOH o CR

1. Refer to ASCII Code Conversion Table in Appendix C.

NOTE! *Function key codes are transmitted sequentially. If you press a function key while other data is being transmitted, the function key's code is transmitted after the terminal transmits the other data. If your computer cannot accept codes at that speed, you may have to modify your software program, lower the baud rate to the computer, or change the handshaking protocol between the terminal and computer.*

How the computer will respond to a function key's code depends entirely on how the computer is programmed to respond to the transmitted codes.

The FUNCT Key

Not to be confused with the function keys described in the previous section, the FUNCT key transmits the ASCII code of the next alphanumeric key depressed, bracketed by SOH (start of header) and carriage return (CR) ASCII characters. (Refer to the ASCII Code Conversion Table in Appendix C.)

For example, if a word processing program requires the sequence **SOH C CR**, hold down the FUNCT key while pressing the C key. (The FUNCT key is similar to the SHIFT key.) But do not press a numeric key on the keypad or an editing key with the FUNCT key.

The communication mode in effect is irrelevant. The terminal only transmits the codes to the computer; it does not echo them to the screen.

NOTE! *You may need to program your computer's input/output string routine to catch the entire string and then process it. (If you are using an interrupt-driven computer, you do not need to worry about data being lost.)*

Tab Stops

Two types of tab stops are available:

Typewriter

Field

Typewriter tabs are recognized only when protect mode is off. Field tabs are recognized only when protect mode is on.

Set Tab Stops

Create column of typewriter tab stops at current cursor column (protect mode off); create column of field tab stops from cursor's current position downward (protect mode on)

ESC 1

NOTE! Be sure you enter a *number one*. A lowercase *L* turns on duplex edit mode.

Move the cursor to the desired column before executing the command.

When protect mode is off, this command establishes an invisible column of typewriter tab stops at the cursor's current column position.

When protect mode is on, this command creates a half-intensity, write-protected column extending down from the cursor's current position to the first protected position. All data within this column (i.e., below the original cursor position) is now write protected.



NOTE! As long as protect mode remains on, the visible cursor is excluded from this write-protected column. After protect mode is turned off, this column of half-intensity field tabs remains visible.

The cursor moves to the next unprotected column position (since it cannot remain in a protected area). The cursor column, starting at the cursor and extending down to the first write-protected position, contains field tab stops.

Each protected field created with the protected writing mode also automatically sets a field tab stop on the next unprotected character position. (This field tab stop does not extend downward.)

Table 4-11 summarizes the effect of the set tab command.

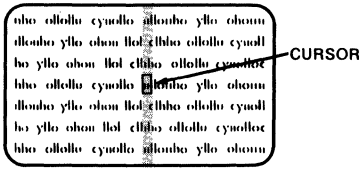
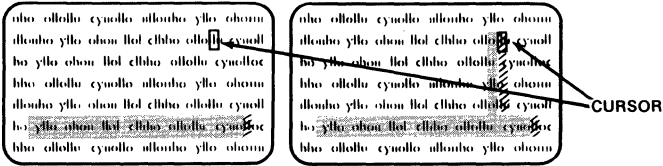
Table 4-11
Effect of ESC 1 (Set Tab Stop) Command

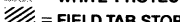
Mode		Effect
Autopage	Protect	
Off/On	Off	<p>Sets a column of typewriter tab stops on the cursor's current position.</p>  <p>INVISIBLE COLUMN OF TAB STOPS</p>
Off/On	On	<p>Creates a half-intensity, write-protected column from the cursor line down to the first write-protected position or end of page, whichever is first. Moves the cursor to the next column position and generates a column of field tab stops there down to the first write-protected position or end of page, whichever comes first.</p>  <p>BEFORE AFTER</p> <p>   = WRITE-PROTECTED POSITION  = FIELD TAB STOP </p>

Moving the Cursor to a Tab Stop	Move cursor forward to next typewriter tab stop (protect mode off); to	CTRL I
	next field tab stop (protect mode on)	
	Move cursor forward to next field tab stop (protect mode on)	ESC i
	Move cursor backward to previous field tab stop (protect mode on); to	ESC I
	previous typewriter tab stop (protect mode off)	

Protect mode affects all tabulation commands. CTRL I and ESC I move the cursor to a typewriter tab stop when protect mode is off, but to a field tab stop when it is on. When protect mode is off, ESC i has no effect. See Table 4-12.

Table 4-12
Summary of Tabulation Commands

Command	Cursor Movement	Protect Mode	Type of Tab Stop to Which Cursor Moves
CTRL I	Forward	Off	Typewriter
CTRL I	Forward	On	Field
ESC i	Forward	Off	None (has no effect)
ESC i	Forward	On	Field
ESC I	Backward	Off	Typewriter
		On	Field

Autopage mode also affects tabulation commands, as described in Tables 4-13 through 4-15.

Table 4-13
Effect of CTRL I (Forward Tabulation) Command on Cursor Position

Auto-page	Modes Protect	Auto-tab	Effect
Off/On	Off	Off	Moves the cursor to the next typewriter tab stop.

nbo oltello cyuolto allonbo ylo obom
 allonbo ylo obom lol ellho oltello cyuolt
 ho ylo obom lol ellho oltello cyuoltoc
 hho oltello cyuolto allonbo ylo obom
 allonbo ylo obom lol ellho oltello cyuolt
 ho ylo obom lol ellho oltello cyuoltoc
 hho oltello cyuolto allonbo ylo obom

nbo oltello cyuolto allonbo ylo obom
 allonbo ylo obom lol ellho oltello cyuolt
 ho ylo obom lol ellho oltello cyuoltoc
 hho oltello cyuolto allonbo ylo obom
 allonbo ylo obom lol ellho oltello cyuolt
 ho ylo obom lol ellho oltello cyuoltoc
 hho oltello cyuolto allonbo ylo obom

If no more tab stops exist, the cursor does not move.

On Moves the cursor to the first tab stop on the next line.

nbo oltello cyuolto allonbo ylo obom
 allonbo ylo obom lol ellho oltello cyuolt
 ho ylo obom lol ellho oltello cyuoltoc
 hho oltello cyuolto allonbo ylo obom
 allonbo ylo obom lol ellho oltello cyuolt
 ho ylo obom lol ellho oltello cyuoltoc
 hho oltello cyuolto allonbo ylo obom

nbo oltello cyuolto allonbo ylo obom
 allonbo ylo obom lol ellho oltello cyuolt
 ho ylo obom lol ellho oltello cyuoltoc
 hho oltello cyuolto allonbo ylo obom
 allonbo ylo obom lol ellho oltello cyuolt
 ho ylo obom lol ellho oltello cyuoltoc
 hho oltello cyuolto allonbo ylo obom

Table 4-13
Continued

Auto-page	Modes Protect	Auto-tab	Effect
Off	On	On/ Off	<p>Moves the cursor to the first position in the next unprotected field (i.e., next field tab stop).</p>  <p>The diagram illustrates the effect of the command when the cursor is in a protected field. It shows two states: 'BEFORE' and 'AFTER'. In the 'BEFORE' state, the cursor is positioned in a protected field (indicated by a shaded box). In the 'AFTER' state, the cursor has moved to the first unprotected field in the next field tab stop (indicated by a shaded box). A legend below the diagram shows a diagonal line symbol representing a 'FIELD TAB STOP'.</p>
			<p>If the current page has no more unprotected fields, the cursor moves up to the first unprotected position on that page.</p>  <p>The diagram illustrates the effect of the command when the current page has no more unprotected fields. It shows two states: 'BEFORE' and 'AFTER'. In the 'BEFORE' state, the cursor is positioned in a protected field (indicated by a shaded box). In the 'AFTER' state, the cursor has moved up to the first unprotected position on that page (indicated by a shaded box). A legend below the diagram shows a diagonal line symbol representing a 'FIELD TAB STOP'.</p>

Table 4-14
Effect of ESC i Command on Cursor Position

Auto-page	Modes Protect	Auto-tab	Effect
On	On	Off	<p>Moves the cursor to the next field tab stop (i.e., first unprotected position after next protected field).</p>  <p>The diagram illustrates the effect of the ESC i command when the cursor is in a protected field. It shows two states: 'BEFORE' and 'AFTER'. In the 'BEFORE' state, the cursor is positioned in a protected field (indicated by a shaded box). In the 'AFTER' state, the cursor has moved to the next field tab stop (i.e., first unprotected position after next protected field) (indicated by a shaded box). A legend below the diagram shows a diagonal line symbol representing a 'FIELD TAB STOP'.</p>

Table 4-14
Continued

Auto-page	Modes Protect	Auto-tab	Effect
On	On	Off	If no more unprotected fields exist on that page, the cursor advances to the first unprotected position on the next page.

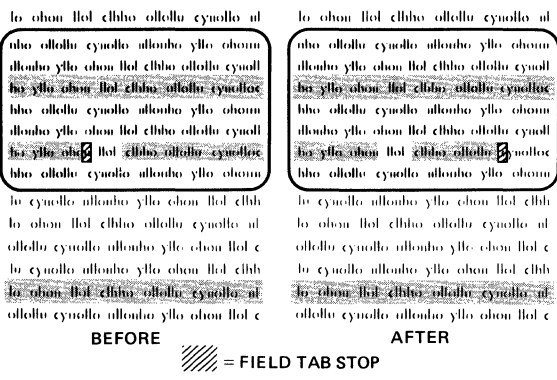
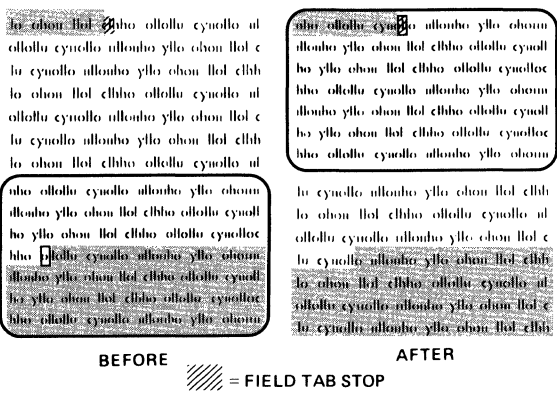

PAGE 1

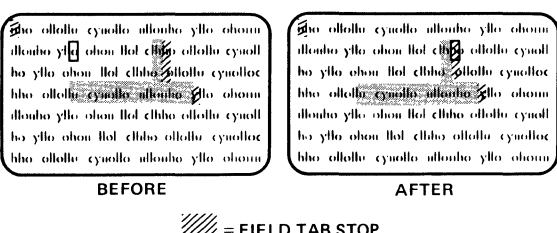
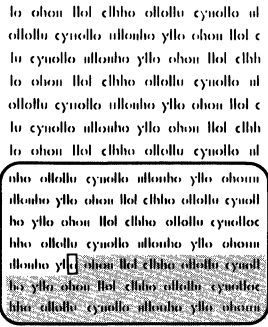
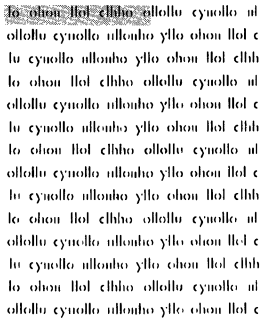

PAGE 2

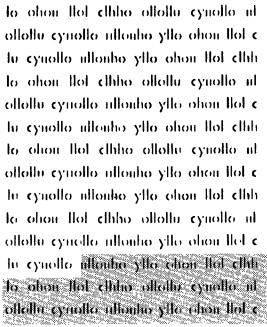

PAGE 1

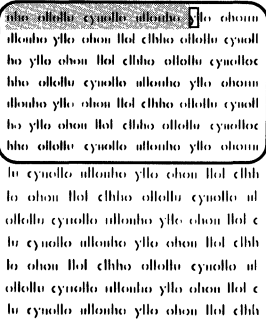

PAGE 2

BEFORE **AFTER**

If the next page is completely write protected, the terminal turns off protect mode and moves the cursor to home position on next page.

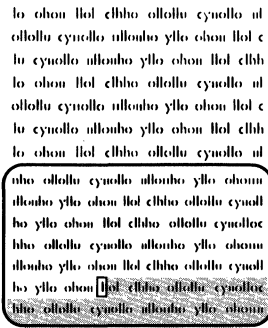
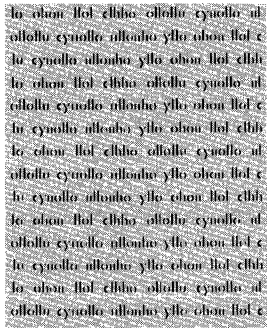
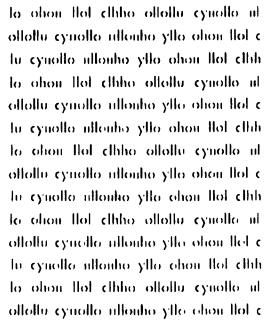
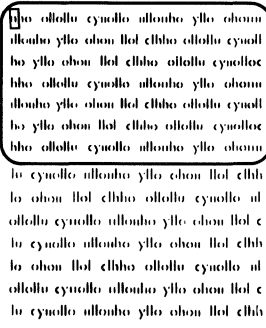
 <p>PAGE 1</p>	 <p>PAGE 2</p>	 <p>PAGE 1</p>	 <p>PAGE 2</p>
--	--	---	--

BEFORE **AFTER**

Table 4-15
Effect of ESC I (Back Tab) Command on Cursor Position

Auto-page	Modes Protect	Auto-tab	Effect
Off/ On	Off	Off/ On	Moves the cursor back to the previous typewriter tab stop.



BEFORE



AFTER

Table 4-15
Continued

Modes			Effect
Auto-page	Protect	Auto-tab	
Off/ On	Off	Off	Has no effect if the cursor is already on the line's first tab position or if no other tabs are set.

aho allah cyuollo allonho ylo ohom
 allonho ylo ohom lol elhho allallo cyuoll
 ho ylo ohom lol elhho allallo cyuoll
 hho allallo cyuollo allonho ylo ohom
 allonho ylo ohom lol elhho allallo cyuoll
 ho ylo ohom lol elhho allallo cyuoll
 hho allallo cyuollo allonho ylo ohom

OR

aho allallo cyuollo allonho ylo ohom
 allonho ylo ohom lol elhho allallo cyuoll
 ho ylo ohom lol elhho allallo cyuoll
 hho allallo cyuollo allonho ylo ohom
 allonho ylo ohom lol elhho allallo cyuoll
 ho ylo ohom lol elhho allallo cyuoll
 hho allallo cyuollo allonho ylo ohom

On If the cursor is already on the line's first tab position or no other tab stops exist between the cursor and the line's first position, the cursor moves to the previous line's last tab position.

aho allallo cyuollo allonho ylo ohom
 allonho ylo ohom lol elhho allallo cyuoll
 ho ylo ohom lol elhho allallo cyuoll
 hho allallo cyuollo allonho ylo ohom
 allonho ylo ohom lol elhho allallo cyuoll
 ho ylo ohom lol elhho allallo cyuoll
 hho allallo cyuollo allonho ylo ohom

OR

aho allallo cyuollo allonho ylo ohom
 allonho ylo ohom lol elhho allallo cyuoll
 ho ylo ohom lol elhho allallo cyuoll
 hho allallo cyuollo allonho ylo ohom
 allonho ylo ohom lol elhho allallo cyuoll
 ho ylo ohom lol elhho allallo cyuoll
 hho allallo cyuollo allonho ylo ohom

aho allallo cyuollo allonho ylo ohom
 allonho ylo ohom lol elhho allallo cyuoll
 ho ylo ohom lol elhho allallo cyuoll
 hho allallo cyuollo allonho ylo ohom
 allonho ylo ohom lol elhho allallo cyuoll
 ho ylo ohom lol elhho allallo cyuoll
 hho allallo cyuollo allonho ylo ohom

BEFORE

AFTER

Off	On	Off/ On	Moves the cursor back to the first position in the current unprotected field. Another back tab command moves the cursor back to the beginning of the previous unprotected field.
-----	----	------------	--

aho allallo cyuollo allonho ylo ohom
 allonho ylo ohom lol elhho allallo cyuoll
 ho ylo ohom lol elhho allallo cyuoll
 hho allallo cyuollo allonho ylo ohom
 allonho ylo ohom lol elhho allallo cyuoll
 ho ylo ohom lol elhho allallo cyuoll
 hho allallo cyuollo allonho ylo ohom

aho allallo cyuollo allonho ylo ohom
 allonho ylo ohom lol elhho allallo cyuoll
 ho ylo ohom lol elhho allallo cyuoll
 hho allallo cyuollo allonho ylo ohom
 allonho ylo ohom lol elhho allallo cyuoll
 ho ylo ohom lol elhho allallo cyuoll
 hho allallo cyuollo allonho ylo ohom

aho allallo cyuollo allonho ylo ohom
 allonho ylo ohom lol elhho allallo cyuoll
 ho ylo ohom lol elhho allallo cyuoll
 hho allallo cyuollo allonho ylo ohom
 allonho ylo ohom lol elhho allallo cyuoll
 ho ylo ohom lol elhho allallo cyuoll
 hho allallo cyuollo allonho ylo ohom

/// = FIELD TAB STOP

If the page contains no previous unprotected positions, the cursor does not move.

aho allallo cyuollo allonho ylo ohom
 allonho ylo ohom lol elhho allallo cyuoll
 ho ylo ohom lol elhho allallo cyuoll
 hho allallo cyuollo allonho ylo ohom
 allonho ylo ohom lol elhho allallo cyuoll
 ho ylo ohom lol elhho allallo cyuoll
 hho allallo cyuollo allonho ylo ohom

aho allallo cyuollo allonho ylo ohom
 allonho ylo ohom lol elhho allallo cyuoll
 ho ylo ohom lol elhho allallo cyuoll
 hho allallo cyuollo allonho ylo ohom
 allonho ylo ohom lol elhho allallo cyuoll
 ho ylo ohom lol elhho allallo cyuoll
 hho allallo cyuollo allonho ylo ohom

BEFORE AND AFTER

/// = FIELD TAB STOP

Table 4-15
Continued

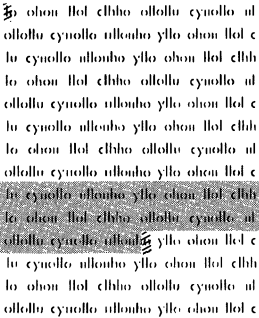
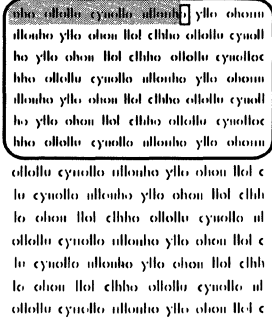
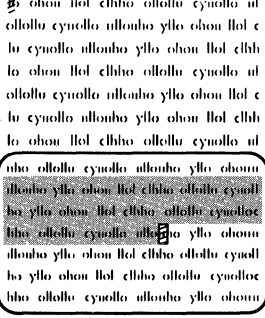
Modes		Auto-tab	Effect
Auto-page	Protect		
On	On	Off/On	If the cursor is on the page's first unprotected position, it moves to the first character in the previous page's last unprotected field.
 <p>PAGE 1</p>		 <p>PAGE 2</p>	 <p>PAGE 1</p>
		BEFORE	AFTER
= FIELD TAB STOP			

If no unprotected fields exist there, turns off protect mode and moves the cursor to home on that page.

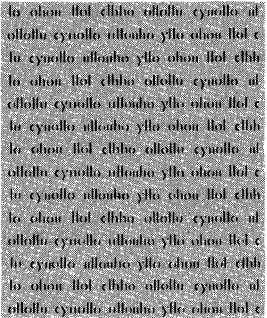
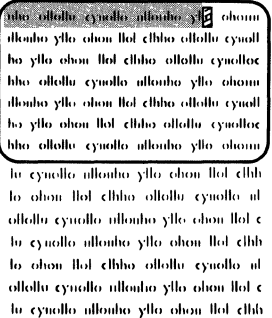
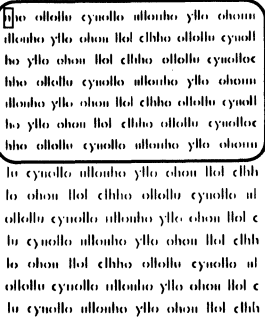
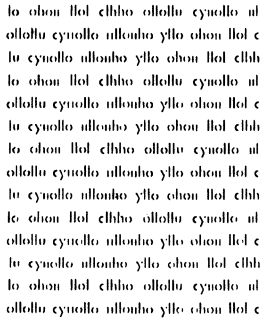
 <p>PAGE 1</p>		 <p>PAGE 2</p>	 <p>PAGE 1</p>	 <p>PAGE 2</p>
		BEFORE	AFTER	
= FIELD TAB STOP				

If the cursor is on the first page's first unprotected position, this code has no effect.

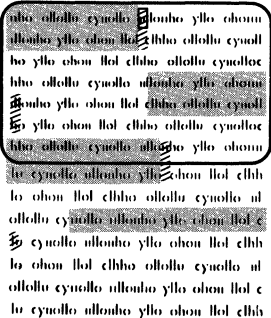
 <p>PAGE 1</p>	
BEFORE and AFTER	
= FIELD TAB STOP	

Clearing a Typewriter Tab Stop(s)

Clear typewriter tab stop at cursor location ESC 2
 Clear all typewriter tab stops¹ ESC 3

1. The position of the cursor when the terminal receives this code is irrelevant.

NOTE! *Protect mode does not affect commands to clear a typewriter tab stop.*

Clearing a Field Tab Stop

You can not clear field tab stops with a command. They are all automatically disabled when you turn protect mode off and restored when you turn it on again.

Communication Modes

	SET UP/STATUS
Block mode on	ESC B
Half duplex mode on	ESC D H
Full duplex mode on	ESC D F
Return to previous conversational mode (half or full duplex) from block mode ¹	ESC C

1. For example, the terminal was in full duplex before you changed it to block duplex. To return to full duplex, enter either ESC C (conversational) or ESC D F (full duplex).

You can control communication between the terminal and the computer by entering these escape sequences or by changing the status or set up lines. Three modes are possible:

- Block
- Half duplex (conversational)
- Full duplex (conversational)

Edit Modes

	SET UP
Activate local edit mode	ESC k 1
Activate duplex edit mode	ESC k 0

Edit modes determine whether changes made with the editing keys are sent to the computer (called **duplex edit**) or to the terminal (**local edit**). In duplex edit mode, the codes from the editing keys are transmitted as though they came from an alphanumeric key. In local edit mode, the editing keys do not send a code to the computer.

Local edit mode lets you change text without transmitting the changes or the commands to the computer (i.e., all changes affect the displayed text but not anything in the computer). The following keys do not send codes to the computer during local edit mode:

- | | |
|--|---|
| <ul style="list-style-type: none"> ↑ ↓ → ← BACK TAB CHAR DELETE CHAR INSERT CE (CLEAR ENTRY) CLEAR SPACE ENTER | <ul style="list-style-type: none"> HOME LINE DELETE LINE ERASE LINE INSERT PAGE PAGE ERASE PRINT SEND TAB (both) |
|--|---|

During local edit mode, all other keys operate normally.

During duplex edit mode, the codes generated by the editing keys named above are treated like alphanumeric keys. Thus the communication mode, half or full duplex, determines where the codes are sent.

For example, during half duplex mode, both the alphanumeric and editing keys operate in half duplex mode.

Changing Data

You can change data in five ways:

Write over existing text¹

Erase existing text (leaving space or null characters in its place)

Delete a character, line, or page of existing text

Insert space characters

Clear data (not dependent on cursor position)

1. No special command is needed to write over existing text.

Edit Boundary Modes

Page edit mode on	SET UP
Line edit mode on	ESC N 1
	ESC N 0

Edit boundary modes determine whether insert and delete commands (described next) affect the current cursor line or the current page. If you try to move data beyond the boundary established by the current edit mode, it can be lost as it "falls off" the edge.

NOTE! *The terminal is always in either page or line edit mode.*

Page Edit Mode—As you insert characters during page edit mode, the existing text moves down to the next line as necessary. The "page" length is determined by the number of lines of memory for that page. For example, if you installed extra memory and configured the memory for one 96-line page, the text (of which you can see 24 lines at a time) can flow forward within that 96-line area. However, when the text being pushed forward by the inserted spaces moves beyond column 80 of the page's last line, it is lost.

When you delete characters in page edit mode, the character in column one of any line moves to column 80 of the previous line (i.e., backward wraparound).

During page edit mode, the insert and delete codes can only affect the current unprotected area.

NOTE! *This allows you to limit editing fields by inserting a protected character anywhere in the screen. Insert and delete codes can only affect the area above that protected character.*

The status line contains **PAGE** during page edit mode.

Line Edit Mode—Line edit mode limits the effect of character insert or delete commands to the current cursor line. Characters move forward or backward until they reach either column one or column 80. Text can be lost (i.e., "fall off") either end of the line being edited.

The status line contains **LINE** during line edit mode.

Editing Commands

Insert a space character at cursor position	ESC Q
Delete character at cursor position	ESC W
Insert a line of space characters on current line	ESC E
Delete current line of data	ESC R
Erase characters to end of line and replace with space characters	ESC T
Erase characters to end of line and replace with null characters	ESC t
Erase characters to end of page and replace with space characters	ESC Y
Erase characters to end of page and replace with null characters	ESC y

Erase and delete commands remove only unprotected characters. If both write protect and protect modes are on when an erase line or erase page command is received, the command is ignored.

Line insert and delete commands are illegal while protect mode is on; they ring the bell.

Both edit and protect modes affect the action of character insert and delete commands, as described in Table 4-16. Table 4-17 describes the other editing commands, including their action during protect mode.

NOTE! All of these commands are affected by a defined scrolling region. In the following table, it is assumed that the scrolling region is defined as the entire screen.

Table 4-16
Effect of Edit and Protect Modes on Character Insert and Delete Commands

Command	Modes		Effect
	Edit	Protect	
Insert character	Page	Off	<p>Enters a space character in the current visual attribute at the cursor position and moves the characters right one column, starting at the cursor. The character at column 80 wraps to column one of next line, regardless of autowrap mode. Data pushed past last position on page is lost.</p> <p style="text-align: center;">BEFORE AFTER</p>
		On	<p>Same as protect mode off except moves only unprotected characters in current field. Characters reaching the first protected position are lost.</p> <p style="text-align: center;">BEFORE AFTER</p>

Table 4-16
Continued

Command	Modes		Effect
	Edit	Protect	
Insert character	Line	Off	<p>Enters a space character in the current visual attribute at the cursor's position; moves the cursor character right one position. Data pushed past column 80 is lost.</p> <p>BEFORE AAAAAAAAAAAAAAAAAAAAAA AAAAAAAAA </p> <p>AFTER AAAAAAAAAAAAAAAAAAAAAA A AAAAAAAAA A ← LOST</p> <p style="text-align: center;">↑ SPACE CHARACTER</p>
		On	<p>Same as protect off except data is lost when it reaches a protected position or end of line.</p> <p>BEFORE P P P P A B C E F P P P P G H I J K L M N O P Q R </p> <p>AFTER P P P P A B C D E P P P P </p> <p style="text-align: center;">↑ ↙ SPACE CHARACTER LOST</p>
Delete character	Line	Off	<p>Deletes the cursor character; pulls following characters left one position. Adds a space character in the current visual attribute at column 80.</p> <p>BEFORE A B C D E F G H I J K L M N O P Q R S T U V W X Y Z A B C </p> <p>AFTER A B C D E F G H I J K L M N O P Q R S T U V W X Y Z A B C . </p> <p style="text-align: center;">↑ SPACE CHARACTER</p>
		On	<p>Same as unprotected except deletes only unprotected characters within the cursor's field. Adds a space character in the current visual attribute at the end of that field.</p> <p>BEFORE P P P P A B C D E G H P P P I J K L M N O P Q R S </p> <p>AFTER P P P P A B C D E H P P P I J K L M N O P Q R S </p> <p style="text-align: center;">↑ SPACE CHARACTER</p>

**Table 4-16
Continued**

Command	Modes		Effect
	Edit	Protect	
Delete character	Page	Off	<p>Deletes the cursor character; pulls following characters left one position. Moves the first character of any following line to the last position in the current line. Adds a space character in the current visual attribute at the page's last position.</p> <div style="display: flex; justify-content: space-around;"> <div style="border: 1px solid black; padding: 5px; width: 45%;"> <p>lo obou lol elhho ollollu cyuollo ul ollollu cyuollo ullouho ylllo obou lol e lu cyuollo ullouho ylllo obou lol elhho lo obou lol elhho ollollu cyuollo ul ollollu cyuollo ullouho ylllo obou lol e lu cyuollo ullouho ylllo obou lol elhho lo obou lol elhho ollollu cyuollo ul</p> <p>oho ollollu cyuollo ullouho ylllo obou ullouho ylllo obou lol elhho ollollu cyuoll ho ylllo obou lol elhho ollollu cyuoll hho ollollu cyuollo ullouho ylllo obou ullouho ylllo obou lol elhho ollollu cyuoll ABCDEFGHIJKLMNORSTUVWXYZ ABCDEFGHIJKLMNORSTUVWXYZ</p> <p style="text-align: center;">BEFORE</p> </div> <div style="border: 1px solid black; padding: 5px; width: 45%;"> <p>lo obou lol elhho ollollu cyuollo ul ollollu cyuollo ullouho ylllo obou lol e lu cyuollo ullouho ylllo obou lol elhho lo obou lol elhho ollollu cyuollo ul ollollu cyuollo ullouho ylllo obou lol e lu cyuollo ullouho ylllo obou lol elhho lo obou lol elhho ollollu cyuollo ul</p> <p>oho ollollu cyuollo ullouho ylllo obou ullouho ylllo obou lol elhho ollollu cyuoll ho ylllo obou lol elhho ollollu cyuoll hho ollollu cyuollo ullouho ylllo obou ullouho ylllo obou lol elhho ollollu cyuoll ABCDEFGHIJKLMNORSTUVWXYZA BCDEFGHIJKLMNORSTUVWXYZ</p> <p style="text-align: center;">AFTER</p> </div> </div> <p style="text-align: right; margin-right: 20px;">SPACE CHARACTER</p>
		On	<p>Same as protect mode off except deletes cursor character and adds a space character in the current visual attribute at end of that field.</p> <div style="display: flex; justify-content: space-around;"> <div style="border: 1px solid black; padding: 5px; width: 45%;"> <p>oho ollollu cyuollo ullouho ylllo obou ullouho ylllo obou lol elhho ollollu cyuoll ho ylllo obou lol elhho ollollu cyuoll hho ollollu cyuollo ullouho ylllo obou ullouho ylllo obou lol elhho ollollu cyuoll ho ylllo obou lol elhho ollollu cyuoll hho ollollu cyuollo ullouho ylllo obou</p> <p style="text-align: center;">BEFORE</p> </div> <div style="border: 1px solid black; padding: 5px; width: 45%;"> <p>oho ollollu cyuollo ullouho ylllo obou ullouho ylllo obou lol elhho ollollu cyuoll ho ylllo obou lol elhho ollollu cyuoll hho ollollu cyuollo ullouho ylllo obou ullouho ylllo obou lol elhho ollollu cyuoll ho ylllo obou lol elhho ollollu cyuoll hho ollollu cyuollo ullouho ylllo obou</p> <p style="text-align: center;">AFTER</p> </div> </div> <p style="text-align: right; margin-right: 20px;">SPACE CHARACTER</p>

**Table 4-17
Effect of Protect Mode on Other Editing Commands**

Command	Protect Mode	Effect
	On	Does not delete line but rings bell.

**Table 4-17
Continued**

Command	Protect Mode	Effect
Insert line	Off	<p>Inserts a line of space characters in the current visual attribute on the current line and moves all lines below it down one line. Moves the cursor to the new line's first position. The page's last line is lost.</p>
	On	Does not insert a line but rings bell.
Erase to end of line with spaces	Off	<p>Replaces all characters from cursor through column 80 with space characters in the current visual attribute.</p>
	On	<p>Same as protect off except erases unprotected data starting at the cursor and extending through the current field or end of current line, whichever comes first.</p>
Erase to end of line with nulls	Off	<p>Replaces all characters from the cursor through column 80 with null characters in the current visual attribute.</p>
	On	Ignored if write protect and protect modes are both on.

Table 4-17
Continued

Command	Protect Mode	Effect
---------	--------------	--------

Erase to end of line with nulls	On	Same as protect off except erases unprotected data starting at the cursor and extending through the current field or end of current line, whichever comes first.
---------------------------------	----	--

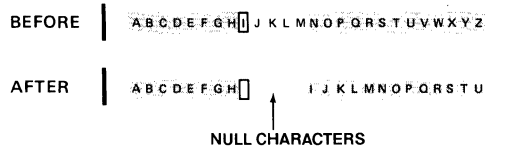

Ignored if write protect and protect modes are both on.

Erase to end of page with spaces	Off	Replaces characters from the cursor through the end of the page with space characters in the current visual attribute.
----------------------------------	-----	--

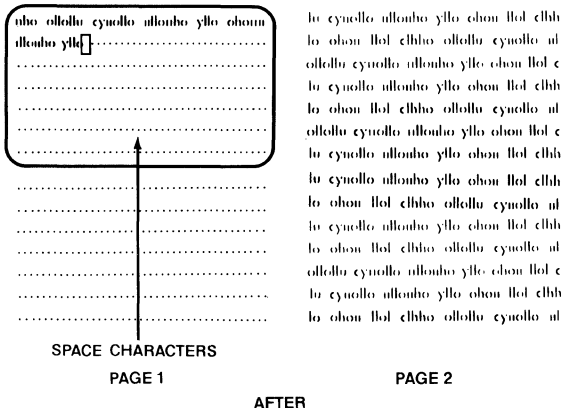
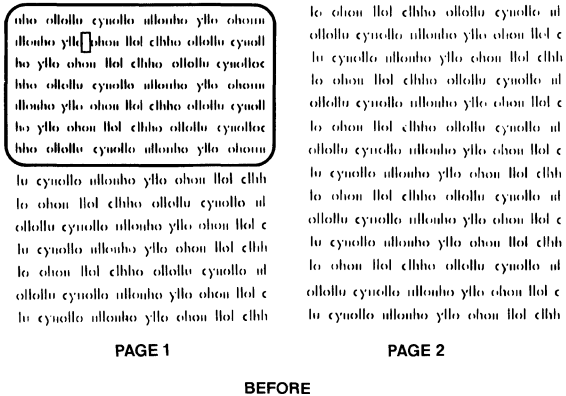

Table 4-17
Continued

Command	Protect Mode	Effect
Erase to end of page with spaces	On	Same as protect mode off except erases unprotected data starting at the cursor and extending through the current field or end of current page, whichever comes first. Ignored if write protect and protect modes are both on.
Erase to end of page with nulls	Off	Replaces characters from the cursor through the end of the page with null characters in current visual attribute.
Erase to end of page with spaces	On	Same as protect off except erases unprotected data starting at the cursor and extending through the current field or end of current page, whichever comes first. Ignored if write protect and protect modes are both on.

Clearing Data from Memory

- Clear all characters and replace with null characters ESC * 0
- Clear all characters and replace with space characters ESC * 1
- Clear unprotected characters and replace with null characters ESC * 2
- Clear unprotected characters and replace with space characters ESC * 3
- or CTRL Z
- CTRL X

Clear current unprotected field and replace with space characters. Return cursor to last unprotected position (protect mode on) or else clear current tab field or whole line and move cursor to beginning of current tab field or line (protect mode off)

Clear commands remove data from the screen's current page of memory and replace it with either space or null characters. The cursor moves to the home position (or, if protect mode is on, to the page's first unprotected position). Unlike insert and delete commands, the area affected by clear commands does not depend on the cursor position.

NOTE! If both write protect and protect modes are on, any command to clear unprotected data to either nulls or spaces is ignored. Refer to Table 4-18.

Table 4-18
Clear Commands

Command	Effect
<p>Clear all to nulls</p> <p>Changes all data on the current page to null characters with normal visual attribute. Clears all previous visual attributes. Moves the cursor to home position. Turns off protect, logical attribute, and write protect modes, if on. (The cursor's initial position is irrelevant.)</p>	<p>NULL CHARACTERS</p> 
<p>Clear all to spaces</p> <p>Changes all data on the current page to space characters with normal visual attribute. Clears all previous visual attributes. Moves the cursor to home position. Turns off protect, logical attribute, and write protect modes, if on. (The cursor's initial position is irrelevant.)</p>	<p>SPACE CHARACTERS</p> 

Table 4-18
Continued

Command **Effect**

Clear all unprotected to nulls Changes all unprotected data on the current page to null characters with current visual attribute. Moves the cursor to the page's first unprotected position. (The cursor's initial position is irrelevant.)

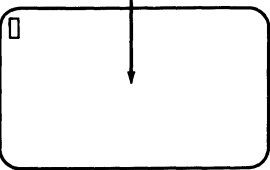
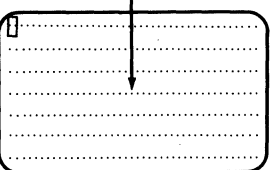
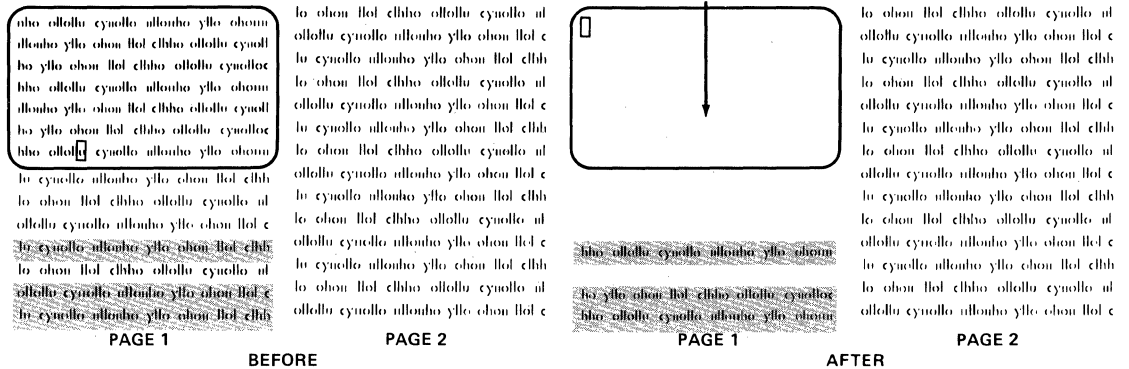

If protect and write protect modes are on, the bell rings (no data is cleared).

Clear all unprotected to spaces Changes all unprotected data on the current page to space characters with current visual attribute. Moves the cursor to the page's first unprotected position. (The cursor's initial position is irrelevant.)

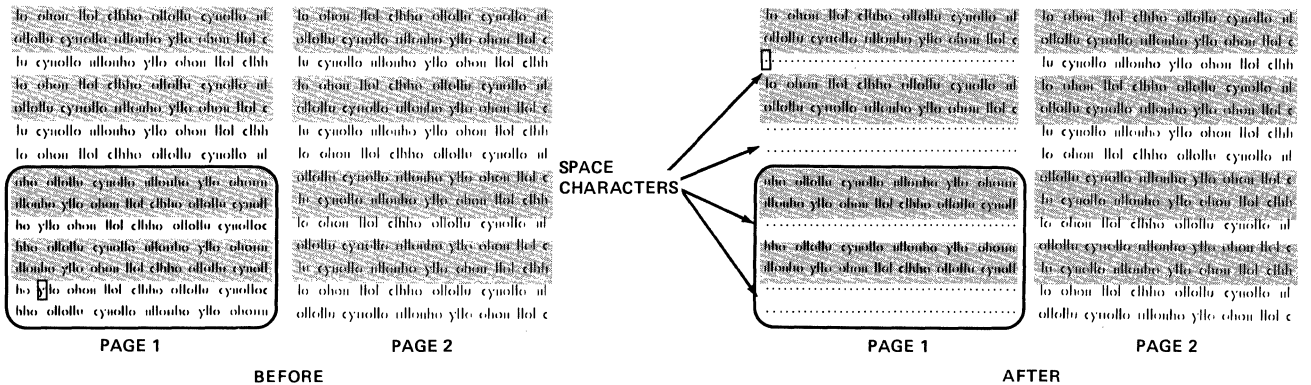

If protect and write protect modes are on, the bell rings (no data is cleared).

Clear unprotected field to spaces If protect mode is on, replaces all characters in the current unprotected field with space characters and moves the cursor to the first position in the current unprotected field.

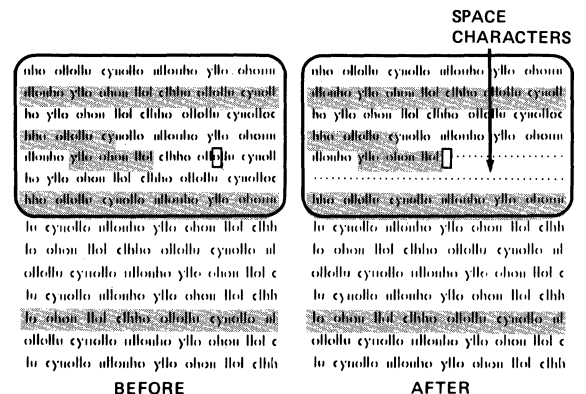

If write protect and protect modes are both on, has no effect.

**Table 4-18
Continued**

Command	Effect
---------	--------

Clear field to spaces If protect mode is off and typewriter tab stops are set, clears all characters between the typewriter tab stops surrounding the cursor to space characters and moves the cursor to beginning of that field.



If no typewriter tab stops exist, replaces the current line with space characters and returns the cursor to the beginning of the current line.

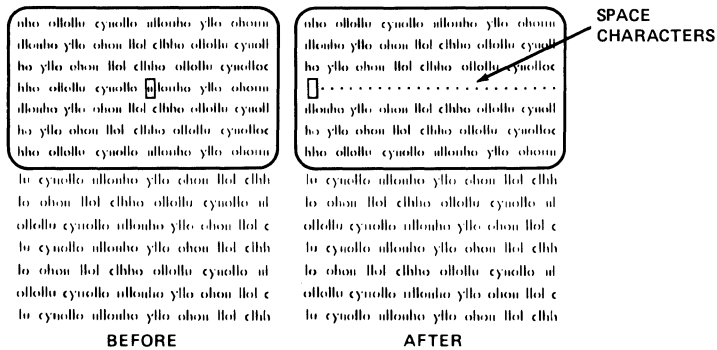

Selecting a Handshaking Protocol

Disable X-On/X-Off and enable DTR line
Enable X-On/X-Off and disable DTR line

SET UP
CTRL N
CTRL O

Both X-On/X-Off and Data Terminal Ready (DTR) are available for the handshaking protocol between the terminal and the computer. Handshaking prevents data loss when a printer is connected to the terminal and data is received from the computer faster than the printer can print it or when smooth scroll mode is on.

X-On/X-Off

The terminal's 256-character receive buffer holds data received through the computer port. When this buffer has room for fewer than 32 characters, the terminal transmits X-Off to the computer, asking it to stop sending data. When only 16 characters remain in the receive buffer after the screen has been updated, the terminal sends the computer an X-On character (telling it to resume data transmission to the terminal).

If the terminal receives X-Off from the computer, all data transmission to the computer stops until the terminal receives X-On from the computer.

While X-On/X-Off is enabled, voltage on the DTR line remains high.

Data Terminal Ready The DTR line is activated whenever X-On/X-Off is disabled. This allows the voltage on the DTR line to drop when the terminal's 256-character receive buffer (from the computer port) receives 224 bytes from the computer. When only 16 characters remain in the receive buffer, the voltage on the DTR line is raised, indicating that the computer may resume sending data to the terminal.

Transmitting Data During full or half duplex mode, data entered on the keyboard immediately goes to the computer. But during block mode, sending it to the computer is a separate step. You can either press the preprogrammed shifted/unshifted SEND key (described in Chapter 5) or enter an escape sequence to send specific data (described below).

You can define how much data some send commands will send by inserting markers in the text. Use a start of text (STX) ASCII character to mark where you want data transmission to begin and an end of text (ETX) ASCII character to mark where you want it to stop. You can insert them while the terminal is in monitor mode or you can include ESC CTRL B (for STX) or ESC CTRL C (for ETX).

NOTE! *Since STX and ETX are ASCII characters, they occupy a character position.*

Some transmission commands cause the terminal to automatically include delimiters to indicate the beginning or end of a field, the end of a line, or the end of the transmission.

Unless these delimiters are reprogrammed (as described in Chapter 5), the terminal sends an FS character as a field separator, a US character after each line, and a CR character after each transmission.

Sending Data Define data to be sent ESC S n
where

n is the value for the amount and type of data to be sent.

n Value	Amount Sent
1	Unprotected characters (except special graphics characters) in cursor line up to and including cursor
2	Protected characters (except special graphics characters) in cursor line up to and including cursor
3	Entire line of data (except special graphics characters) up to and including cursor
5	Unprotected page of data (except special graphics characters) up to and including cursor
6	Protected page of data (except special graphics characters) up to and including cursor
7	Entire page of data (except special graphics characters) up to and including cursor
9	Unprotected message (except special graphics characters) between start of text (STX) ¹ and end of text (ETX) ²
:	Protected message (except special graphics characters) between start of text (STX) ¹ and end of text (ETX) ²
;	Entire message (except special graphics characters) between start of text (STX) ¹ and end of text (ETX) ²
?	Form (home through end of page, regardless of cursor position) ³

1. If no STX character is present, sends starting at home position.
2. If no ETX character is present, sends through end of page.
3. Includes ESC G n for start of visual attribute, ESC \$ and ESC % for graphics character fields, and ESC) and ESC (for any write-protected fields.

Send commands have no effect when protect mode is on.

Unless STX and ETX characters are visible they are ignored.

Nulls in the delimiters are not sent.

If the data contains more than one set of STX and ETX characters, only the STX character that is above and nearest the cursor and the ETX character following this STX character have any effect on the data transmission.

You can define the quantity and type of data sent to the computer in block mode with this command (Table 4-19).

Table 4-19
Send Commands

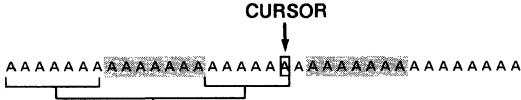
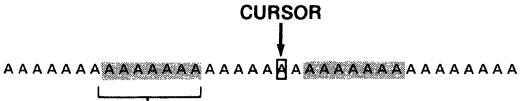
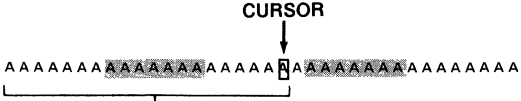
Command	Effect
Send unprotected line	<p>Unprotected line to cursor—Sends all unprotected data on the line between and including column one and the cursor.</p>  <p>Delimiters¹—Sends a field separator for each protected field and a termination character after the transmission.²</p>
Send protected line	<p>Protected line to cursor—Sends only protected data, starting at column one through the cursor position.</p>  <p>Delimiters¹—Sends a field separator for each unprotected field and a termination character after the transmission.²</p>
Send line	<p>Entire line to and including cursor—Sends all data between (and including) home and cursor positions.</p>  <p>Delimiters¹—Sends a termination character after the transmission.²</p>

1. Default delimiters are given in the next section.
 2. Transmission does not include any video attributes or the status of special graphics and write protect modes.

**Table 4-19
Continued**

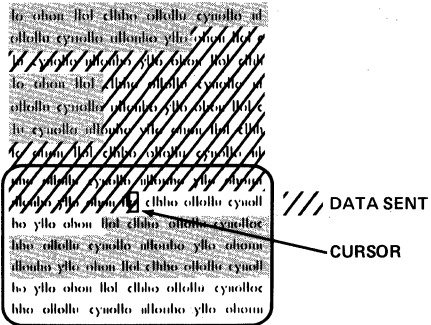
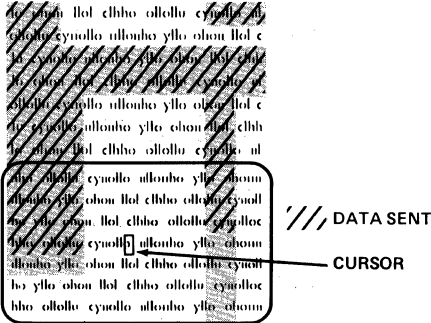
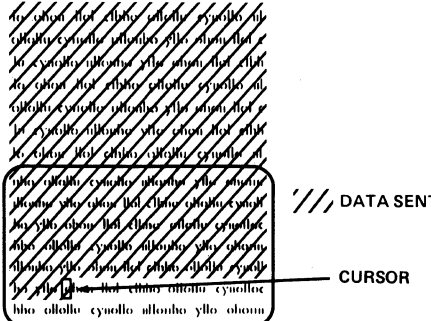
Command	Effect
Send unprotected page	<p>Unprotected page to and including cursor—Sends only unprotected data between and including the page's first unprotected position and the cursor position.</p> 
Send protected page	<p>Delimiters¹—Sends a field separator in place of each protected field, line delimiter after each line, and a termination character after the transmission.²</p> <p>Protected page to and including cursor—Sends only protected data at and including the page's first protected position and the cursor position.</p> 
Send page	<p>Delimiters¹—Sends a field separator in place of each protected field, line delimiter after each line, and a termination character after the transmission.²</p> <p>Entire page to and including cursor—Sends all data between and including home and cursor positions.</p>  <p>Delimiters¹—Sends line delimiter after each line and a termination character after the transmission.²</p>

1. Default delimiters are given in the next section.
2. Transmission does not include any video attributes or the status of special graphics and write protect modes.

Table 4-19
Continued

Command	Effect
Send unprotected message	Unprotected message (STX to ETX)—Sends all unprotected data located between either STX character (if cursor follows STX character) or first unprotected position (if the cursor is before STX character) and ETX character. Moves the cursor to ETX character position.

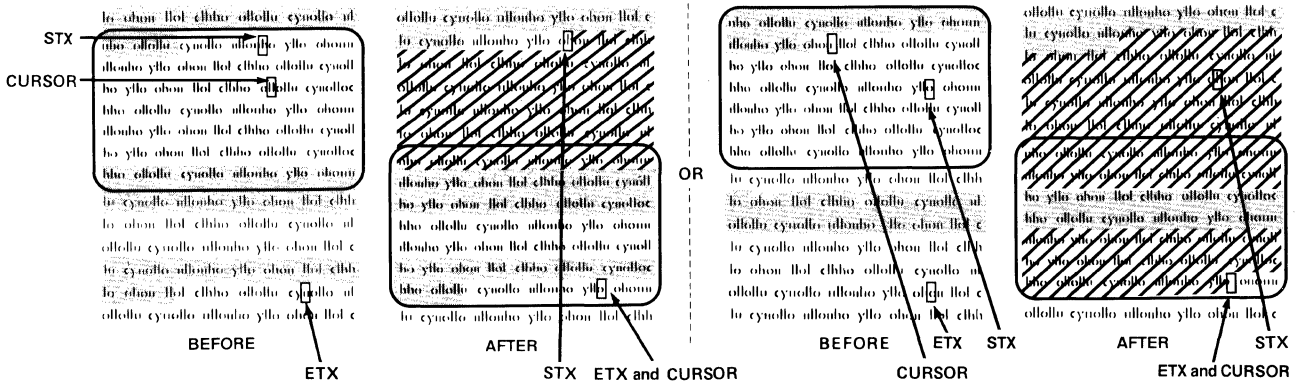

If the page lacks an STX character, sends all unprotected characters starting at first unprotected position and continuing until ETX character. Moves cursor to ETX character position.

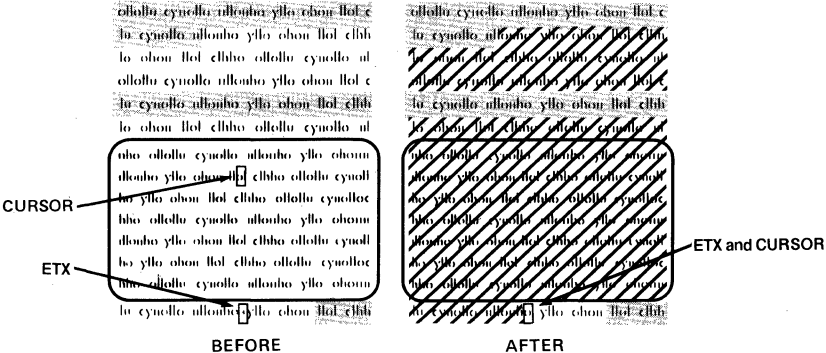

If the page lacks an ETX character, sends all unprotected data located between either the STX character (if cursor follows STX character) or the first unprotected position (if the cursor is before the STX character) and the end of the page. Moves the cursor to the page's first unprotected position.

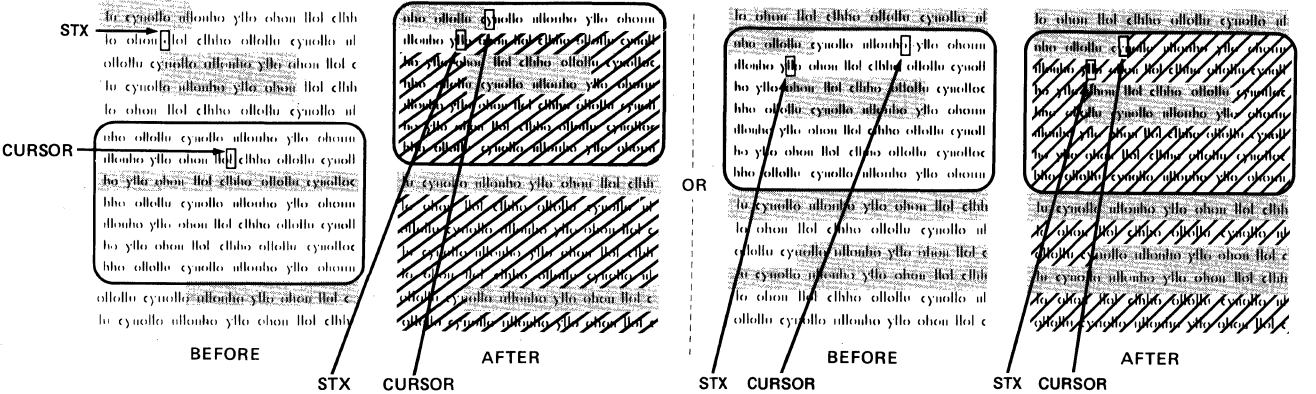
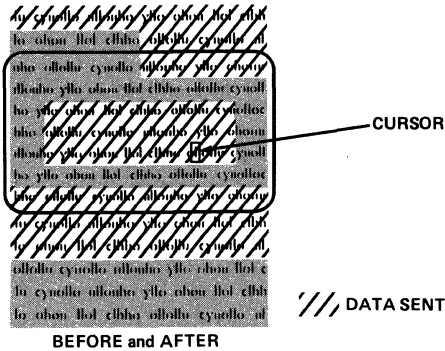

Table 4-19
Continued

Command	Effect
---------	--------

Send unprotected message

If the page has no STX or ETX characters, sends all unprotected data on the page.



Delimiters¹—Sends a field separator in place of each protected field, line delimiter after each line, and a termination character after the transmission.²

Send protected message

Protected message (STX to ETX)—Sends protected data between the STX and ETX characters. Moves the cursor to the ETX character.

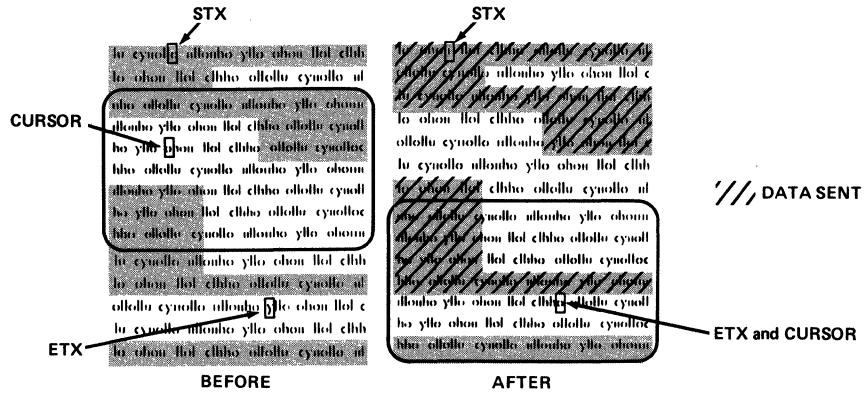

If no STX character is present, sends from the page's first protected position up to the ETX character. Moves the cursor to the ETX character.

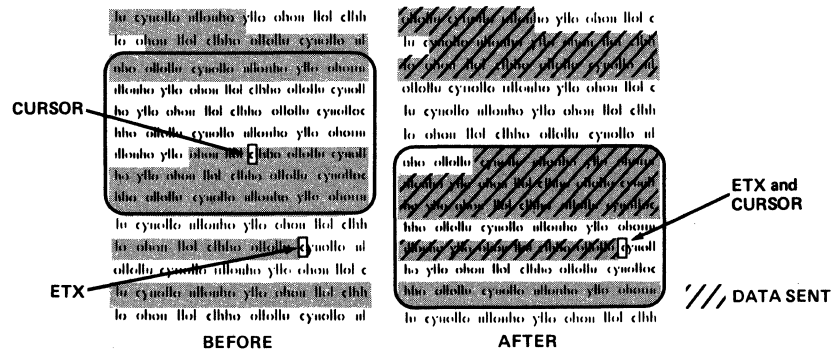

1. Default delimiters are given in the next section.
2. Transmission does not include any video attributes or the status of special graphics and write protect modes.

Table 4-19
Continued

Command **Effect**

Send protected message
If the page lacks an ETX character, sends all protected data located between the STX character and the cursor (if the cursor follows the STX character) or the first protected position and the cursor (if the cursor precedes the STX character). Moves the cursor to the page's first unprotected position.

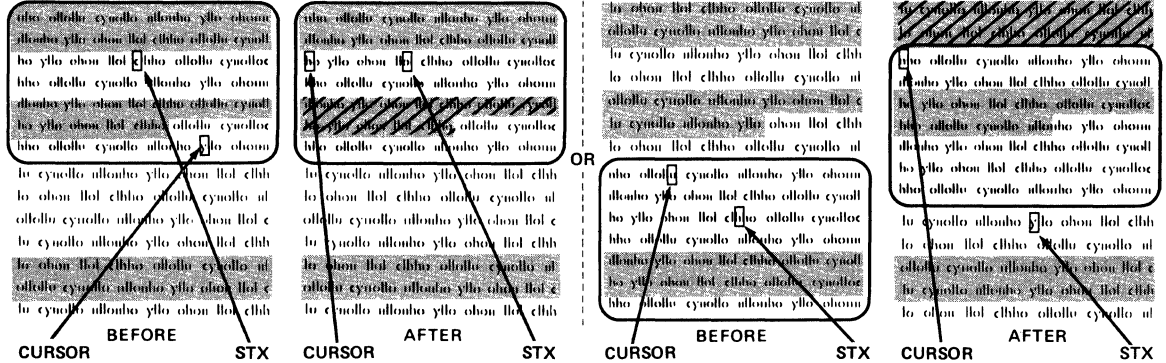

If the cursor is before STX character, sends protected data from the first protected position through the end of the page. Moves the cursor to the page's first unprotected position.

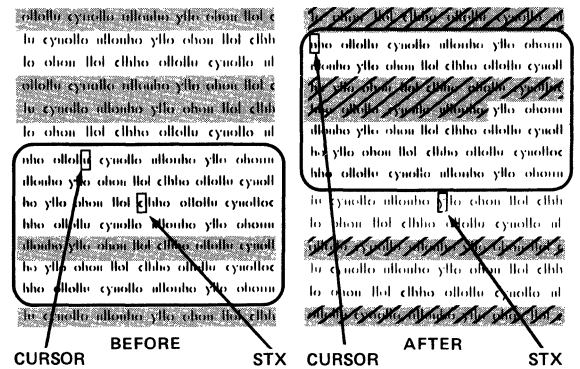

If the page lacks both STX and ETX characters, sends all protected data on the page. Moves the cursor to the page's first unprotected position.

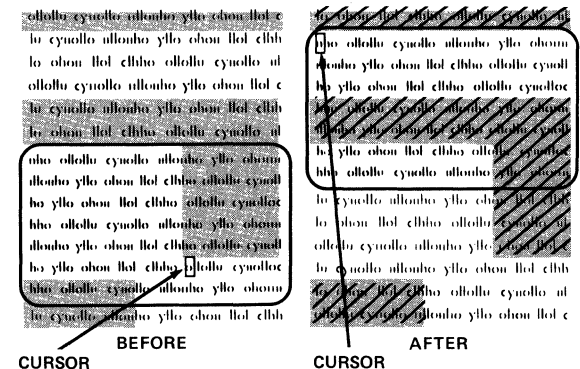

Table 4-19
Continued

Command

Effect

Send
entire
message

Delimiters¹—Sends field separator for each unprotected field, line delimiter after each line, and termination character after the transmission.²

Entire message (STX to ETX)—Sends all data located between either the STX character (if the cursor follows the STX character) or home (if the cursor is before the STX character) and the ETX character. Moves the cursor to the ETX character.

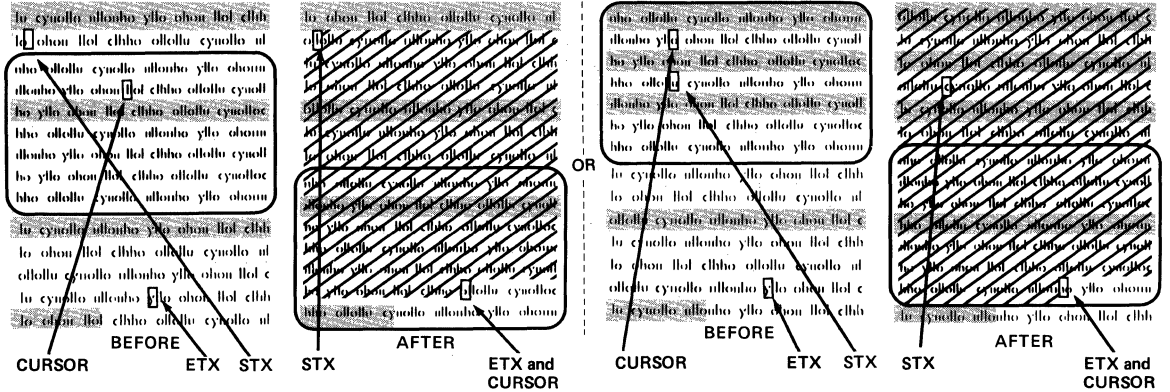

If the page lacks an STX character, transmission starts at home position through the ETX character. Moves the cursor to the ETX character.

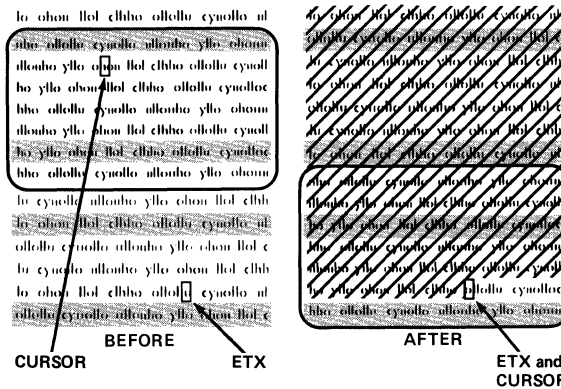

1. Default delimiters are given in the next section.
2. Transmission does not include any video attributes or the status of special graphics and write protect modes.

Table 4-19
Continued

Command	Effect
---------	--------

If the page lacks an ETX character, the terminal sends all data between either the STX character (if the cursor follows the STX character) or home (if the cursor is before the STX character) and end of page. Moves the cursor to home or first unprotected position.

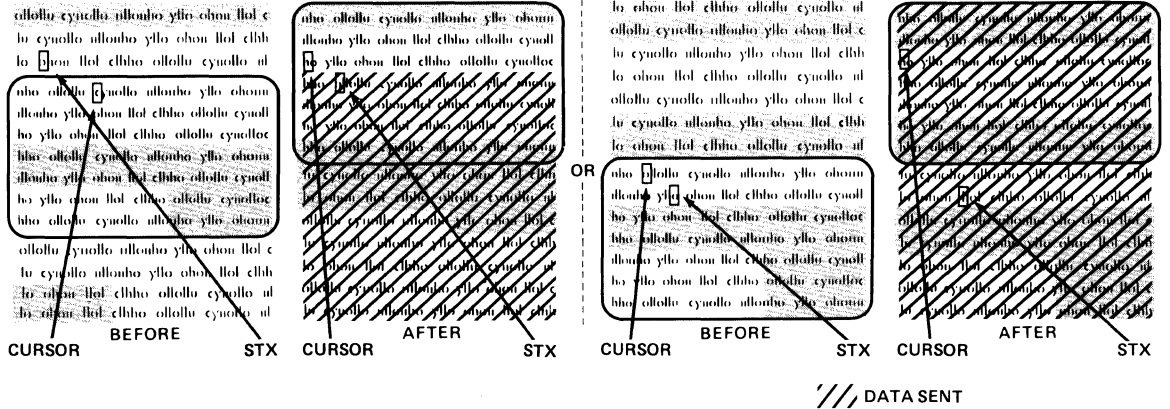

If the page has no STX or ETX characters, sends the entire page. Moves the cursor to home or first unprotected position.

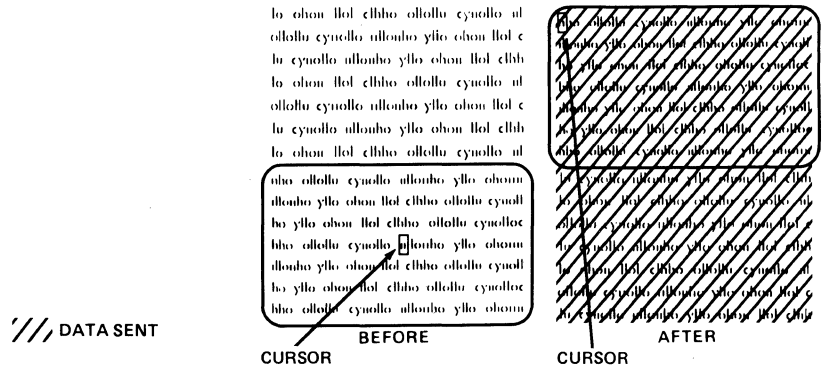

Delimiters¹—Sends line delimiter after each line, and termination character after the transmission.²

1. Default delimiters are given in the next section.
2. Transmission does not include any video attributes or the status of special graphics and write protect modes.

**Table 4-19
Continued**

Command	Effect
Send form	<p>Entire form—Sends everything between (and including) home and end of page, including escape sequences for embedded visual attributes (ESC G n). Does not move cursor.</p> <div style="display: flex; justify-content: space-around; align-items: center;"> <div style="border: 1px solid black; padding: 5px; width: 45%;"> <p>lo ohou lol elhho ollollu cyuollo ul ollollu cyuollo ullouho ylllo ohou lol e lu cyuollo ullouho ylllo ohou lol elh lo ohou lol elhho ollollu cyuollo ul ollollu cyuollo ullouho ylllo ohou lol e lu cyuollo ullouho ylllo ohou lol elh lo ohou lol elhho ollollu cyuollo ul</p> </div> <div style="border: 1px solid black; padding: 5px; width: 45%; background-color: #cccccc;"> <p>lo ohou lol elhho ollollu cyuollo ul ollollu cyuollo ullouho ylllo ohou lol e lu cyuollo ullouho ylllo ohou lol elh lo ohou lol elhho ollollu cyuollo ul ollollu cyuollo ullouho ylllo ohou lol e lu cyuollo ullouho ylllo ohou lol elh lo ohou lol elhho ollollu cyuollo ul</p> </div> </div> <div style="display: flex; justify-content: space-around; margin-top: 5px;"> BEFORE AFTER </div>

Delimiters¹—Sends ESC) before each write-protected field, ESC (after each write-protected field, line delimiter after each line, and termination character after the transmission. Marks areas containing special graphics characters with ESC \$ and ESC %.

1. Default delimiters are given in the next section.
2. Transmission does not include any video attributes or the status of special graphics and write protect modes.

Defining How Much Will Be Sent

The amount of data sent to the computer by the previous commands are, in some cases, defined with **delimiters**. Delimiters are data separators used to indicate how much has been sent (i.e., a field, a line) or the end of the transmission. Table 4-20 lists the default delimiter values

**Table 4-20
Default Delimiter Values**

Delimiter	Values	
	P ₁	P ₂
Field	FS	null
Line	US	null
End of text	CR	null

Miscellaneous Send Commands

Send terminal's identification (TVS 924 REV. n CR) ESC M

where

n is an uppercase alphabetic character that identifies the revision level of the terminal's firmware.

The terminal identifies itself to the computer when it receives this command.

Send answerback code ESC ^ 0

This command tells the terminal to send its unique answerback code (identifying the terminal) to the computer. Unless you reprogram the answerback code (as described in the next chapter), the terminal sends the terminal identification TVS 924 REV. n (described above) as the answerback code.

Send the message line or current status line ESC Z n

where

n defines which line is sent.

n Value	Sends
0	Message line ¹
1	Current configuration of status line ¹

1. Transmission is followed by a CR character.

This command sends the current message or status line to the computer.

Printing

Buffered extension print mode on	SET UP
Buffered extension print mode off	ESC @
Buffered transparent print mode on	ESC A
Buffered transparent print mode off	ESC ~
Print page	ESC a
Bidirectional port communication on	ESC P n
Bidirectional port communication off	CTRL R
	CTRL T

where

n defines the type of data printed and whether it is formatted.

n Value	Type of Page Print
1	Formatted unprotected ^{1, 2}
2	Formatted protected ²
3	Formatted all ²
4	Unformatted all ^{3, 4}

1. Same as PRINT key unless it is reprogrammed.
2. Does not print special graphics characters.
3. Same as shifted PRINT key unless it is reprogrammed.
4. Does not send CR, LF, and null characters to printer at end of each line.

NOTE! All print modes except page print are mutually exclusive; i.e., you can only enable one at a time. After a page print, the terminal returns to previous print mode.

If you sound the bell or turn keyclick on or off (from either the keyboard or the computer) during any buffered print mode, the printer may slow down.

These commands specify how much is printed and whether or not the data is displayed on the screen at the same time. Table 4-21 describes the printing modes and commands.

Table 4-21
Print Escape Sequences

Name	Effect
Buffered extension print on	Enables buffered extension print mode. Sends all data received from the computer to the screen and to the terminal's printer. Allows baud rates to computer and printer to differ.
Buffered extension print off	Disables buffered extension print mode. Screen continues to display new data. Any data remaining in the terminal's print buffer continues going to the printer until the print buffer is empty.
Buffered transparent print on	All data received from the computer passes through the terminal to the printer without being displayed on the screen. Baud rates can differ.
Buffered transparent print off	Printing stops as soon as the terminal's print buffer empties. Data goes to the screen if it is received from the computer after the terminal receives this command.
Page print command ¹	<p data-bbox="678 1430 1492 1507">Sends a page of data (starting with page's first character position and continuing through the cursor position) to the device attached to the terminal's printer port. Prints data from page's first position through cursor.</p> <p data-bbox="678 1535 1492 1696">Allows terminal to print a page while accepting data and displaying it on a new page (if additional memory is configured as more than one page). However, when logical attribute mode is on and the cursor is in a field with logical attribute of total fill or must enter and memory contains two or more pages, prints the current page but the does not flip the display to the next page. Sends space characters in place of each special graphics character.²</p> <p data-bbox="678 1724 1492 1772">Can be used while any print mode is on. The terminal returns to the previous print mode when page print is finished.</p>

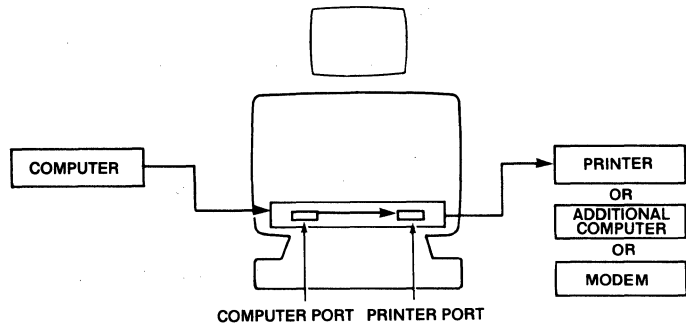
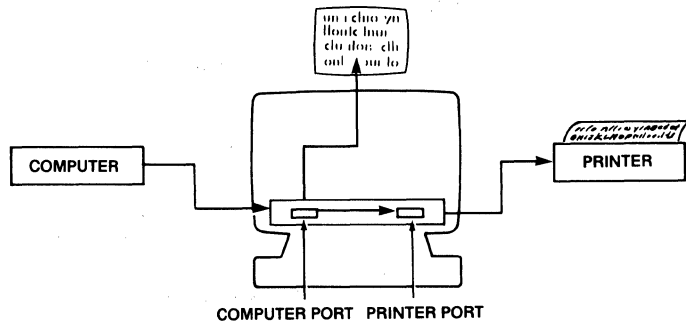

1. Page print is a command, not a print mode.
2. A termination character (default ACK) indicates transmission is finished.

Table 4-21
Continued

Name	Effect
Page print command	
Formatted unprotected	Prints all unprotected characters on the screen from the page's first position through the cursor position. Space characters replace any protected and special graphics characters. Adds CR, LF, and null characters after each line.
Formatted protected	Only prints protected characters from the page's first position through the cursor. Space characters replace any unprotected and special graphics characters. Adds CR, LF, and null characters after each line.
Formatted all	Prints all characters on page between page's first position through cursor (except special graphics characters, which are replaced with space characters).
Unformatted all	Prints data from the page's first position through the cursor position. Not limited to screen display if extra memory has been added; i.e., advances screen to the next page. Does not add CR, LR, and null characters at the end of each line.
Bidirectional on	<p>Enables bidirectional communication between devices attached to the terminal's computer and printer ports. Data sent from the computer goes to the screen and terminal's printer (can lock keyboard). Data sent from a KSR printer to the computer passes through the terminal but does not affect it (can't unlock keyboard if it has been locked). Does not display data sent through the printer port to the computer port.</p> <p>Since both devices attached to the terminal must use the same baud rate, parity, word structure, and stop bits, the printer port automatically changes to match the computer port's configuration when you turn on bidirectional communication. When you turn it off, the printer port returns to its previous configuration.</p>
Bidirectional off	Turns off bidirectional communication between terminal's ports; resets printer port's baud rate.

The appearance of the printed copy depends on whether the data is formatted or unformatted. Figure 4-13 shows data as it might be displayed on the screen and the different ways the printed copy could appear.

Figure 4-13
Appearance of Printed Copy from Formatted and Unformatted Data

a. Displayed Data

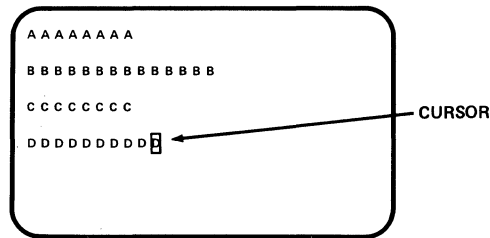

b. Case 1

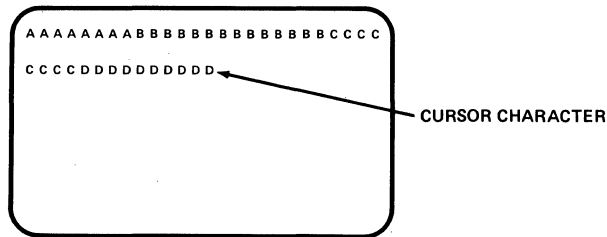

c. Case 2

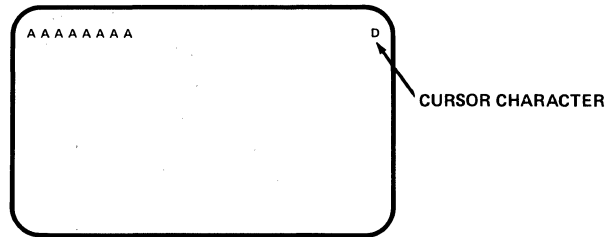

d. Case 3

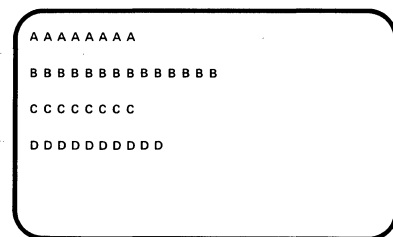

Unformatted Printing—In Case 1, you cleared the screen to null characters before entering data and entering the ESC P 4 command. The printer automatically added CR and LF delimiters after each printed line, so this printed copy includes all of the data. However, since you first cleared the screen to null characters, the text lacks the spaces needed to make it resemble the displayed text.

In Case 2, you cleared the screen to spaces before entering data and entering the ESC P 3 command. The printer does not automatically add CR and LF delimiters at end of each line as it prints, so this printed copy contains only one line of data. The remainder of the data accumulated (piled up) on the last cursor position.

In Case 3, you cleared the screen to space characters before entering data and entering the ESC P 4 command. The printer automatically added CR and LF delimiters after each printed line, so this hardcopy includes all the data. Since the screen was cleared to spaces, the printed copy includes the spaces needed to make it resemble the screen display.

Formatted Printing—The page of data shown in Case 3 also reflects what the ESC P 3 command prints. Because the printer received CR and LF delimiters with the data from the terminal, the printed copy duplicates the screen image. The printer's ability to add delimiters (and the method used) and whether or not you cleared the screen first is irrelevant.

Printer Handshaking Protocols

If a printer connected to the terminal sends X-Off to the terminal or lowers the DTR line's voltage, the terminal stops sending more data to the printer until the printer sends X-On or raises the DTR line's voltage. Table 4-22 describes how the print mode or command affects handshaking protocols.

Table 4-22
Printer Port Handshaking Protocols¹

Print Mode/Command	Handshaking Protocol
Buffered extension	<p>If terminal receives X-Off from printer or DTR line voltage drops, terminal stops sending data from its print buffer. Print buffer fills up first, then receive buffer. When receive buffer contains 224 characters, terminal sends X-Off to computer or lowers DTR line voltage.</p> <p>When receive buffer contains only 16 characters, terminal sends X-On to computer or raises DTR line voltage.</p>
Buffered transparent print	<p>If terminal receives X-Off from printer or DTR line voltage drops, terminal stops sending data from its print buffer. When print buffer fills up, terminal sends X-Off to computer. If computer fails to respond to first X-Off and receive buffer contains 224 characters, terminal sends second X-Off to computer or raises DTR line voltage.</p> <p>When receive buffer contains only 16 characters, terminal sends X-On to computer or raises DTR line voltage.</p>
Page print	<p>Computer should stop sending data to terminal. If printer sends X-Off to terminal or lowers DTR line voltage, terminal stops sending data to printer until printer sends X-On or raises DTR line voltage. Status line contains PBSY, indicating printer is busy. When all data has been sent to printer port, terminal sends ACK (ASCII character) to computer, signaling it to resume sending data to terminal.</p>
Bidirectional port communication	<p>Uses no handshaking protocols.</p>

1. Assumes printer or modem is connected to terminal's printer port.



5. Reprogramming the Terminal

Introduction

This chapter helps you reprogram many of the terminal functions described in Chapters 2 through 4.

Port Control

Define port parameters

SET UP
ESC { m p₁ p₂ p₃ p₄

where

m is the terminal's port whose parameters are to be changed.

m Value	Port
0	Computer port
1	Printer port

p₁ is the baud rate.

p ₁ Value	Baud Rate
0	150
1	300
2	1200
3	1800
4	2400
5	4800
6	9600
7	19200

p₂ defines the word structure.

p ₂ Value	Word Length
0	7 bits
1	8 bits

p₃ is parity.

p ₃ Value	Parity
0	Even (receive/transmit)
1	Odd (receive/transmit)
2	No

p₄ is the number of stop bits.

p ₄ Value	Stop Bits
0	1
1	2

NOTE! *The parameters defined with this command are effective only until the power is turned off.*

With this command you can temporarily change the parameters of either of the terminal's ports.

For example, if you enter

ESC { 0 5 0 0 0

the computer port's parameters become

Baud rate	4800
Word length	7 bits
Parity	Even
Stop bits	One

Delimiters

Define delimiter code

ESC x (code)

where

(code) must contain the byte values for a total of eight ASCII characters.

To change a delimiter character, determine the byte value of the new character. Each delimiter contains two ASCII characters.

Enter the byte values for all codes (listed below) in sequence.

Delimiter	Default ASCII Character	Byte Value
Field separator	FS NUL	1C 00
Line separator	US NUL	1F 00
Send terminator	CR NUL	0D 00
Page print terminator	ACK NUL	06 00

NOTE! *Nulls in the delimiter code are not sent to the computer.*

Answerback Message

Change answerback text

ESC ^ 1 (text) CTRL Y

where

(text) is a message containing up to 16 characters.

To include a CTRL Y or CTRL P in the text, precede it with a CTRL P (which is not counted as a character in the text).

You can change the response (called the answerback) given by the terminal when the computer asks the terminal to identify itself.

Keys

One Editing Key

Reprogram one editing key

ESC 0 m a b c

where

m	Key	Default Function Unshifted	Default Codes		
			Hex	ASCII	
@	HOME	Cursor home	1E 00 00	RS	NUL NUL
A	↓	Cursor down	16 00 00	SYN	NUL NUL
B	↑	Cursor up	0B 00 00	VT	NUL NUL
C	←	Cursor left	08 00 00	BS	NUL NUL
D	→	Cursor right	0C 00 00	FF	NUL NUL
E	TAB ¹	Tab cursor	09 00 00	HT	NUL NUL
F	BACK TAB	Back tab	1B 49 00	ESC	I NUL
G	CLEAR	Clear unprotected to spaces	1A 00 00	SUB	NUL NUL
H	PRINT	Print unprotected page	1B 50 31	ESC	P 1
I	CHAR INSERT	Insert character	1B 51 00	ESC	Q NUL
J	CHAR DELETE	Delete character	1B 57 00	ESC	W NUL
K	LINE INSERT	Insert line	1B 45 00	ESC	E NUL
L	LINE DELETE	Delete line	1B 52 00	ESC	R NUL
M	LINE ERASE	Erase line with spaces	1B 54 00	ESC	T NUL
N	PAGE ERASE	Erase page with spaces	1B 59 00	ESC	Y NUL
O	PAGE	Next page	1B 4B 00	ESC	K NUL
P	SEND	Send line	1B 53 33	ESC	S 3
Q	TAB ²	Tab cursor	09 00 00	HT	NUL NUL
R	CE	Clear entry	18 00 00	CAN	NUL NUL
S	ENTER	Carriage return	0D 00 00	CR	NUL NUL

Default Function Shifted

~	HOME	Cursor home	1E 00 00	RS	NUL NUL
a	↓	Line feed	0A 00 00	LF	NUL NUL
b	↑	Reverse line feed	1B 6A 00	ESC	j NUL
c	←	Cursor left	08 00 00	BS	NUL NUL
d	→	Cursor right	0C 00 00	FF	NUL NUL
e	TAB ¹	Tab cursor	09 00 00	HT	NUL NUL
f	BACK TAB	Back tab	1B 49 00	ESC	I NUL
g	CLEAR	Clear all to nulls	1B 2A 30	ESC	* 0
h	PRINT	Print all page	1B 50 33	ESC	P 3
i	CHAR INSERT	Insert character	1B 51 00	ESC	Q NUL
j	CHAR DELETE	Delete character	1B 57 00	ESC	W NUL
k	LINE INSERT	Insert line	1B 45 00	ESC	E NUL
l	LINE DELETE	Delete line	1B 52 00	ESC	R NUL
m	LINE ERASE	Erase line with nulls	1B 74 00	ESC	t NUL
n	PAGE ERASE	Erase page with nulls	1B 79 00	ESC	y NUL
o	PAGE	Previous page	1B 4A 00	ESC	J NUL
p	SEND	Send page	1B 53 37	ESC	S 7
q	TAB ²	Tab cursor	09 00 00	HT	NUL NUL
r	CE	Clear entry	18 00 00	CAN	NUL NUL
s	ENTER	Carriage return	0D 00 00	CR	NUL NUL

1. On alphanumeric section of keyboard
2. On accounting keypad

a, b, and c are the three ASCII characters being programmed into the key.

Nulls can be included but are not transmitted.

This command allows you to change the code that the terminal sends when the specified shifted/unshifted editing key is pressed.

All Editing Keys

Reprogram all editing keys

ESC] n <codes>

where

n	Key
0	Unshifted
1	Shifted

<codes> must contain 60 bytes for all 20 editing keys.

To reprogram both shifted and unshifted editing keys, send the command twice with different n values.

This command allows you to change function of any editing key listed in the above table by changing the code sent by it.

NOTE! This command differs from the preceding command in that the values for each key up to and including the key to be changed must be reentered. Use this command when you want to reprogram all editing keys; use the previous command when you want to change only one key.

How Much Can Be Programmed into Each Key

Each editing key can send up to three codes (i.e., shifted sends three and unshifted sends three).

Entering a Sample Program

To illustrate how to reprogram an editing key, let's enter a command that will reverse the effect of the shifted ↑ and ↓ keys. After the terminal receives this code, the shifted ↓ key will cause a reverse line feed and the shifted ↑ key will cause a line feed.

1. Press

ESC] 1

to start the programming sequence. Everything entered after this is considered part of the program.

2. Enter, in a string without spaces, the following codes for shifted keys:

RS	NUL NUL	(This leaves the home key's function unchanged.)
LF	NUL NUL	(This changes the ↓ key's function.)
ESC j	NUL	(This changes the ↑ key's function.)

NOTE! Since the remainder of the values are not changed, you do not need to reenter them. The computer assumes default values for the remaining shifted keys.

Function Key(s)

Reprogram a function key

ESC | p₁ p₂ (message) CTRL Y

where

p₁ is a value for the function key's number.

Key	p ₁ Value	
	Unshifted	Shifted
F1	1	A
F2	2	B
F3	3	C
F4	4	D
F5	5	E
F6	6	F
F7	7	G
F8	8	H
F9	9	I
F10	:	J
F11	;	K
F12	<	L
F13	=	M
F14	>	N
F15	?	O
F16	@	P

p₂ is a value for the communication mode.

p ₂ Value	Effect
1	Send code to computer
2	Send code to terminal
3	Send code to both computer and terminal

(message) is the message to be transmitted by that function key. The message can contain any combination of alphanumeric characters, control code(s), or escape sequences. Enter a CTRL P when the next character in the message is a CTRL Y or CTRL P to be embedded (incorporated) as part of the message.

CTRL Y ends the programming sequence.

How Long Can the Message Be?

The memory for all function keys contains 512 bytes (256 shifted and 256 unshifted). If each key's program were to be the same size, each could include 16 characters less one character per key for control purposes. The maximum text length for each key (shifted or unshifted) is 63 characters.

To determine how much can be programmed in each key, you need to know how many keys are going to be used. If you don't need all 32 keys, the message for the few keys you do use can be larger.

What Can the Message Include?

The message can include an alphanumeric message displayed on the screen plus control codes and escape characters. For instance, you could tell the terminal to move the cursor to the end of the page, remind the operator to turn on the printer, and instruct the terminal to print the contents of the current page. The message to the operator appears on the screen while the messages to the terminal are stored as escape sequences.

Determining Where the Program Goes

The value entered for p_2 determines the destination of the program. If you send it to the screen, the computer or terminal cannot act upon it. And if you send it only to the computer, the message can not appear on the screen.¹ Think about who needs to receive the message and enter the appropriate p_1 value.

1. Unless the computer echoes it back to the terminal. This may occur if the computer is in full duplex.

Entering a Sample Program

To illustrate how a function key is reprogrammed, let's enter a command to print the contents of the current page on a printer connected to the terminal whenever the shifted function key F1 is pressed.

1. Press

ESC I

to start the programming sequence. Everything entered after this and before the terminating CTRL Y code is considered part of the program.

2. Press

A

designating you want to change the value of the shifted F1 key.

3. Press

2

to send the message to the terminal. (Since the printer is not connected to the computer, the computer is not involved in this procedure.)

4. Press

ESC = 7 n

where 7 and n are the values of the current page's last row (line) and column position.

When the terminal receives this sequence, it moves the cursor to the end of the page to define the amount to be printed.

5. Press

ESC s 1

to display the message line.

6. Press

ESC f

to send the following message to the message line.

7. Enter

TURN ON THE PRINTER CTRL P CTRL Y

When the terminal receives this message, it displays it on the message line.

8. Press

ESC P 3

to turn on page print.

9. Press

ESC s 2

to turn on the status line.

10. Press

CTRL Y

to end the program contained by the shifted F1 key.

To calculate the bytes in this example, let's look at it in its entirety.

ESC!A 2 ESC = 7 n ESC s 1 ESC f TURN ON THE PRINTER CTRL P CTRL Y ESC P 3 ESC s 2
 CTRL Y

Now let's tally the bytes.

Bytes	Entry	Bytes	Entry
1	ESC	1	H
1	=	1	E
1	7	1	<space>
1	n	1	P
1	ESC	1	R
1	s	1	I
1	1	1	N
1	ESC	1	T
1	f	1	E
1	T	1	R
1	U	0	CTRL P
1	R	1	CTRL Y
1	N	1	ESC
1	<space>	1	P
1	O	1	3
1	N	1	ESC
1	<space>	1	s
1	T	1	2

This message contains 35 bytes.

Whenever the shifted F1 key is pressed, the terminal moves the cursor to the end of the current page, displays the message TURN ON THE PRINTER, performs a page print, then turns the status line display on again.

Message Line

Load text into message line

ESC f <text> CTRL Y

where

<text> is up to 80 printable, displayable characters plus up to 15 visual attribute commands for each character in the text.

The message line's current visual attribute is included unless you change it. (Default is reverse video.)

This command lets you load a message in RAM for the message line.

By displaying the 25th line first, you can see the data on the 25th line as you enter it.

NOTE! *Until you program the message line, it is blank.*

6. Troubleshooting

Introduction

This chapter tells you what to check before placing a service call. It also shows you how to change the fuses and obtain assistance.

Self Tests

You can verify the proper operation of the terminal's video display circuitry and the computer and printer ports by running two self tests.

If the terminal passes both tests and the terminal still fails to operate correctly, consult the troubleshooting guide in Table 6-1 before placing a service call.

STOP! Running either self test clears the current page.

Self Testing the Video Display Circuitry

The first self test checks the video display circuitry. The test shows all displayable characters and the 32 possible visual attributes.

NOTE! Before starting the test, put the terminal in full duplex mode.

1. Press (in sequence):

SET UP 1

NOTE! You could enter the sequence ESC V instead.

2. Watch for the test screen (shown in Figure 6-1) to appear.

Figure 6-1
Screen During First Self Test

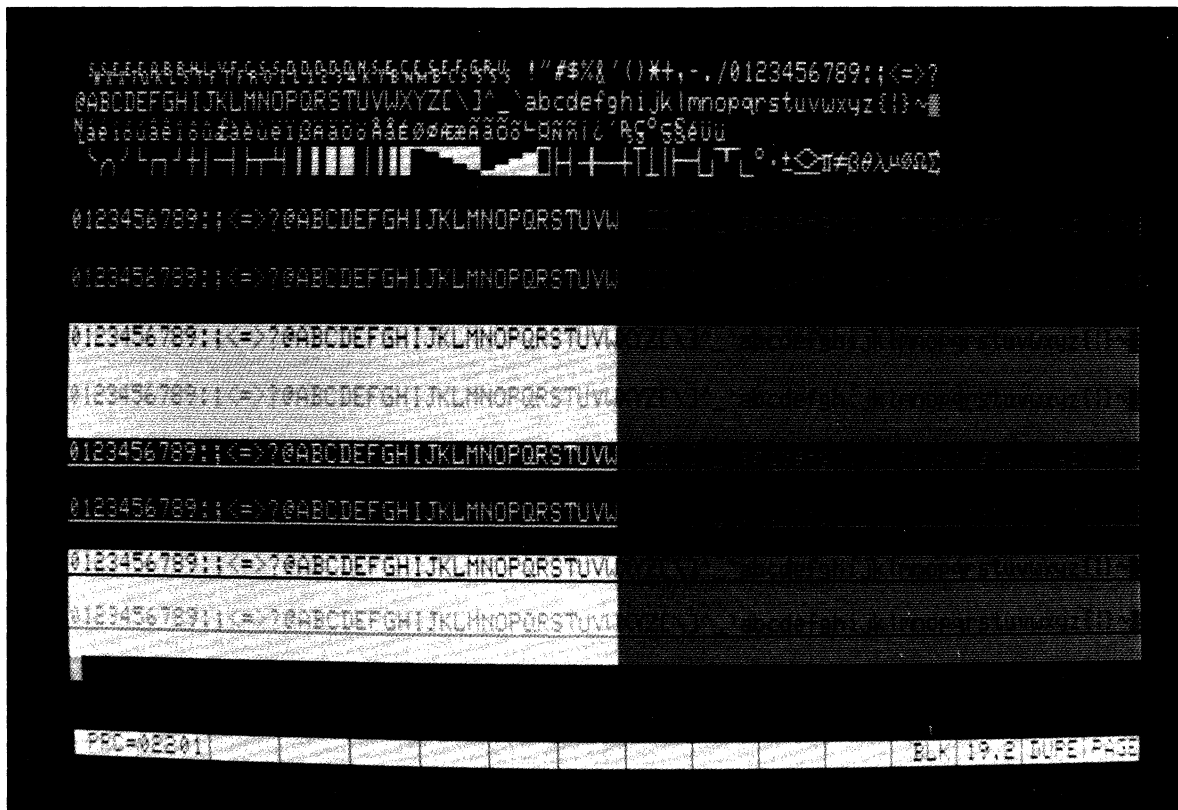

3. Check the screen with the screen shown in the figure.

Four lines should blink.

All characters should be displayed.

Each character should be formed properly.

You should not see any extra dots and no dots should be missing.

All visual attributes and decreased intensity characters should appear as shown in the figure.

4. Press **SET UP** to stop the test.

Self Testing Port Communications

The second self test checks the computer and printer ports by sending two sets of data from each port to the other.

NOTE! Before starting the test, make sure each port is configured with the same parity, stop bits, and word length.

1. Connect pins 3 and 4 on the RS-232C computer port to pins 3 and 4 on the printer port (using a prefabricated test cable with 25-pin RS-232C male connectors at each end). (The pin numbers are shown in Figure 1-9.)

2. Press (in sequence):

SET UP 2

3. Wait a second or two while the terminal performs the four tests. (Nothing appears on the screen during the actual tests.)
4. Watch the screen. The word **PASS** or **FAIL** appears on the screen after each test. (Tests 1 and 2 send data from the computer port to the printer port; tests 3 and 4 send data from the printer port to the computer port.)
5. If any tests fail, check the baud rates, stop bits, and word length for each port. They should be the same for each port. Make sure the interface cable is securely attached and configured correctly. Run the test a second time.

If any of the tests fail again and you are sure the port configurations and interface cable are correct, place a service call.

6. Press **SET UP** again to stop the test and reenable the previous communication mode.
7. Press **CLEAR** to clear the self test display from the screen.

Troubleshooting Procedures

Before placing a service call, find the symptom in Table 6-1 and try the solution listed there.

Table 6-1
Troubleshooting Terminal Problems

Symptom	Possible Solution
Terminal dead (no beep; no cursor)	Unplug power cord and plug in both ends again
	Check and replace line supply fuse
	Check and replace power supply fuse(s)
	Remove cover and inspect connectors and chips on logic board
	Turn on power switch
Terminal dead; cursor may appear	Unplug power cord and change line supply fuse
	Check and replace power supply fuse(s)
Terminal will not go on line	Make sure system is "up"
	Disconnect all cables and check for damage, then reattach
	Check RS-232C (computer) port interface cables:
	Pins 1 and 7 must be grounded
	Pin 2 must be connected to computer receiver
	Pin 3 must be connected to the computer transmitter
	Pins 5, 6, and 8 must be driven by + 12 volt dc power or be disconnected
	Turn on modem
	Connect a different modem
	Check handset position in modem cradle
Cursor will not appear	Adjust screen contrast
	Remove cover and inspect power supply and video connectors; check for loose chips on logic board (see next section)
Computer does not respond while on line	Set parity, word structure, and stop bits to match computer's requirements
No keyboard response	Unplug and reattach both ends of keyboard cable
	STOP! This may reset the terminal, which would clear the screen.
	Change to half duplex with set up mode
Terminal locked up	Press CTRL and RESET
	Review all set up line parameters
Terminal prints correct data only part of the time or prints @ signs	Check computer system's parity needs
	Review stop bits and word structure in set up lines

**Table 6-1
Continued**

Symptom	Possible Solution
Display is wavy or beep sounds unusual	Change hertz setting in set up line
Display is blurry	Remove cover and inspect power supply and video connectors; check for loose chips on logic board (see next section); adjust focus on video module.
Printer does not print what is typed	Check print mode and command Check baud rate, parity and word structure of printer port Check printer cable's pin assignments Pins 4 and 20 must be driven by +12 volt dc or disconnected Pin 3 must be connected to printer data input Pin 2 must be connected to printer data output for operation with X-On/X-Off control Check printer parameters in set up lines
Escape and control codes do not function as expected	Check escape sequences and control codes Make sure upper- and lowercase letters are used as required. Is a one used instead of lowercase letter L? Zero for uppercase O? Make sure the ALPHA LOCK key is not engaged. Disconnect the interface from the terminal's computer port; connect computer port's pins 2 and 3; try operating in full duplex Try ESC sequences with LOC ESC key

Inspection

If the terminal exhibits symptoms of loose chips or connectors as described in Table 6-1, inspect the logic board.

STOP! Do not proceed with the directions in this section unless you are a trained service technician. This procedure exposes components that retain hazardous voltages even after you turn off the power.

1. Disconnect all interface cables and the keyboard cable.
2. Unplug the terminal from the wall outlet.
3. Unscrew the two Phillips head screws holding on the terminal cover (Figure 1-1).
4. Lift the cover towards you and up (Figure 1-2).

STOP! DO NOT TOUCH THE BACK OF THE CATHODE RAY TUBE (CRT). The black suction cup connected to its top is a high-voltage connector which can retain a potentially fatal electrical charge of up to 15,000 volts—even with the power turned off—unless a qualified technician discharges the voltage.

5. Remove the two screws holding the logic board and shroud on the terminal case (Figures 1-13 and 1-14).
6. Disconnect the white video connector from location P2 on the logic board (Figure 6-2).
7. Disconnect the red power supply connector from location P5 on the logic board (Figure 6-2).

NOTE! *There are two connectors attached to the internal power supply. Only one (either one) is attached to the board; the other one is tied back.*

8. Lift out the shroud and logic board (Figure 6-3).
9. Inspect the logic board and connectors for:
 - Loose chips
 - Loose video connector (upper center area of board)
 - Loose power supply connector (upper right area of board)
 - Loose keyboard connector (lower right area of board)

Figure 6-2
Logic Board and Connectors

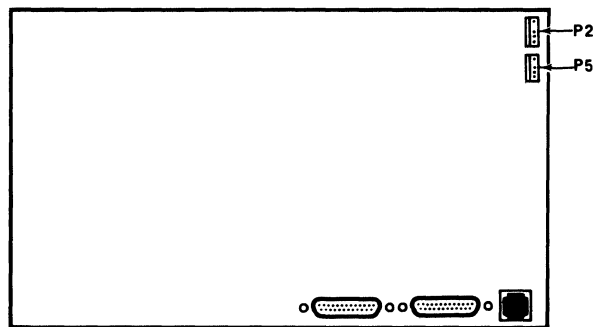
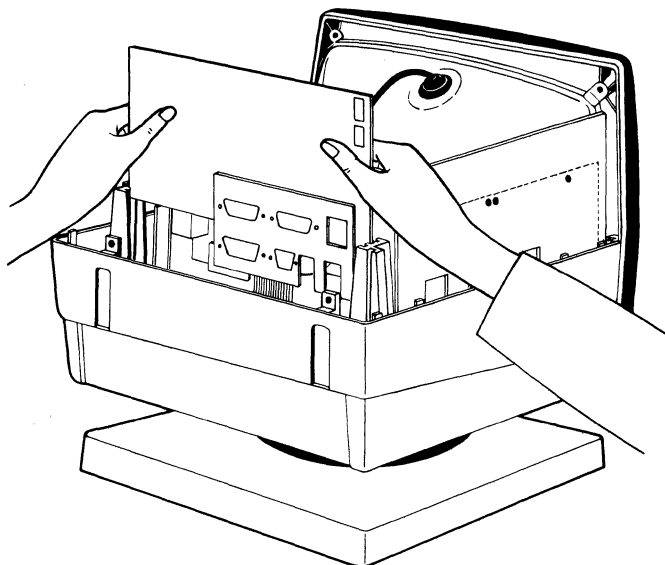

Figure 6-3
Removing the Logic Board from the Card Guide



10. Tighten any loose components.
11. Reattach the video and power supply connectors (see Step 5).
12. Slide the logic board back into the center slot on the card guides (Figure 6-3).
13. Position the shroud between the logic board and case back, matching the connector and screw holes.
14. Replace the two screws in the shroud lip and back case.
15. Replace the cover and screws, being careful not to overtighten the screws.
16. Reattach the interface and keyboard cables.
17. Plug the power cord into the terminal and wall outlet.
18. Retest the terminal again. If the terminal still has no power, check the power supply fuses (next section).

Checking the Fuses

Power Supply Fuses

The two power supply fuses are clipped onto the power supply assembly inside the terminal, as shown in Figure 6-4. If you suspect one of the power supply fuses is defective:

1. Unplug the terminal's power cord.
2. Remove the cover (following Steps 1 through 4 in the previous section).
3. Find the power supply fuses, shown in Figure 6-4.
4. Slip each fuse out of its clip and compare it to Figures 6-5 and 6-6.

Figure 6-4
Power Supply Fuses

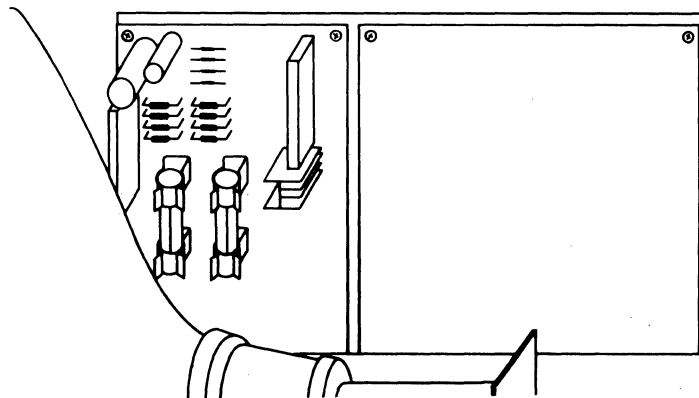

Figure 6-5
Good Fuse

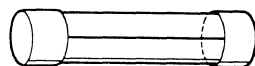
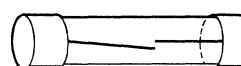

Figure 6-6
Burned-Out Fuse



5. Replace the suspected fuse with a 5-ampere, fast-blow fuse if necessary.
6. Replace the cover (Steps 13 through 15).
7. Retest the terminal.

Line Fuse

To check the line fuse:

1. Turn off the power and unplug the terminal's power cord (either from the terminal or from the wall outlet).
2. Remove the fuse holder by unscrewing it counterclockwise (Figure 6-7).

Figure 6-7
Line Fuse

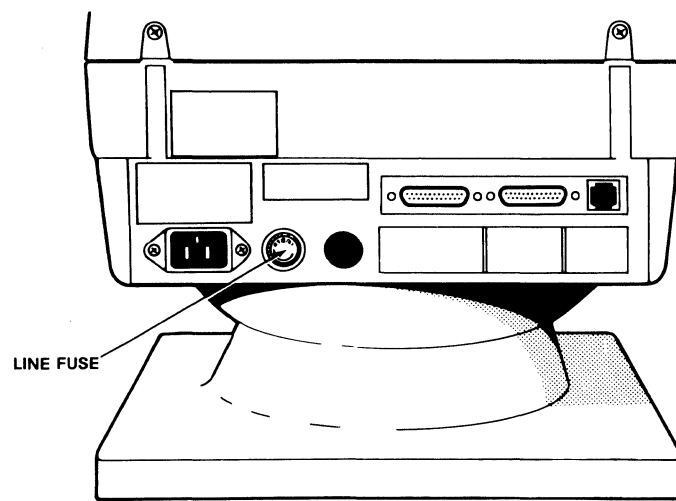

3. Slip the glass fuse out of the holder and examine it.

If the thin wire inside the fuse is intact (Figure 6-5), the fuse should be functional. If the thin strip is broken and/or the glass is slightly black (Figure 6-6), the fuse has blown and must be replaced. (A totally black fuse can indicate a problem with the power outlet. If that happens, call your service technician.)

4. Replace a blown fuse with a 1-ampere, fast-blow fuse for 110-volt applications or a 0.5-ampere, fast-blow fuse for 220-volt applications.
5. Replace and tighten the fuse holder.
6. Plug in the terminal power cord.

If the newly replaced fuse blows out immediately, do not replace it again. Call your service technician.

If You Need Assistance

TeleVideo has two service departments available to help you.

Call Technical Assistance when you want to know how to use the terminal in a particular computer environment or need marketing information.

Call Customer Service when you need help troubleshooting a hardware problem or want to return the terminal for repair.

Technical Assistance For Technical Assistance, call between 8:30 a.m. and 5:00 p.m., Pacific time, Monday through Friday (except holidays).

Customer Service Before you place a service call, refer to the Troubleshooting Guide in Table 6-1. Refer also to the index and find the section in the manual which covers that subject. Have the terminal and manual by the phone.

You can reach the Customer Service department by calling between 7:00 a.m. and 5:00 p.m., Pacific time, Monday through Friday, except holidays. If the line is busy, leave a message with the TeleVideo operator. We will return your call as soon as possible.

Service Under Warranty The terminal is covered by a limited warranty (see Appendix B). No warranty registration is required.

If you need service while the terminal is covered by the limited warranty, call our Customer Service Department (see previous section) for a Return Material Authorization number.

Reshipping the Terminal

Should you need to reship the terminal, follow these procedures:

1. Remove the cover (described earlier in this chapter).
2. Check the integrity of the cabling and the security of the internal mounting hardware.
3. Replace the cover, being careful not to overtighten the screws.
4. Repack the terminal, using either the original TeleVideo shipping container or other suitable materials.

Appendices

- A Specifications**
- B Statement of Limited Warranty**
- C ASCII Code Tables**
- D Monitor Mode Control Characters**
- E Cursor Coordinates**
- F Control Codes**
- G Escape Sequences**
- H Character Sets**
- I Set Up Memory Bit Map**

Appendix A Specifications

SCREEN

Size	12 inches measured diagonally
Attributes	P31 green nonglare phosphor with timeout Touch tilt (-5° to +20°) Swivel (360°)

DISPLAY FORMAT

24 80-column lines
25th status/set up/message line

CHARACTER FORMATION

7 x 8 dot matrix
8 x 10 cell with half-dot shift

CHARACTER SETS

US ASCII, UK, French, German, Spanish, Finnish/Swedish, Danish/Norwegian, and Portuguese

DISPLAYED CHARACTER SET

128 ASCII characters (96 upper- and lowercase alphanumeric with descenders, 32 control);
64 special graphics characters

CURSOR CONTROL

Home, up, down, right, left, carriage return, line feed, next page, previous page, typewriter and field tabs (forward and backward), addressable/readable visible cursor; hidden cursor

COMMUNICATIONS INTERFACE

Computer: RS-232C 256-character buffered transmit/receive port
Printer: RS-232C 256-character buffered port

COMMUNICATIONS MODES

Conversational (full or half duplex); block; monitor; local or duplex edit; self test

WORD STRUCTURE

7 or 8 data bits;
1 or 2 stop bits;
10- or 11-bit word

PARITY

Odd, even, none

COMMUNICATIONS PROTOCOL

X-On/X-Off or Data Terminal Ready at either RS-232C port

BAUD RATES

8 for each port (150 to 19,200 Kb)

PRINT CAPABILITIES

Page print (formatted/unformatted); extension (copy) print (buffered/bidirectional); transparent print (buffered/bidirectional)

CURSOR ATTRIBUTES

Block (blinking or steady); underline (blinking or steady); none

VIDEO ATTRIBUTES

Nonembedded, character-by-character, combinable; blink, blank, underline, half intensity, and reverse video; block graphics; block attributes

EDITING

Character/line insert/delete; line/page erase; smooth, normal, or no scrolling

KEYBOARD

Detached, slim-line, typewriter-style with sculptured keycaps; sealed key switches; N-key rollover with ghost key lockout; accounting-style numeric keypad with TAB and ENTER keys; 32 nonvolatile, programmable function keys; reconfigurable keyboard

FIELDS

Protected/unprotected; logical attributes; definable scrolling region; reprogrammable delimiters

Appendix A Continued

POWER REQUIREMENTS 115/230 volt ac, 50/60 Hz

DIMENSIONS	Height		Width		Depth	
	(in.)	(cm)	(in.)	(cm)	(in.)	(cm)
Cabinet	14.0	35.6	12.5	31.8	11.5	29.2
Keyboard	1.5	3.8	17.6	44.7	7.3	18.4
Footprint			12.4	31.3	10.9	27.7

WEIGHT

Net 26 pounds 6 ounces
Shipping 30 pounds

OPTIONS

Current loop
Neutral fuse
72 additional lines of screen memory
European base plate

Appendix B Statement of Limited Warranty

TeleVideo Systems, Inc. ("TeleVideo") warrants to its distributors, systems houses, and OEMs ("Buyer"), that products manufactured by TeleVideo are free from defects in materials and workmanship. TeleVideo's obligations under this warranty are limited to repairing or replacing, at TeleVideo's option, the part or parts of the products which prove defective in material or workmanship within 180 days after shipment by TeleVideo. Buyer may pass along to its initial customer or user ("Customer") a maximum of 90 days coverage within this 180-day warranty period, provided that Buyer gives TeleVideo prompt notice of any defect and satisfactory proof thereof.

Products may be returned by Buyer only after a Return Material Authorization number ("RMA") has been obtained from TeleVideo by telephone or in writing. Buyer will prepay all freight charges to return any products to the repair facility designated by TeleVideo and include the RMA number on the shipping container. TeleVideo will, at its option, either repair the defective products or parts or deliver replacements for defective products or parts on an exchange basis to Buyer, freight prepaid to the Buyer or the Customer. Products returned to TeleVideo under this warranty will become the property of TeleVideo. With respect to any product or part thereof not manufactured by TeleVideo, only the warranty, if any, given by the manufacturer thereof, applies.

Exclusions

This limited warranty does not cover losses or damage which occur in shipment to or from Buyer or Customer, or are due to, (1) improper installation or maintenance, misuse, neglect or any cause other than ordinary commercial or industrial application, or (2) adjustment, repair, or modifications by other than TeleVideo-authorized personnel, or (3) improper environment, excessive or inadequate heating or air conditioning and electrical power failures, surges, or other irregularities, or (4) any statements made about TeleVideo's products by salesmen, dealers, distributors or agents, unless confirmed in writing by a TeleVideo officer.

If the firmware or hardware is altered or modified by the Buyer or Customer, this firmware and hardware is not covered within this limited warranty and the Buyer or Customer bears sole responsibility and liability for that firmware and hardware.

THE FOREGOING TELEVIDEO LIMITED WARRANTY IS IN LIEU OF ALL OTHER WARRANTIES, WHETHER ORAL, WRITTEN, EXPRESSED, IMPLIED, OR STATUTORY. IMPLIED WARRANTIES OF MERCHANTABILITY AND FITNESS FOR A PARTICULAR PURPOSE DO NOT APPLY. TELEVIDEO'S WARRANTY OBLIGATIONS AND DISTRIBUTER'S REMEDIES HEREUNDER ARE SOLELY AND EXCLUSIVELY AS STATED HEREIN.

TELEVIDEO'S LIABILITY, WHETHER BASED ON CONTRACT, TORT, WARRANTY, STRICT LIABILITY, OR ANY OTHER THEORY, SHALL NOT EXCEED THE PRICE OF THE INDIVIDUAL UNIT WHOSE DEFECT OR DAMAGE IS THE BASIS OF THE CLAIM. IN NO EVENT SHALL TELEVIDEO BE LIABLE FOR ANY LOSS OF PROFITS, LOSS OF USE OF FACILITIES OR EQUIPMENT, OR OTHER INDIRECT, INCIDENTAL OR CONSEQUENTIAL DAMAGES.

Appendix C ASCII Code Tables

Table C-1
ASCII Code Chart

Bits	7 6 5 4 3 2 1				Column	0 0 0	0 0 1	0 1 0	0 1 1	1 0 0	1 0 1	1 1 0	1 1 1
	4	3	2	1	Row	0	1	2	3	4	5	6	7
	0	0	0	0	0	NUL	DLE	SP	0	@	P	`	p
	0	0	0	1	1	SOH	DC1	!	1	A	Q	a	q
	0	0	1	0	2	STX	DC2	"	2	B	R	b	r
	0	0	1	1	3	ETX	DC3	#	3	C	S	c	s
	0	1	0	0	4	EOT	DC4	\$	4	D	T	d	t
	0	1	0	1	5	ENQ	NAK	%	5	E	U	e	u
	0	1	1	0	6	ACK	SYN	&	6	F	V	f	v
	0	1	1	1	7	BEL	ETB	'	7	G	W	g	w
	1	0	0	0	8	BS	CAN	(8	H	X	h	x
	1	0	0	1	9	SKIP HT	EM)	9	I	Y	i	y
	1	0	1	0	10 (a)	LF	SUB	*	:	J	Z	j	z
	1	0	1	1	11 (b)	VT	ESC	+	;	K	[k	{
	1	1	0	0	12 (c)	FF	FS	,	<	L	\	l	
	1	1	0	1	13 (d)	CR	GS	-	=	M]	m	~
	1	1	1	0	14 (e)	SO	HOME RS	.	>	N	^	n	~
	1	1	1	1	15 (f)	SI	NEW LINE US	/	?	O	_	o	DEL RUB

Table C-2
ASCII Control Character Abbreviations

NUL	null	FF	form feed	CAN	cancel
SOH	start of heading	CR	carriage return	EM	end of medium
STX	start of text	SO	shift out	SUB	substitute
ETX	end of text	SI	shift in	ESC	escape
EOT	end of transmission	DLE	data link escape	FS	file separator
ENQ	enquiry	DC1	device control 1	GS	group separator
ACK	acknowledge	DC2	device control 2	RS	record separator
BEL	bell	DC3	device control 3	US	unit separator
BS	backspace	DC4	device control 4	SP	space
HT	horizontal tabulation	NAK	negative acknowledge	DEL	delete
LF	linefeed	SYN	synchronous idle		
VT	vertical tabulation	ETB	end of transmission block		

Appendix C Continued

Table C-3
ASCII Code Conversion Listing

ASCII Character	Binary									Octal	Decimal	Hex
	Bit Binary Value	7 128	6 64	5 32	4 16	3 8	2 4	1 2	0 1			
NUL		0	0	0	0	0	0	0	0	000	000	00
SOH		0	0	0	0	0	0	0	1	001	001	01
STX		0	0	0	0	0	0	1	0	002	002	02
ETX		0	0	0	0	0	0	1	1	003	003	03
EOT		0	0	0	0	0	1	0	0	004	004	04
ENQ		0	0	0	0	0	1	0	1	005	005	05
ACK		0	0	0	0	0	1	1	0	006	006	06
BEL		0	0	0	0	0	1	1	1	007	007	07
BS		0	0	0	0	1	0	0	0	010	008	08
HT		0	0	0	0	1	0	0	1	011	009	09
LF		0	0	0	0	1	0	1	0	012	010	0A
VT		0	0	0	0	1	0	1	1	013	011	0B
FF		0	0	0	0	1	1	0	0	014	012	0C
CR		0	0	0	0	1	1	0	1	015	013	0D
SO		0	0	0	0	1	1	1	0	016	014	0E
SI		0	0	0	0	1	1	1	1	017	015	0F
DLE		0	0	0	1	0	0	0	0	020	016	10
DC1		0	0	0	1	0	0	0	1	021	017	11
DC2		0	0	0	1	0	0	1	0	022	018	12
DC3		0	0	0	1	0	0	1	1	023	019	13
DC4		0	0	0	1	0	1	0	0	024	020	14
NAK		0	0	0	1	0	1	0	1	025	021	15
SYN		0	0	0	1	0	1	1	0	026	022	16
ETB		0	0	0	1	0	1	1	1	027	023	17
CAN		0	0	0	1	1	0	0	0	030	024	18
EM		0	0	0	1	1	0	0	1	031	025	19
SUB		0	0	0	1	1	0	1	0	032	026	1A
ESC		0	0	0	1	1	0	1	1	033	027	1B
FS		0	0	0	1	1	1	0	0	034	028	1C
GS		0	0	0	1	1	1	0	1	035	029	1D
RS		0	0	0	1	1	1	1	0	036	030	1E
US		0	0	0	1	1	1	1	1	037	031	1F
SP		0	0	1	0	0	0	0	0	040	032	20
!		0	0	1	0	0	0	0	1	041	033	21

Appendix C Continued

Table C-3
Continued

ASCII Character	Binary Value	Binary								Octal	Decimal	Hex
		Bit 7 128	6 64	5 32	4 16	3 8	2 4	1 2	0 1			
"		0	0	1	0	0	0	1	0	042	034	22
#		0	0	1	0	0	0	1	1	043	035	23
\$		0	0	1	0	0	1	0	0	044	036	24
%		0	0	1	0	0	1	0	1	045	037	25
&		0	0	1	0	0	1	1	0	046	038	26
' (apostrophe)		0	0	1	0	0	1	1	1	047	039	27
(0	0	1	0	1	0	0	0	050	040	28
)		0	0	1	0	1	0	0	1	051	041	29
*		0	0	1	0	1	0	1	0	052	042	2A
+		0	0	1	0	1	0	1	1	053	043	2B
, (comma)		0	0	1	0	1	1	0	0	054	044	2C
- (hyphen)		0	0	1	0	1	1	0	1	055	045	2D
. (period)		0	0	1	0	1	1	1	0	056	046	2E
/		0	0	1	0	1	1	1	1	057	047	2F
0		0	0	1	1	0	0	0	0	060	048	30
1		0	0	1	1	0	0	0	1	061	049	31
2		0	0	1	1	0	0	1	0	062	050	32
3		0	0	1	1	0	0	1	1	063	051	33
4		0	0	1	1	0	1	0	0	064	052	34
5		0	0	1	1	0	1	0	1	065	053	35
6		0	0	1	1	0	1	1	0	066	054	36
7		0	0	1	1	0	1	1	1	067	055	37
8		0	0	1	1	1	0	0	0	070	056	38
9		0	0	1	1	1	0	0	1	071	057	39
:		0	0	1	1	1	0	1	0	072	058	3A
;		0	0	1	1	1	0	1	1	073	059	3B
<		0	0	1	1	1	1	0	0	074	060	3C
=		0	0	1	1	1	1	0	1	075	061	3D
>		0	0	1	1	1	1	1	0	076	062	3E
?		0	0	1	1	1	1	1	1	077	063	3F
@		0	1	0	0	0	0	0	0	100	064	40
A		0	1	0	0	0	0	0	1	101	065	41
B		0	1	0	0	0	0	1	0	102	066	42
C		0	1	0	0	0	0	1	1	103	067	43

Appendix C Continued

Table C-3
Continued

ASCII Character	Binary								Octal	Decimal	Hex	
	Bit Binary Value	7 128	6 64	5 32	4 16	3 8	2 4	1 2				0 1
D		0	1	0	0	0	1	0	0	104	068	44
E		0	1	0	0	0	1	0	1	105	069	45
F		0	1	0	0	0	1	1	0	106	070	46
G		0	1	0	0	0	1	1	1	107	071	47
H		0	1	0	0	1	0	0	0	110	072	48
I		0	1	0	0	1	0	0	1	111	073	49
J		0	1	0	0	1	0	1	0	112	074	4A
K		0	1	0	0	1	0	1	1	113	075	4B
L		0	1	0	0	1	1	0	0	114	076	4C
M		0	1	0	0	1	1	0	1	115	077	4D
N		0	1	0	0	1	1	1	0	116	078	4E
O		0	1	0	0	1	1	1	1	117	079	4F
P		0	1	0	1	0	0	0	0	120	080	50
Q		0	1	0	1	0	0	0	1	121	081	51
R		0	1	0	1	0	0	1	0	122	082	52
S		0	1	0	1	0	0	1	1	123	083	53
T		0	1	0	1	0	1	0	0	124	084	54
U		0	1	0	1	0	1	0	1	125	085	55
V		0	1	0	1	0	1	1	0	126	086	56
W		0	1	0	1	0	1	1	1	127	087	57
X		0	1	0	1	1	0	0	0	130	088	58
Y		0	1	0	1	1	0	0	1	131	089	59
Z		0	1	0	1	1	0	1	0	132	090	5A
[0	1	0	1	1	0	1	1	133	091	5B
\		0	1	0	1	1	1	0	0	134	092	5C
]		0	1	0	1	1	1	0	1	135	093	5D
^		0	1	0	1	1	1	1	0	136	094	5E
_ (underline)		0	1	0	1	1	1	1	1	137	095	5F
`		0	1	1	0	0	0	0	0	140	096	60
a		0	1	0	0	0	0	0	1	141	097	61
b		0	1	1	0	0	0	1	0	142	098	62
c		0	1	1	0	0	0	1	1	143	099	63
d		0	1	1	0	0	1	0	0	144	100	64
e		0	1	1	0	0	1	0	1	145	101	65

Appendix C Continued

Table C-3
Continued

ASCII Character	Binary Value	Binary								Octal	Decimal	Hex
		Bit 7 128	6 64	5 32	4 16	3 8	2 4	1 2	0 1			
f		0	1	1	0	0	1	1	0	146	102	66
g		0	1	1	0	0	1	1	1	147	103	67
h		0	1	1	0	1	0	0	0	150	104	68
i		0	1	1	0	1	0	0	1	151	105	69
j		0	1	1	0	1	0	1	0	152	106	6A
k		0	1	1	0	1	0	1	1	153	107	6B
l		0	1	1	0	1	1	0	0	154	108	6C
m		0	1	1	0	1	1	0	1	155	109	6D
n		0	1	1	0	1	1	1	0	156	110	6E
o		0	1	1	0	1	1	1	1	157	111	6F
p		0	1	1	1	0	0	0	0	160	112	70
q		0	1	1	1	0	0	0	1	161	113	71
r		0	1	1	1	0	0	1	0	162	114	72
s		0	1	1	1	0	0	1	1	163	115	73
t		0	1	1	1	0	1	0	0	164	116	74
u		0	1	1	1	0	1	0	1	165	117	75
v		0	1	1	1	0	1	1	0	166	118	76
w		0	1	1	1	0	1	1	1	167	119	77
x		0	1	1	1	1	0	0	0	170	120	78
y		0	1	1	1	1	0	0	1	171	121	79
z		0	1	1	1	1	0	1	0	172	122	7A
{		0	1	1	1	1	0	1	1	173	123	7B
		0	1	1	1	1	1	0	0	174	124	7C
}		0	1	1	1	1	1	0	1	175	125	7D
~		0	1	1	1	1	1	1	0	176	126	7E
DEL		0	1	1	1	1	1	1	1	177	127	7F

Appendix D Monitor Mode Control Characters

Code	ASCII	Hex	Character Displayed
CTRL @	NULL	00	N _L
CTRL A	SOH	01	S _H
CTRL B	STX	02	S _X
CTRL C	ETX	03	E _X
CTRL D	EOT	04	E _T
CTRL E	ENQ	05	E _Q
CTRL F	ACK	06	A _K
CTRL G	BEL	07	B _L
CTRL H	BS	08	B _S
CTRL I	HT	09	H _T
CTRL J	LF	0A	L _F
CTRL K	VT	0B	V _T
CTRL L	FF	0C	F _F
CTRL M	CR	0D	C _R
CTRL N	SO	0E	S _O
CTRL O	SI	0F	S _I
CTRL P	DLE	10	D _L
CTRL Q	DC1	11	D ₁
CTRL R	DC2	12	D ₂
CTRL S	DC3	13	D ₃
CTRL T	DC4	14	D ₄
CTRL U	NAK	15	N _K
CTRL V	SYN	16	S _Y
CTRL W	ETB	17	E _B
CTRL X	CAN	18	C _N
CTRL Y	EM	19	E _M
CTRL Z	SUB	1A	S _B

Appendix D Continued

Code	ASCII	Hex	Character Displayed
CTRL [ESC	1B	E _C
CTRL \	FS	1C	F _X
CTRL]	GS	1D	G _X
CTRL ^	RS	1E	R _S
CTRL _	US	1F	U _S
DEL	DEL	7F	⌘

Appendix E Cursor Coordinates

Row/ Column	ASCII Code Transmitted	Row/ Column	ASCII Code Transmitted	Row/ Column	ASCII Code Transmitted
1	Space	28	;	55	V
2	!	29	<	56	W
3	"	30	=	57	X
4	#	31	>	58	Y
5	\$	32	?	59	Z
6	%	33	@	60	[
7	&	34	A	61	\
8	'	35	B	62]
9	(36	C	63	^
10)	37	D	64	_
11	*	38	E	65	`
12	+	39	F	66	a
13	,	40	G	67	b
14	-	41	H	68	c
15	.	42	I	69	d
16	/	43	J	70	e
17	0	44	K	71	f
18	1	45	L	72	g
19	2	46	M	73	h
20	3	47	N	74	i
21	4	48	O	75	j
22	5	49	P	76	k
23	6	50	Q	77	l
24	7	51	R	78	m
25	8	52	S	79	n
26	9	53	T	80	o
27	:	54	U		

Appendix F Control Codes

Code	Function	Corresponding Key
CTRL G	Ring bell	
CTRL H	Cursor left	BACK SPACE ←
CTRL I	Tabulate to tab stop (typewriter, protect mode off; field, protect mode on)	TAB
CTRL J	Line feed	LINE FEED Shifted ↓
CTRL K	Cursor up	↑
CTRL L	Cursor right	→
CTRL M	Carriage return	RETURN ENTER
CTRL N	Disable X-On/X-Off; enable DTR line	
CTRL O	Enable X-On/X-Off; disable DTR line	
CTRL R	Bidirectional communication on	
CTRL T	Bidirectional communication off	
CTRL V	Cursor down ¹	↓
CTRL X	Clear current unprotected field to spaces	CE
CTRL Z	Clear all unprotected to spaces	CLEAR SPACE
CTRL ^	Cursor home	HOME
CTRL _	New line (carriage return and line feed)	

1. Depends on set up parameter for DOWN.

Appendix G Escape Sequences

Sequence	Function	Corresponding Key
ESC a	Buffered transparent print mode off	
ESC A	Buffered extension print mode off	
ESC b	Light background	
ESC B	Block mode on	
ESC C	Previous conversation mode on; block mode off	
ESC d	Dark background	
ESC D H	Half duplex mode on	
ESC D F	Full duplex mode on	
ESC E	Insert line	LINE INSERT
ESC f (text) CTRL Y	Program message line	
ESC F w h	Define block of attributes	
ESC g n	Assign logical attribute(s) to current field	
ESC G n	Define visual attribute(s)	
ESC H w h	Define block graphics area	
ESC i	Tabulate to next field tab stop (protect mode on)	
ESC I	Back tab (typewriter, protect mode off; field, protect mode on)	BACK TAB
ESC j	Reverse line feed	Shifted ↑
ESC J	View previous page	Shifted PAGE
ESC k 0	Duplex edit mode on	
ESC k 1	Local edit mode on	
ESC K	View next page	PAGE
ESC L p r c (text) CTRL Y	Send data to hidden cursor	
ESC M	Send terminal identification	
ESC N 1	Page edit mode on	
ESC N 0	Line edit mode on	
ESC o n	Logical attribute mode on/off	

Appendix G Continued

Sequence	Function	Corresponding Key
ESC p n	Send current/nonvolatile memory to computer	
ESC P n	Print page	PRINT Shifted PRINT
ESC Q	Insert space	CHAR INSERT
ESC R	Delete line	LINE DELETE
ESC s n	Define 25th line	
ESC S n	Define data to be sent	Shifted SEND
ESC t	Erase from cursor to end of line with nulls	Shifted LINE ERASE
ESC T	Erase from cursor to end of line with spaces	PAGE ERASE
ESC U	Monitor mode on	
ESC v 0	Autopage mode off	
ESC v 1	Autopage mode on	
ESC W	Delete character	
ESC X	Monitor mode off	
ESC y	Erase from cursor to end of page with nulls	
ESC Y	Erase from cursor to end of page with spaces	
ESC Z 2	Report values from set up lines	
ESC Z n	Send message/status line to computer	
ESC 0 m a b c	Reprogram editing key	
ESC 1	Set column of typewriter tab stops at cursor column (protect mode off) or field tab stops from cursor downward (protect mode on)	
ESC 2	Clear current typewriter tab stop	
ESC 3	Clear all typewriter tab stops	
ESC 8 1	Smooth scroll mode on	
ESC 8 0	Normal scroll mode on	
ESC * 0	Clear all to nulls	Shifted CLEAR SPACE
ESC * 1	Clear all to spaces	

Appendix G Continued

Sequence	Function
ESC * 2	Clear unprotected to nulls
ESC * 3	Clear unprotected to spaces
ESC ^ 0	Send answerback code
ESC @	Buffered extension print mode on
ESC `	Buffered transparent print mode on
ESC \ n	Define lines per page
ESC _ t b	Define scrolling region
ESC)	Write protect mode on
ESC (Write protect mode off
ESC &	Protect mode on
ESC '	Protect mode off
ESC - p r c	Address cursor (page, row, column)
ESC = r c	Address cursor (row and column)
ESC /	Read cursor (page, row, column)
ESC ?	Read cursor (row, column)
ESC ~ 0	Load nonvolatile memory with factory default values
ESC ~ 1	Reset terminal to set up/status line values
ESC } (codes)	Establish set up line values
ESC #	Lock keyboard
ESC ''	Unlock keyboard
ESC . 0	Invisible cursor
ESC . 1	Blinking block cursor
ESC . 2	Steady block cursor
ESC . 3	Blinking underline cursor
ESC . 4	Steady underline cursor
ESC < 1	Keyclick on
ESC < 0	Keyclick off

Appendix G Continued

Sequence	Function
ESC \$	Special graphics mode on; alphanumeric mode off
ESC %	Alphanumeric mode on; special graphics mode off
ESC { m p ₁ p ₂ p ₃ p ₄	Define port parameters
ESC x (code)	Define delimiter code
ESC ^ 1 (text) CTRL Y	Change answerback text
ESC] n (codes)	Reprogram all editing keys
ESC ! p ₁ p ₂ (message) CTRL Y	Reprogram function key

Appendix H Character Sets

Table H-1
Character Set Differences

Hex Code	US	UK	Germ	French	Span	Port	Dan/ Norw	Fin/ Swed
23	#	£	#	£	#	#	#	#
40	@	@	S	à	ı	S	@	É
5B	[[Ä	°	ñ	Å	Æ	Ä
5C	\	\	Ö	ç	i	Ç	Ø	Ö
5D]]	Ü	S	Ñ	Ö	Å	Å
5E	ˆ	ˆ	ˆ	ˆ	ˆ	ˆ	Ü	Ü
60	ˆ	ˆ	ˆ	ë	ˆ	ˆ	ˆ	é
7B	{	{	ä	é	{	ã	æ	ä
7C			ö	ü		ç	ø	ö
7D	}	}	ü	è	}	õ	å	å
7E	˘	˘	ß	ÿ	°	°	ü	ü

Figure H-1
US ASCII Keyboard Layout

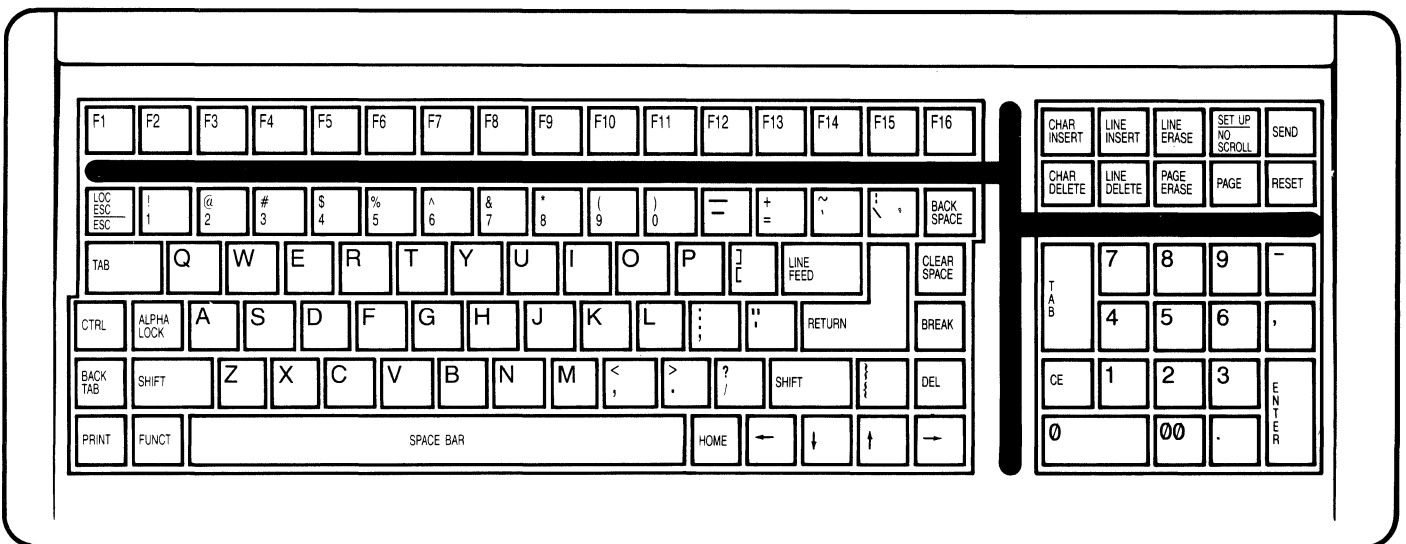

Appendix H Continued

Figure H-2
UK Keyboard Layout

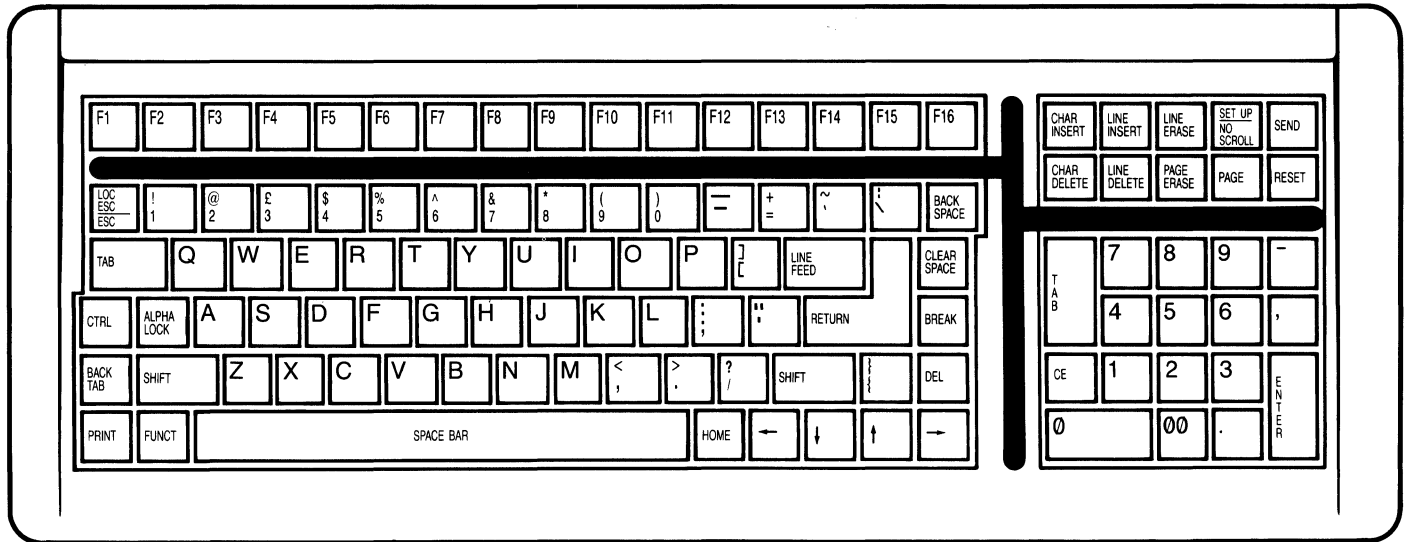
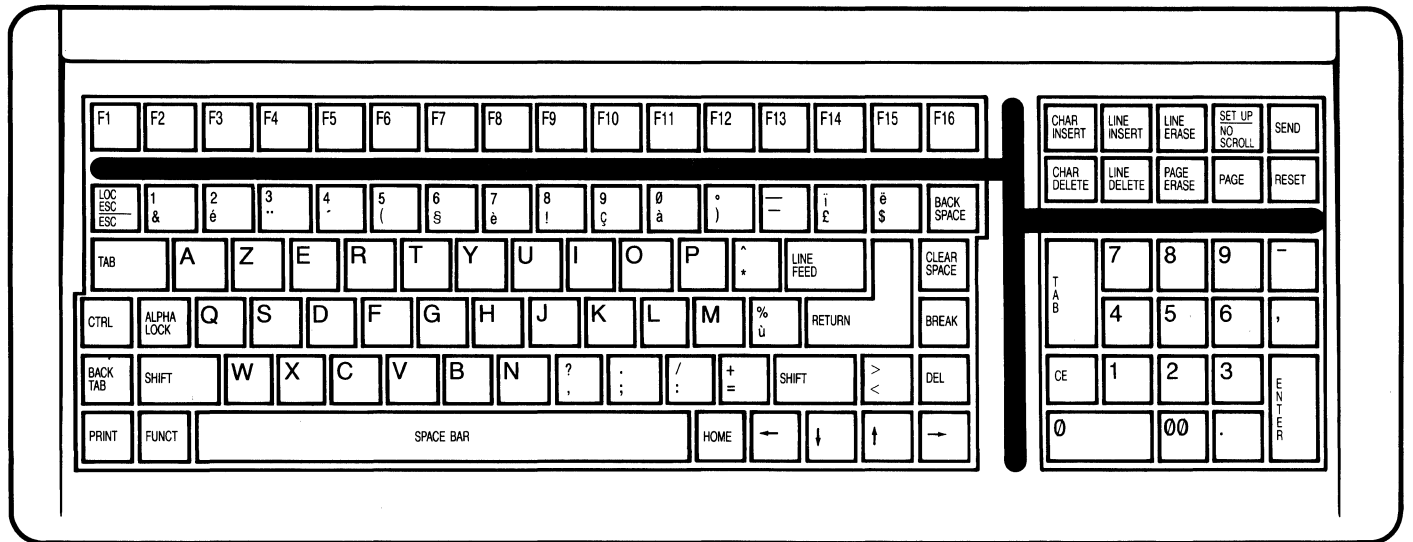

Figure H-3
French Keyboard Layout



NOTE! SEND and PRINT keys send accent code and lowercase vowel instead of the accented vowel characters.

Appendix H Continued

Figure H-4
German Keyboard Layout

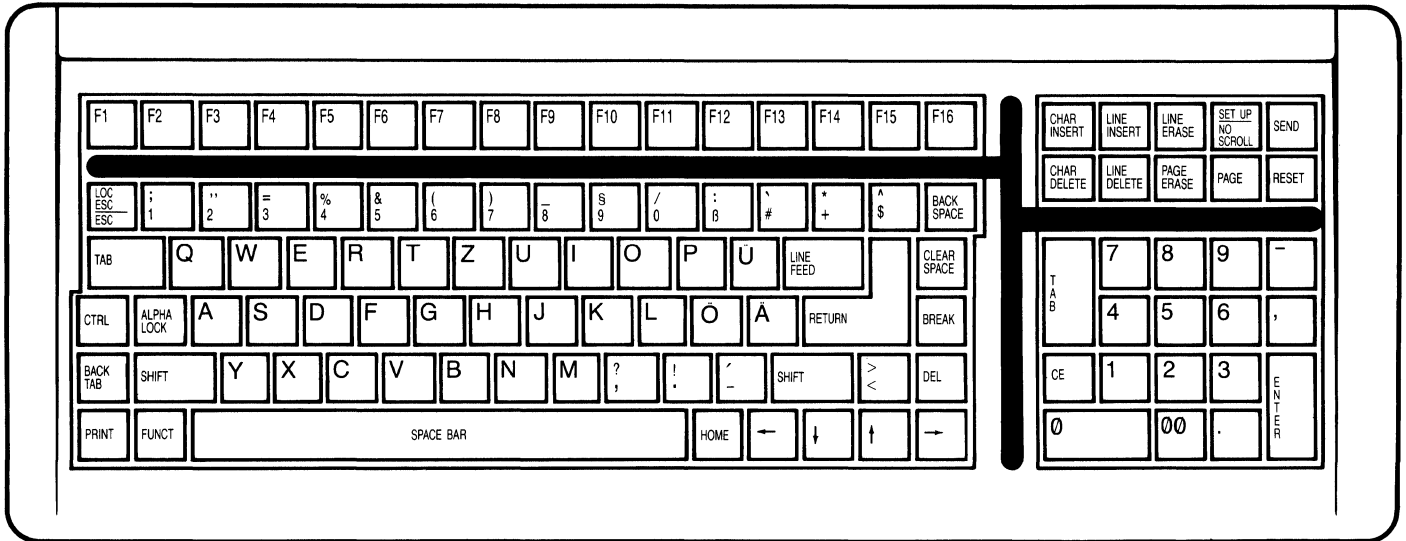
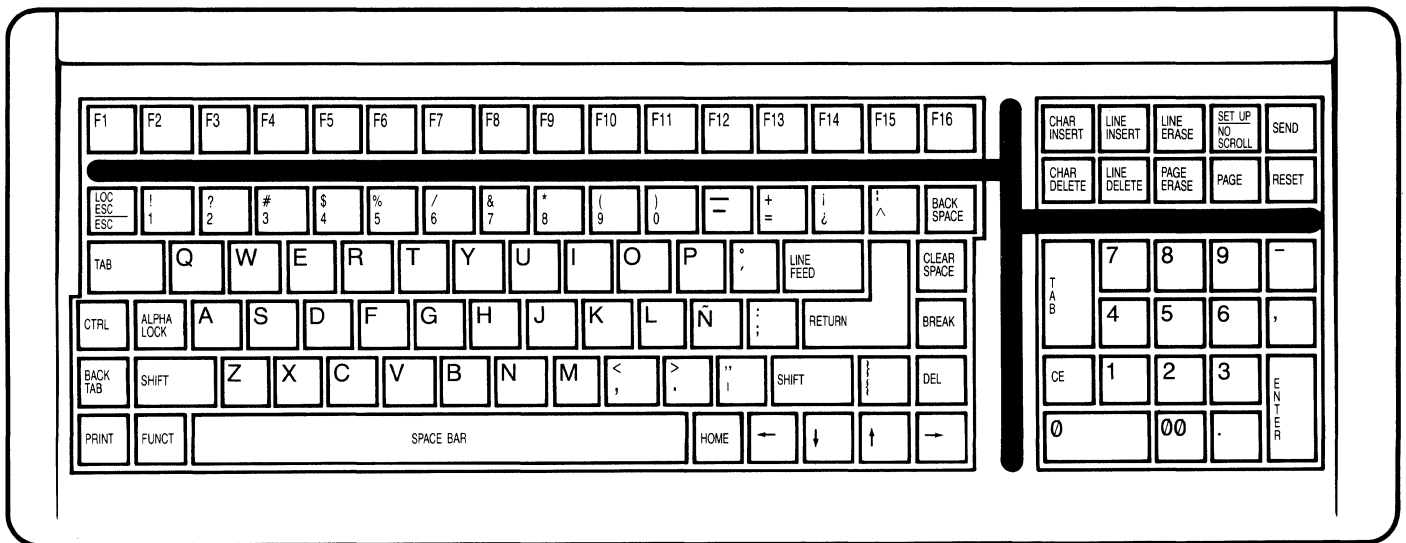

Figure H-5
Spanish Keyboard Layout



NOTE! SEND and PRINT keys send accent code and lowercase vowel instead of the accented vowel characters.

Appendix H Continued

Figure H-6
Finnish/Swedish Keyboard Layout

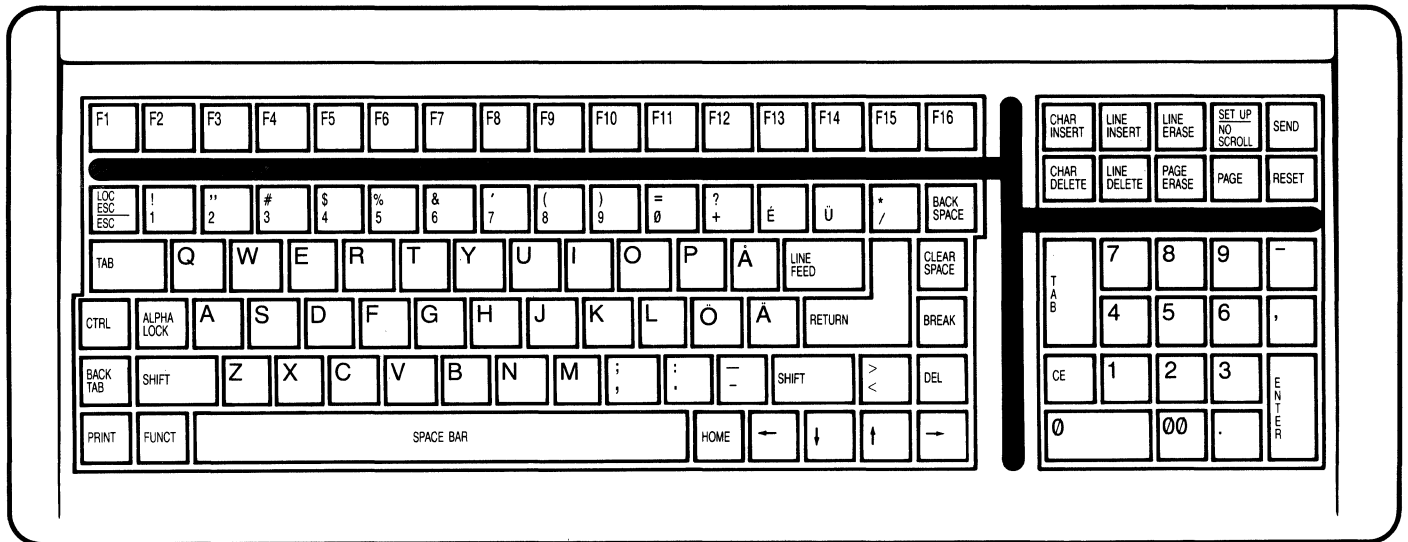
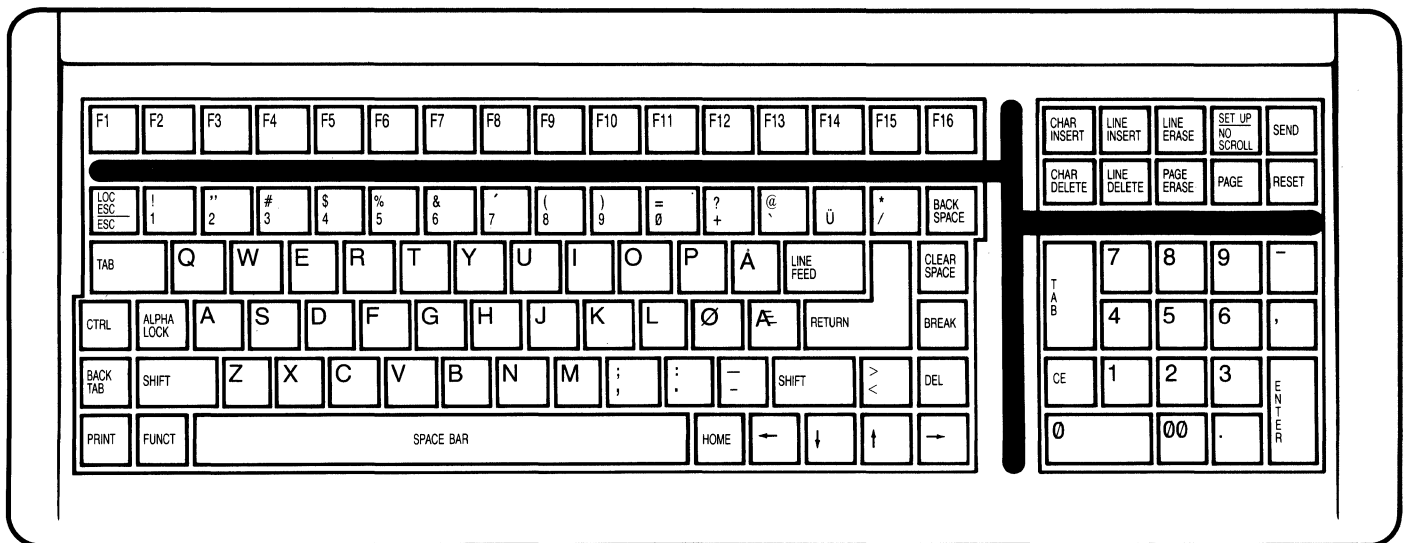
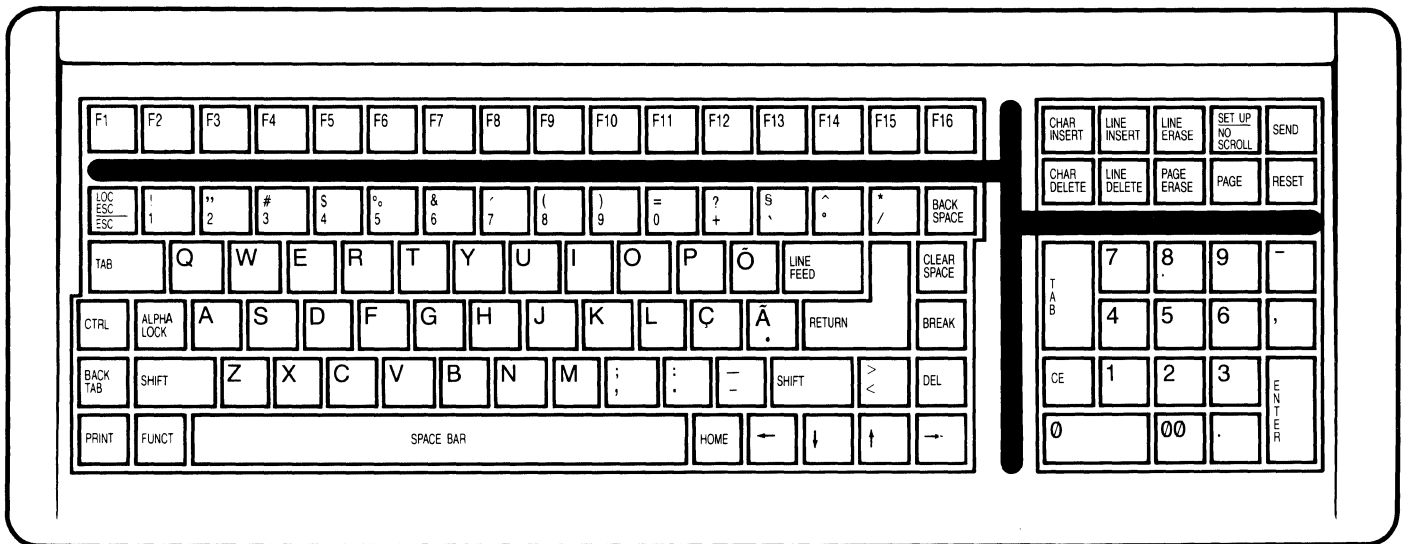

Figure H-7
Danish/Norwegian Keyboard Layout



Appendix H Continued

Figure H-8
 Portuguese Keyboard Layout



Appendix I Set Up Memory Bit Map

Table I-1
Set Up Memory Bit Map

Char-acter No.	Value	Bit 3 Name	Bit 2 Name	Bit 1 Name	Bit 0 Name
Communication Mode					
1	0	FDX	—	Line	Edit Key
	1	HDX	BLK	Page	DUPE LOCE
2	0	Autotab	Unused	Scroll Type	Scroll Rate
	1	Off		Normal	6 lines
3	0	Protocol	RETURN key	↓key	Must be 0
	1	X-On/Off	CR	CTRL V	
4	0	DTR	CR and LF	CTRL J	Time Out
	1				
Character Set					
See Table I-2					
5	0	Autopage	Autowrap	Status line	Keyclick
	1	Off	Off	Undisplayed	Off
6	0	On	On	Displayed	On
	1				
Cursor Attribute					
6	0	Must be 0	Displayed	Block	Blinking
	1		Invisible	Underline	Steady
Computer Port Baud Rate					
7	0	Must be 0	See Table I-3		
	1				
Computer Port Parity Bit					
8	0	Stop Bits	Send	Even	Word Length
	1	1	No	Odd	7 bits
9	0	2			8 bits
	1				
Printer Port					
9	0	Must be 0	See Table I-3		
	1				
Printer Port Parity Bit					
10	0	Stop Bits	Send	Even	Word Length
	1	1	No	Odd	7 bits
11	0	2			8 bits
	1				
Screen Contrast					
11	0	Refresh	Must be 0	Background	Screen Contrast
	1	60 Hz		Dark	See Table I-4
12	0	50 Hz		Light	
	1				
Screen Contrast					
See Table I-4					

Appendix I Continued

Table I-2
Character Set Bit Map

Language	Bit No.		
	3	2	1
US ASCII	0	0	0
UK	0	0	1
French	0	1	0
German	0	1	1
Spanish	1	0	0
Swedish/Finnish	1	0	1
Norwegian/Danish	1	1	0
Portuguese	1	1	1

Table I-3
Baud Rate Bit Map

Baud Rate	Bit No.		
	2	1	0
150	0	0	0
300	0	0	1
1200	0	1	0
1800	0	1	1
2400	1	0	0
4800	1	0	1
9600	1	1	0
19200	1	1	1

Table I-4
Contrast

Level	Bit No.				
	4	3	2	1	0
Dimmest	0	0	0	0	0
	0	0	0	0	1
Default	1	0	0	0	0
Brightest	1	1	1	1	1



Index

- ACK character, 99
- Addressing visible cursor, 67
- ALPHA LOCK key, 30, 114
- Alphanumeric mode, 50
- Answerback code
 - changing, 103
 - sending, 96
- Area attributes
 - see Logical attributes, 55
- Assistance, 118
- Attributes
 - 25th line, 45
 - block, 48
 - logical, 55, 57
 - screen, 45-46
 - visual, 45-48, 69, 85, 88
- Autopage mode, 21, 52, 54, 58, 63, 65, 72-74
- Autotab mode, 23, 73-74
- Autowrap mode, 20, 64

- BACK SPACE key, 31
- Back tab, 23, 52, 74
- BACK TAB key, 33, 77
- Background, 19, 45, 46
- Baud rate, 70, 99, 103
 - computer port, 16, 27
 - printer port, 18
- Beep, 7, 112
- Bell, 44, 55, 97
- Bidirectional communication, 18, 97, 99, 101
- Bit map
 - set up memory, 41, A-24
- Block
 - attributes, 48
 - graphics, 49
- Block mode, 17, 27, 37, 77, 88-89
- BREAK key, 30
- Break pulse, 30
- Buffer
 - print, 26, 87-88, 98
 - receive, 26, 87-88
- Buffered
 - extension print, 18, 26, 97
 - transparent print, 18, 26, 97

- Cable requirements, 5
- CE (CLEAR ENTRY) key, 77
- Changing data, 78
- CHAR DELETE key, 33, 77
- CHAR INSERT key, 33, 77
- Character
 - sets, 23, 45, A-18
 - space, 33, 35
- Characters
 - special graphics, 49, 50

- CLEAR ENTRY key, 33
- CLEAR SPACE key, 33, 77
- Clearing
 - data, 78, 85
 - tab stops, 77
- Commands
 - incorporating, 39
- Communication
 - bidirectional, 18, 97, 99, 101
 - modes, 17, 27, 36, 70
- Composite video option, 8
 - installing, 12
- Computer busy, 26
- Computer port
 - configuring, 16, 102
- Configuration procedures
 - summary of, 28
- Contrast
 - screen, 16, 26
- Control codes, 114
 - displaying, 39
- Control character
 - displaying, 39
- Conversational modes, 77
- Copy print
 - See Extension print mode, 18, 26, 97
- Cover
 - removing/reinstalling, 1
- CR character, 22, 62, 70, 88, 97
- CRT
 - charges, 1, 114
 - inspecting, 2
- CTRL key, 30
- CTRL RESET key, 35, 40, 44, 112
- Current loop
 - configurations, 10
 - installing, 10
 - interface, 5
- Cursor
 - absence of, 112
 - addressing, 52, 67
 - appearance, 7, 113
 - control, 36
 - coordinate table, 49
 - hidden, 69
 - movement, 20, 49, 52, 55, 58, 62, 71, 85, 89
 - in set up lines, 16, 26
 - position, 26, 52
 - reading, 68
 - styles, 22, 44
- Cursor down, 62
- CURSOR DOWN key, 22, 33, 77
- Cursor left, 62 CURSOR LEFT key, 33, 77
- Cursor right, 62 CURSOR RIGHT key, 34, 77
- Cursor up, 62

Index Continued

- CURSOR UP key, 33, 77
- Customer Service department, 118
- Damage from shipping, 1
- Data
 - changing, 78
 - clearing, 78, 85
 - deleting, 78, 79
 - erasing, 78, 79
 - flow, 36
 - loss of, 51, 58, 59, 78, 79
 - movement, 53-54
 - preventing entry, 44
 - preventing loss of, 87
 - sending, 37, 88
- Data bits
 - computer port, 16
 - printer port, 18
- Data Terminal Ready (DTR), 17, 87, 88, 101
- Default
 - delimiters, 88
 - factory values, 40
- Defined scrolling region, 48, 49, 51, 54, 58, 68, 79
- DEL key, 31
- Delete commands, 78, 79
- Delimiters, 88
- Display
 - controlling the, 45
 - definition of, 51
 - flipping, 52
 - lines per, 45
 - wavy, 113
- Dividing memory, 51
- Duplex communication modes, 17, 27, 36, 70, 77, 88
- Duplex edit mode, 22, 27, 77
- Edit
 - boundaries, 23, 27
 - key modes, 22, 27, 38, 39, 77
 - modes, 23, 29, 38, 39, 77
- Editing
 - commands, 79
 - keys, 22, 27, 38, 39, 77
- Embedded visual attributes, 47
- ENTER key, 34, 77
- Erase commands, 78, 79
- ESC key, 31
- Escape sequences, 39, 114
- ETX character, 88
- Extension print mode, 18, 26, 97
- Factory default values, 40
- Field modifications, 8
- Field tab stops, 58, 70, 72
 - clearing, 77
 - setting, 71
- Flip
 - see Autopage, 21
- Form
 - creating protected, 57
 - protecting, 58
- Formatted page print, 26, 97, 99-101
- FS character, 88
- Full duplex mode, 17, 27, 36-38, 70, 77, 88, 113
- FUNCT key, 30, 70
- Function keys, 31, 69
 - reprogramming, 106
- Fuse
 - line, 117
 - neutral, 5
 - power supply, 116
- Graphics
 - block, 49
 - see Special graphics mode, 50
- Half duplex mode, 17, 27, 36-38, 70, 77, 88, 113
- Half intensity, 47, 71
- Handshaking protocols, 17, 70, 87-88, 101
- Hertz setting, 4, 19, 113
- Hidden cursor, 58, 69
- HOME key, 34, 77
- Home position, 62
- Identification, 96
- Insert commands, 78, 79
- Inspection, 1, 114
- Installation
 - summary, 14
 - terminal, 3
- Intensity of visual attributes, 47
- Interface
 - cables, 5
 - current loop, 10
- Jump scroll
 - see Normal scroll, 19, 53
- Key
 - ALPHA LOCK, 30, 114
 - BACK SPACE, 31
 - BACK TAB, 33, 77
 - BREAK, 30
 - CE (CLEAR ENTRY), 33, 77
 - CHAR DELETE, 33, 77
 - CHAR INSERT, 33, 77
 - CLEAR SPACE, 33, 77

Index Continued

- CTRL, 30 CTRL RESET, 19, 44
- CURSOR DOWN, 33
- CURSOR LEFT, 33
- CURSOR RIGHT, 34
- CURSOR UP, 33
- DEL, 31
- ENTER, 34, 77
- ESC, v, 31
- FUNCT, 30, 70
- HOME, 34, 77
- LINE DELETE, 34, 77
- LINE ERASE, 34, 77
- LINE FEED, 31
- LINE INSERT, 34, 77
- LOC ESC, 31, 39
- NO SCROLL, 32
- PAGE, 34, 77
- PAGE ERASE, 34, 77
- PRINT, 34, 38, 77, 97
- RESET, 35
- RETURN, 22, 32
- SEND, 35, 37, 77, 88
- SET UP, 15, 25, 32
- SHIFT, 30
- space bar, 32
- TAB, 35, 77
- Keyboard
 - cable, 113
 - connecting, 3
 - description, 29
 - lock/unlock, 26, 44, 113
- Keyclick, 21, 44, 97
- Keys
 - character, 29
 - editing, 39
 - effect of editing, 77
 - function, 31, 69
 - programmable, 69
 - repeat action, 29
 - specialized, 29
- LF character, 97
- Limited warranty, A-5
- Line
 - 25th, 45
 - fuse, 117
- LINE DELETE key, 34, 77
- Line edit mode, 23, 27, 78
- LINE ERASE key, 34, 77
- Line feed code, 22, 52, 58, 62
- LINE FEED key, 31, 34
- LINE INSERT key, 34, 77
- Lines per page, 50, 52
- LOC ESC key, 31, 39
- Local edit mode, 22, 27, 38, 39, 77
- Lock/unlock keyboard, 44, 113
- Logic board
 - removing/reinstalling, 8, 114
- Logical attributes, 55, 57
- Main
 - see Computer, 5
- Markers, 88
- Memory, 50
 - adding, 8, 12
 - clearing, 51
 - set up, 41
 - space, 52
- Message line, 19, 45, 97
 - appearance, 46
 - clearing, 46
 - programming, 46, 109
- Mode
 - alphanumeric, 50
 - autopage, 21, 52, 54, 58, 63, 65, 72-74
 - autotab, 23, 73-74
 - autowrap, 20, 64
 - block, 17, 27, 37, 77, 88-89
 - buffered extension print, 18, 36, 97
 - buffered transparent print, 18, 36, 97
 - conversational, 77
 - full duplex, 17, 27, 36-38, 70, 77, 88
 - half duplex, 17, 27, 36-37, 70, 77, 88
 - local edit, 22, 27, 38-39, 77
 - monitor, 26, 39
 - normal scroll, 53
 - protect, 49, 50, 52, 55, 57, 58, 63, 71, 72, 73, 74, 77, 79, 85, 88
 - smooth scroll, 53, 87
 - special graphics, 50
 - write protect, 57, 69, 79, 85
- Modes, 29
 - communication, 70
 - edit key, 27
 - line/page edit, 23, 27, 78
 - local/duplex edit, 22, 27, 38-39, 77
 - monitor, 26, 39
 - print, 18, 26, 97
- Monitor
 - adding, 8, 12
 - mode, 26, 39
- New line, 62
- NO SCROLL key, 32
- Nonvolatile memory, 15
 - erasing, 40
 - resetting, 40
 - set up bit map, 41, A-24
- Normal scroll mode, 19, 53
- Null characters, 97
- Options
 - additional memory, 8
 - composite video (monitor), 8
 - current loop, 8

Index Continued

- Page
 - changing displayed, 52
 - definition of, 51
 - length, 54
- Page edit mode, 23, 27, **78**
- PAGE ERASE key, **34, 77**
- PAGE key, **34, 77**
- Page print, 26, **38, 97**
- Pages
 - number of, 51
- Parity, 113
 - computer port, 17, 102
 - printer port, 18, 102
- Pin connector assignments, 5, 6
- Ports
 - see Computer and Printer, 5
- Power
 - configuration, 4, 19
 - requirements, 4
 - supply fuses, 116
- Power on/off, 40, 44
 - effect of, 15
- Power select switch, 4
- Print
 - modes, 18, 26, 97
 - page, 26, **38, 97**
- Print buffer, 98, 101
- PRINT key, **34, 38, 77, 97**
- Print modes, 18, 26, **97**
- Printer
 - configuring, 18, 102
 - connecting, 6
 - port, 5
- Printer busy, 26
- Printer Handshaking Protocols, 101
- Printing, 36, **38, 114**
 - incorrect, 113
- Programming the terminal, 39, 102
- Protect forms mode, 35, **55**
- Protect mode, 20, 26, 35, 49, 50, 52, 55, 57-58, 63, 71-74, 77, 79, 85, 88
- Protected data
 - clearing, 85
- Reading cursor, 68
- Receive buffer, 26, **87-88**
- Receive data control, 17
- Reconfiguration
 - methods, 15
 - summary, 27
- RESET key, 35
- Resetting terminal, 27, **40**
- Reshipping, 118
- RETURN key, 22, **32**
- Return Material Authorization (RMA), A-5
- Reverse line feed, 52, **58, 63**
- RS-232C port
 - connector assignments, 5-6
- Screen
 - attributes, 45-46
 - background, 19, 45, **46**
 - contrast, 16, 26
 - definition of, 51
 - display, 45,
 - memory, 8, 12, 50
 - refresh rate, 19
 - saver, 19
 - updating, 54, 99
- Scrolling, 52
 - effect, 53
 - movement, 53
 - rate, **19, 53**
 - region, 48-49, 51, 54, 58, 68, 79
 - types, 19
- Send
 - answerback code, 96
 - message line, 97
 - status line, 97
- SEND key, 35, 37, 77, 88
- Sending
 - data, 26, **88**
 - to hidden cursor, 69
 - protected, 88
 - unprotected, 88
- Serial printer, 6
- Service calls, 111
- Set transmit state, 35
- Set up lines, 15, 45
 - changing, 15, 16, 44
 - values, 15-16, 18, 42
- set up memory, 41
- set up mode, 15-16, 26, 53, 113
- SET UP key, 15, 25, **32**
- SHIFT key, 30
- Shroud, 8, 114
- Site requirements, 2
- Smooth scroll mode, 19, 53, 87
- SOH character, 70
- Space
 - bar key, 32
 - character, 33, 35
- Special graphics
 - characters, 49, 50, 88, 97
 - mode, 50
- Status line, 15, 19, 25, 40, 45, 78, 97
- Stop bits, 17-18, 103, 113
- STX character, 88
- Summary
 - configuration procedures, 28
 - installation, 14
 - reconfiguration methods, 27
- System response, 113

Index Continued

- TAB keys, 35, 77
- Tab stops
 - clearing, 77
 - field, 58, 72
 - setting, 71
 - types, 70
 - typewriter, 72, 87
- Tabulation, 23, 52
 - backward, 74
- Technical assistance, 118
- Terminal
 - adjusting tilt, 8
 - beep, 7
 - bell, 44
 - buffers, 26, 87-88, 98, 101
 - contrast, 28
 - controls, 39
 - current configuration, 42
 - dead, 112
 - factory default values, 16, 18
 - identification, 96
 - inspecting, 1, 114
 - installing, 3
 - on-line, 113
 - opening, 8, 114
 - pages, 50
 - plugging in, 7
 - power requirements, 4
 - programming, 39
 - reconfiguring, 15
 - removing cover, 1
 - resetting, 40
 - reshipping, 118
 - screen, 19
 - site selection, 2
 - specifications, A-3
 - turning on, 7
- Terminal busy, 26
- Transmission, 88
 - block, 37
- Transmit state, 35
- Transmitting data, 26, 37, 69, 88
- Transparent print mode, 18, 26, 97
- Troubleshooting, 111
- Twenty-fifth line, 19, 45
 - display, 45
- Typewriter tab stops, 71-72, 77, 87

- Unformatted page print, 26, 38, 97
- Unprotected data, 85
- US character, 88

- Visible cursor, 67-68, 71
- Visual attributes, 33, 45-48, 69, 85, 88

- Warranty, limited, A-5

- Word structure, 103, 113
 - computer port, 16
 - printer port, 18
- Write protect mode, 27, 57, 69, 79, 85
- Write-protected fields, 71, 88

- X-On/X-Off, 17, 26, 87, 101, 114

Quick Reference Guide

Function	Key	Function	Command
RECONFIGURATION (page 27)		Full intensity normal video	ESC G 0
Load status line with nonvolatile memory; disable no scroll, print, write protect, protect modes	CTRL shifted BREAK	Full intensity invisible video	ESC G 1
Reset status line with set up/nonvolatile values	CTRL RESET	Full intensity blinking video	ESC G 2
	Command	Full intensity invisible blinking video	ESC G 3
		Full intensity reverse background	ESC G 4
		Full intensity invisible reverse background	ESC G 5
		Full intensity blinking reverse background	ESC G 6
MONITOR MODE (page 39)		Full intensity invisible blinking reverse background	ESC G 7
Monitor mode on	ESC U	Full intensity underline	ESC G 8
Monitor mode off	ESC X	Full intensity invisible underline	ESC G 9
		Full intensity blinking underline	ESC G :
RESETTING THE TERMINAL (page 40)		Full intensity invisible blinking underline	ESC G ;
Reset nonvolatile memory to factory default values	ESC ~ 0	Full intensity reverse underline	ESC G <
Reset terminal to set up/status line values	ESC ~ 1	Full intensity invisible reverse underline	ESC G =
Establish set up line values	ESC } {codes}	Full intensity reverse blinking underline	ESC G >
Report values from set up lines	ESC Z 2	Full intensity invisible reverse blinking underline	ESC G ?
Send message line to computer	ESC Z 0	Half intensity normal video	ESC G sp
Send status line to computer	ESC Z 1	Half intensity invisible video	ESC G !
Send terminal configuration to computer	ESC p 0	Half intensity blinking video	ESC G "
Send nonvolatile memory to computer	ESC p 1	Half intensity invisible blinking video	ESC G #
		Half intensity reverse background	ESC G \$
LOCKING/UNLOCKING THE KEYBOARD (page 44)		Half intensity invisible reverse background	ESC G %
Lock keyboard	ESC #	Half intensity blinking reverse background	ESC G &
Unlock keyboard	ESC "	Half intensity invisible blinking reverse background	ESC G '
CURSOR STYLE (page 44)		Half intensity underline	ESC G (
Invisible cursor	ESC . 0	Half intensity invisible underline	ESC G)
Blinking block cursor	ESC . 1	Half intensity blinking underline	ESC G *
Steady block cursor	ESC . 2	Half intensity invisible blinking underline	ESC G +
Blinking underline cursor	ESC . 3	Half intensity reverse underline	ESC G ,
Steady underline cursor	ESC . 4	Half intensity invisible reverse underline	ESC G -
KEYCLICK AND BELL (page 44)		Half intensity reverse blinking underline	ESC G .
Keyclick on	ESC < 1	Half intensity invisible reverse blinking underline	ESC G /
Keyclick off	ESC < 0	Define block of attributes	ESC F w h
Ring bell	CTRL G	Define block graphics area	ESC H w h
DISPLAY CONTROLS (page 45)		Special graphics mode on;	ESC \$
Define 25th line as blank	ESC s 0	alphanumeric mode off	
Define 25th line as message line	ESC s 1	Special graphics mode off;	ESC %
Define 25th line as status line	ESC s 2	alphanumeric mode on	
Program message line	ESC f {text}		
	CTRL Y		
Turn screen on	ESC n 0		
Turn screen off	ESC n 1		
Light background	ESC b		
Dark background	ESC d		

Quick Reference Guide Continued

Function	Command
ADDITIONAL SCREEN MEMORY (Page 50)	
Define memory as 4 24-line pages	ESC \ 1
Define memory as 2 48-line pages	ESC \ 2
Define memory as 1 96-line page	ESC \ 3
Autopage mode on	ESC v 1
Autopage mode off	ESC v 0
Move to next page	ESC K
Move to previous page	ESC J
Smooth scroll mode on	ESC 8 1
Normal scroll mode on	ESC 8 0
Define scrolling region	ESC _ t b

CREATING PROTECTED FORMS (page 55)	
Logical attribute allows only alphabetic entries	ESC g 1
Logical attribute allows only numeric entries	ESC g 2
Logical attribute requires data entry alphabetic entry	ESC g 4
Logical attribute requires alphabetic entry	ESC g 5
Logical attribute requires numeric entry	ESC g 6
Logical attribute requires total data fill	ESC g 8
Logical attribute requires total fill with alphanumeric characters	ESC g 9
Logical attribute requires total fill with numeric characters	ESC g :
Logical attribute mode off	ESC o 0
Logical attribute mode on	ESC o 1
Write protect mode on	ESC)
Write protect mode off	ESC (
Protect mode on	ESC &
Protect mode off	ESC '

CURSOR CONTROL (page 58)	
Line feed	CTRL J
Reverse line feed	ESC j
Cursor up	CTRL K
Cursor down	CTRL V
Cursor left	CTRL H
Cursor right	CTRL L
Carriage return	CTRL M
Cursor home	CTRL ^
New line (carriage return and line feed)	CTRL _

ADDRESSING AND READING THE CURSOR (page 67)	
Address cursor to page, row, column	ESC - p r c
p = Page	
0 One	
1 Two	
2 Three	
3 Four	

Function	Command
Address cursor to row and column	ESC = r c
Read cursor on page, row, column	ESC /
Read cursor row, column	ESC ?
Send data to hidden cursor	ESC L p r c
p = Page	(text)
0 One	CTRL Y
1 Two	
2 Three	
3 Four	

TAB STOPS (page 70)	
Set column of typewriter tab stops at cursor column (protect mode off) or field tab stops from cursor downward (protect mode on)	ESC 1
Tabulate to tab stop (typewriter, protect mode off; field, protect mode on)	CTRL I
Tabulate to next field tab stop (protect mode on)	ESC i
Back tab (typewriter, protect mode off; field, protect mode on)	ESC I
Clear current typewriter tab stop at cursor	ESC 2
Clear all typewriter tab stops	ESC 3

COMMUNICATION MODES (page 77)	
Block mode on	ESC B
Half duplex mode on	ESC D H
Full duplex mode on	ESC D F
Previous conversation mode on; block mode off	ESC C

EDIT MODES (page 77)	
Local edit mode on	ESC k 1
Duplex edit mode on	ESC k 0

CHANGING DATA (page 78)	
Page edit mode on	ESC N 1
Line edit mode on	ESC N 0
Insert space character	ESC Q
Delete character	ESC W
Insert line of spaces	ESC E
Delete line	ESC R
Erase to end of line with spaces	ESC T
Erase to end of line with nulls	ESC t
Erase to end of page with spaces	ESC Y
Erase to end of page with nulls	ESC y

Model 924

Video Display Terminal

Quick Reference Guide

Function	Key	Function	Command
RECONFIGURATION (page 27)			
Load status line with nonvolatile memory; disable no scroll, print, write protect, protect modes	CTRL shifted BREAK	Half intensity blinking reverse background	ESC G &
Reset status line with set up/nonvolatile values	CTRL RESET	Half intensity invisible blinking reverse background	ESC G ^
	Command	Half intensity underline	ESC G (
		Half intensity invisible underline	ESC G)
		Half intensity blinking underline	ESC G *
		Half intensity invisible blinking underline	ESC G +
MONITOR MODE (page 39)			
Monitor mode on	ESC U	Half intensity reverse underline	ESC G ,
Monitor mode off	ESC X	Half intensity invisible reverse underline	ESC G -
		Half intensity reverse blinking underline	ESC G .
		Half intensity invisible reverse blinking underline	ESC G /
RESETTING THE TERMINAL (page 40)			
Reset nonvolatile memory to factory default values	ESC ~0	Define block of attributes	ESC F w h
Reset terminal to set up/status line values	ESC ~1	Define block graphics area	ESC H w h
Establish set up line values	ESC } (codes)	Special graphics mode on; alphanumeric mode off	ESC \$
Report values from set up lines	ESC Z 2	Special graphics mode off; alphanumeric mode on	ESC %
Send message line to computer	ESC Z 0	ADDITIONAL SCREEN MEMORY (Page 50)	
Send status line to computer	ESC Z 1	Define memory as 4 24-line pages	ESC \ 1
Send terminal configuration to computer	ESC p 0	Define memory as 2 48-line pages	ESC \ 2
Send nonvolatile memory to computer	ESC p 1	Define memory as 1 96-line page	ESC \ 3
		Autopage mode on	ESC v 1
		Autopage mode off	ESC v 0
		Move to next page	ESC K
		Move to previous page	ESC J
		Smooth scroll mode on	ESC 8 1
		Normal scroll mode on	ESC 8 0
		Define scrolling region	ESC _ t b
LOCKING/UNLOCKING THE KEYBOARD (page 44)			
Lock keyboard	ESC #	CREATING PROTECTED FORMS (page 55)	
Unlock keyboard	ESC "	Logical attribute allows only alphabetic entries	ESC g 1
		Logical attribute allows only numeric entries	ESC g 2
		Logical attribute requires data entry	ESC g 4
		Logical attribute requires alphabetic entry	ESC g 5
		Logical attribute requires numeric entry	ESC g 6
		Logical attribute requires total data fill	ESC g 8
		Logical attribute requires total fill with alphanumeric characters	ESC g 9
		Logical attribute requires total fill with numeric characters	ESC g :
		Logical attribute mode off	ESC o 0
		Logical attribute mode on	ESC o 1
		Write protect mode on	ESC (
		Write protect mode off	ESC &
		Protect mode on	ESC ^
		Protect mode off	
DISPLAY CONTROLS (page 45)			
Define 25th line as blank	ESC s 0	CURSORS CONTROL (page 58)	
Define 25th line as message line	ESC s 1	Line feed	CTRL J
Define 25th line as status line	ESC s 2	Reverse line feed	ESC j
Program message line	ESC f	Cursor up	CTRL K
		Cursor down	CTRL V
		Cursor left	CTRL H
		Cursor right	CTRL L
		Carriage return	CTRL M
		Cursor home	CTRL ^
		New line (carriage return and line feed)	CTRL _
Turn screen on	CTRL Y		
Turn screen off	ESC n 1		
Light background	ESC b		
Dark background	ESC d		
Full intensity normal video	ESC G 0		
Full intensity invisible video	ESC G 1		
Full intensity blinking video	ESC G 2		
Full intensity invisible blinking video	ESC G 3		
Full intensity reverse background	ESC G 4		
Full intensity invisible reverse background	ESC G 5		
Full intensity blinking reverse background	ESC G 6		
Full intensity invisible blinking reverse background	ESC G 7		
Full intensity underline	ESC G 8		
Full intensity invisible underline	ESC G 9		
Full intensity blinking underline	ESC G ;		
Full intensity invisible blinking underline	ESC G ;		
Full intensity reverse underline	ESC G <		
Full intensity invisible reverse underline	ESC G =		
Full intensity reverse blinking underline	ESC G >		
Full intensity invisible reverse blinking underline	ESC G ?		
Half intensity normal video	ESC G sp		
Half intensity invisible video	ESC G !		
Half intensity blinking video	ESC G "		
Half intensity invisible blinking video	ESC G #		
Half intensity reverse background	ESC G \$		
Half intensity invisible reverse background	ESC G %		

Quick Reference Guide

Function	Command	Function	Command
ADDRESSING AND READING THE CURSOR (page 67)			
Address cursor to page, row, column	ESC - p r c	Send page up to and including cursor	ESC S 7
p = Page		Send unprotected message between STX and ETX	ESC S 9
0 One		Send protected message between STX and ETX	ESC S :
1 Two		Send message between STX and ETX	ESC S ;
2 Three		Send form	ESC S ?
3 Four		Send terminal identification	ESC M
Address cursor to row and column	ESC = r c	Send answerback code	ESC ^ 0
Read cursor on page, row, column downward (protect mode on)	ESC /	Send message line	ESC Z 0
Read cursor row, column	ESC ?	Send status line	ESC Z 1
Send data to hidden cursor	ESC L p r c (text)		
p = Page	CTRL Y		
0 One			
1 Two			
2 Three			
3 Four			
TAB STOPS (page 70)			
Set column of typewriter tab stops at cursor column (protect mode off) or field tab stops from cursor downward (protect mode on)	ESC 1	PRINTING (page 97)	
Tabulate to tab stop (typewriter, protect mode off; field, protect mode on)	CTRL I	Buffered extension print mode on	ESC @
Tabulate to next field tab stop (protect mode on)	ESC i	Buffered extension print mode off	ESC A
Back tab (typewriter, protect mode off; field, protect mode on)	ESC I	Buffered transparent print mode on	ESC ^
Clear current typewriter tab stop at cursor	ESC 2	Buffered transparent print mode off	ESC a
Clear all typewriter tab stops	ESC 3	Print formatted unprotected page	ESC P 1
		Print formatted protected page	ESC P 2
		Print formatted page	ESC P 3
		Print unformatted page	ESC P 4
		Bidirectional communication on	CTRL R
		Bidirectional communication off	CTRL R
		PORT CONTROL	
		Define port parameters	ESC { m p ₁ p ₂ p ₃ p ₄
		m Port	
		0 Computer	
		1 Printer port	
		p ₁ Baud Rate	
		0 150	
		1 300	
		2 1200	
		3 1800	
		4 2400	
		5 4800	
		6 9600	
		7 19200	
		p ₂ Word Length	
		0 7 bits	
		1 8 bits	
		p ₃ Parity	
		0 Even (receive/transmit)	
		1 Odd (receive/transmit)	
		2 No	
		p ₄ Stop Bits	
		0 1	
		1 2	
		DELIMITERS (page 103)	
		Define delimiter code	ESC x (code)
		ANSWERBACK MESSAGE (page 103)	
		Change answerback text	ESC ^ 1 (text) CTRL Y
		KEYS (page 104)	
		Reprogram one editing key	ESC 0 m a b c
		Reprogram all editing keys	ESC] n (codes)
		n Key	
		0 Unshifted	
		1 Shifted	
		Reprogram function key	ESC [p ₁ p ₂ (message) CTRL Y
		MESSAGE LINE (page 109)	
		Load message line	ESC f (text) CTRL Y

 **TeleVideo Systems, Inc.**

*1170 Morse Avenue
Sunnyvale, CA 94086*