

**TeleVideo
965
Operator's
Manual**

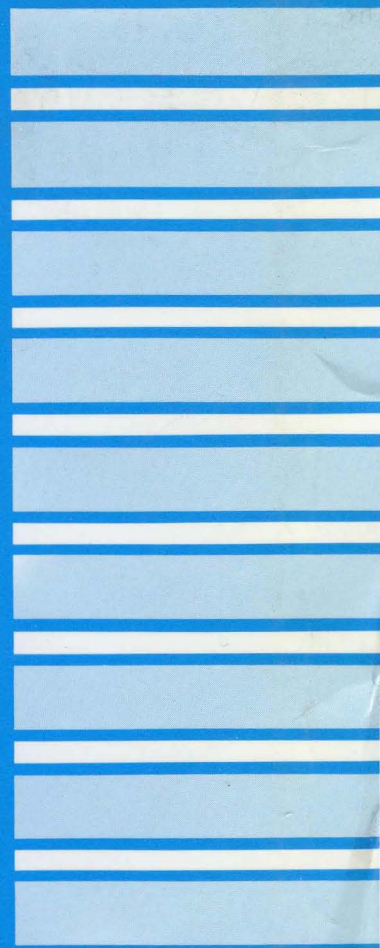

TELEVIDEO®
965 VIDEO DISPLAY TERMINAL
OPERATOR'S MANUAL

TeleVideo Document 133008-00-A
January 1988

Copyright

Copyright (c) 1988 by TeleVideo Systems, Inc. All rights reserved. No part of this publication may be reproduced, transmitted, transcribed, stored in a retrieval system, or translated into any language or computer language, in any form or by any means, electronic, mechanical, magnetic, optical, chemical, manual, or otherwise, without the prior written permission of TeleVideo Systems, Inc., 1170 Morse Ave., P.O. Box 3568, Sunnyvale, California 94088-3568.

Disclaimer

TeleVideo Systems, Inc. makes no representations or warranties with respect to this manual. Further, TeleVideo Systems, Inc. reserves the right to make changes in the specifications of the product described within this manual at any time without notice and without obligation of TeleVideo Systems, Inc. to notify any person of such revision or changes.

The following trademarks appear in this publication:
TeleVideo, 905, 910, 910+, 912, 920, 925, 950, 955, 965, and
VideoDesk -- TeleVideo Systems, Inc.
WordStar -- MicroPro International Corp., Inc.
ADDS A2 -- Applied Digital Data Systems, Inc.
ADM 3A/5/31 -- Lear Siegler, Inc.
Hazeltine 1500 -- Hazeltine Corp.
DG200 -- Data General Corp.
WY-60, WY-50, WY-50+ -- Wyse Technology, Inc.

**TeleVideo Systems, Inc., 1170 Morse Ave., P.O. Box 3568,
Sunnyvale, California 94088-3568 408/745-7760**

FCC Class A Warning

This device is classified as a Class A computing device. Class A devices may only be used in commercial, business, or industrial environments. This equipment generates, uses, and can radiate radio frequency energy. If not installed and used in accordance with the instruction manual, it may cause interference with radio emissions. This equipment has been tested and found to comply with the limits for a Class A computing device, pursuant to Subpart J of Part 15 of FCC Rules, which are designed to provide reasonable protection against radio frequency interference (RFI) when operated in a commercial environment. Operation of this equipment in a residential area is likely to cause interference, in which case the user at his own risk and expense will be required to correct the interference. The use of nonshielded I/O cables may not guarantee compliance with FCC RFI limits.

TABLE OF CONTENTS

INTRODUCTION	vii
Meet the 965	vii
About This Manual	viii
PART I: OPERATION	
1 EVERYDAY OPERATION	
Starting Up	1.2
Display Controls	1.4
Resetting the Terminal	1.8
The Keyboard	1.9
Printer Port Controls	1.13
Host Port Communications	1.17
If a Problem Occurs	1.21
2 VIDEODESK	
General Information	2.2
The Clock	2.5
The Calendar	2.10
The Calculator	2.11
The ASCII Chart	2.15
3 SET-UP	
Review of the Set-Up Process	3.3
Parameter Menus	3.9
The Program Menus	3.25

PART II: PROGRAMMING

4 INTRODUCTION TO PROGRAMMING

Entering Commands	4.2
Personality Modes	4.5
Saving and Resetting Values	4.9

5 KEYBOARD AND SCREEN

The Keyboard	5.1
The Bell	5.4
Screen Appearance	5.5
Visual Attributes	5.7
Line Appearance	5.13
Test Displays	5.15

6 DISPLAY AND PAGE CONFIGURATION

Configuring Lines and Pages	6.1
The Split Screen	6.7
Page Movement Modes	6.10
Scrolling	6.12

7 EDITING AND CURSOR MOVEMENT

Editing Modes	7.1
Editing Data	7.8
Cursor Control	7.15
Tabulation	7.20

8 CHARACTER SETS

Selecting a Character Set	8.1
Designing Custom Characters	8.8
Block Graphics	8.15

9 DATA TRANSMISSION

Programming the Ports	9.1
Handshaking Protocols	9.4
Data Transmission Modes	9.6
Sending Text	9.9

10 REPROGRAMMING CODES AND MESSAGES

Key Configuration Modes	10.1
Editing and Numeric Keys	10.2
The Function Keys	10.4
The FUNCT Key	10.10
Information Lines	10.11
Terminal Identity Messages	10.15

PART III: INSTALLATION AND REFERENCE

11 INSTALLATION

Before You Start	11.1
Installation Steps	11.4
RS-232C Signal Assignments	11.10

APPENDICES

A	Specifications
B	Code and Character Sets
C	Command Summaries
D	Key Codes
E	Foreign Keyboards
F	Cursor Coordinates
G	Status Line Messages

INTRODUCTION

MEET THE 965

This manual describes the Revision A 965 terminal, a multi-personality video display terminal with a built-in desktop accessory program and an ASCII keyboard.

NOTE: This manual describes only the functions of the 965 Rev. A firmware. Should you receive this manual with a 965 terminal that contains Rev. B or above firmware, send back the manual order form that follows this section with a request for the correct manual. See the section in Chapter 1 titled "Running the Self Test" for instructions on how to determine your firmware revision level.

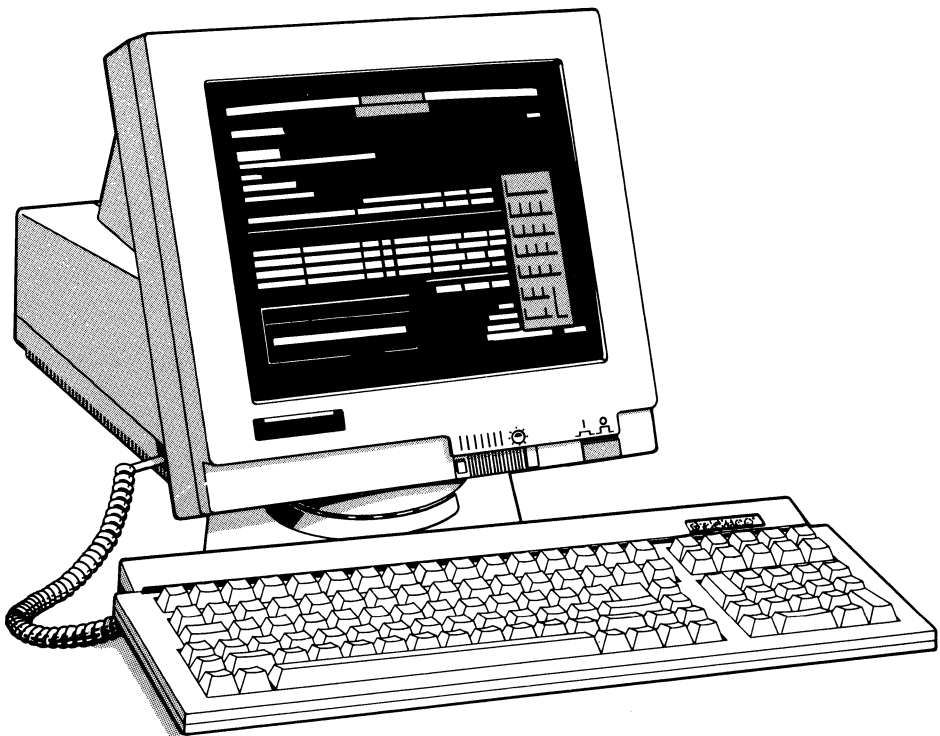

ABOUT THIS MANUAL

This manual has three parts:

Operation Daily operation, problem-solving, and set-up. Since the 965 is like no other terminal you've ever used, we urge you to read this portion of the manual. It's written to help you take best advantage of all the time- and work-saving features of the 965.

Programming Native-mode commands and some technical details about terminal operation.

Installation and Reference Step-by-step installation instructions, RS-232C signals, specifications, code tables, and operational references.

Attention, Please

This manual has three types of notices you should read carefully:

NOTE: Information of special interest or importance about a feature.

CAUTION! This procedure might destroy data or damage equipment. Make sure you read and understand thoroughly what you are doing before proceeding.

STOP! This procedure might cause you physical harm. Stop what you're doing and read instructions carefully before proceeding. Call a service technician, if necessary.

Ordering Other Publications

TeleVideo offers a maintenance manual for the 965 (PN 133007-00) and a free booklet showing how to incorporate terminal programming commands in a program written in BASIC (PN 113000-80). The maintenance manual is \$50, plus \$10 shipping.

To order the free programming booklet, check the box on the reader comment card included with this manual and mail it postage-free (in the USA) to TeleVideo. Mailing the card from outside the USA requires proper postage. Or contact TeleVideo at the phone numbers listed below and ask for the Literature Department.

To order the maintenance manual: In the USA or Canada, copy or tear out the order page following this section and fill it in. Send orders to:

TeleVideo Systems, Inc.	Svle:	408-745-7760
P.O. Box 3568	Telex:	474-5041
Sunnyvale, CA 94088-3568	Fax:	408-734-1927
Attn: Spare Parts Department	TWX:	910-338-7633

From Latin or South America, contact your distributor or use the order page. European customers should contact a European regional sales office to order a maintenance manual.

If you have any questions about ordering a manual, call the TeleVideo Spare Parts Department at the telephone numbers listed above, or your TeleVideo distributor or regional sales office.



NO POSTAGE
NECESSARY
IF MAILED
IN THE
UNITED STATES

BUSINESS REPLY MAIL
FIRST CLASS MAIL PERMIT NO. 1467 SUNNYVALE, CA

POSTAGE WILL BE PAID BY ADDRESSEE

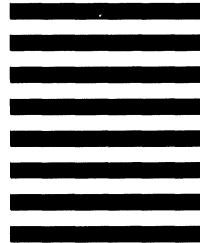

TeleVideo
1170 Morse Ave.
P.O. Box 3568
Sunnyvale, CA 94088-9980
Attn: Technical Publications



Please fold on dotted line

MANUAL ORDER FORM

Copy or tear out this page and fill in completely. Mail to the address below. If you have any questions, call the TeleVideo Spare Parts Department at 408/745-7760.

Name

Shipping address (street and number; we cannot ship to a P.O. box)

City/State/ZIP (U.S.)

Country

Please send _____ (quantity) maintenance manuals for
_____ (products) at \$60 each (\$50 plus \$10 shipping).

METHOD OF PAYMENT (check one)

- Charge account (established charge customers)

Account number _____

P.O. number _____

- Prepayment

Include check or money order for the amounts listed above, made out to **TeleVideo Systems, Inc.** Do not send cash.

- COD (U.S. only)

TeleVideo Systems, Inc.
Attn: Spare Parts Dept.
P.O. Box 3568
Sunnyvale, CA 94088-3568
U.S.A.

1 EVERYDAY OPERATION

Starting Up	1.2
Turning On the 965	1.2
Adjusting the Screen and Keyboard	1.3
Display Controls	1.4
Information Lines	1.5
Data Lines	1.7
Splitting the Screen	1.7
Number of Columns	1.7
Screen Saver	1.8
Resetting the Terminal	1.8
The Keyboard	1.9
Types of Keys	1.10
Local Key Operations	1.11
Printer Port Controls	1.13
Printer Port Modes	1.14
A Page Print	1.16
Host Port Communications	1.17
Host Port Communication Modes	1.17
Block Send	1.18
Editing Key Modes	1.19
Monitor Mode	1.19
If a Problem Occurs	1.21
Troubleshooting Checklist	1.21
Running the Self Test	1.23
If You Need Assistance	1.24

1 EVERYDAY OPERATION

This chapter tells how to operate the 965. It starts by showing how to turn on the terminal and adjust it for your comfort. Then come details on display features, the keyboard, printing, how the 965 communicates with a computer, and troubleshooting.

NOTE: The 965's desktop accessory program, VideoDesk, is explained in Chapter 2.

You will encounter frequent references to choosing operating values in *set-up* mode. Chapter 3 explains how you can control the terminal's operations in set-up mode.

The descriptions in this chapter apply when the 965 is off line. As soon as the terminal begins communicating with your computer, many of the functions described in this chapter can be changed by your operating system or an application program. If a feature described here does not operate as expected, contact your system manager or consult the manuals for your computer and application program.

If you suspect the terminal is not working properly, first look at the troubleshooting suggestions at the end of this chapter. Then if you need help, call your dealer or distributor.

NOTE: TeleVideo recommends that immediately after installation, before going on line, you enter set-up and perform a default reset. See Chapter 3 for instructions.

STARTING UP

This section assumes that the 965 is already installed. If the terminal is not yet installed, see Chapter 11, "Installation," for instructions.

Turning On the 965

To turn on the 965, press the on/off switch, as shown below.

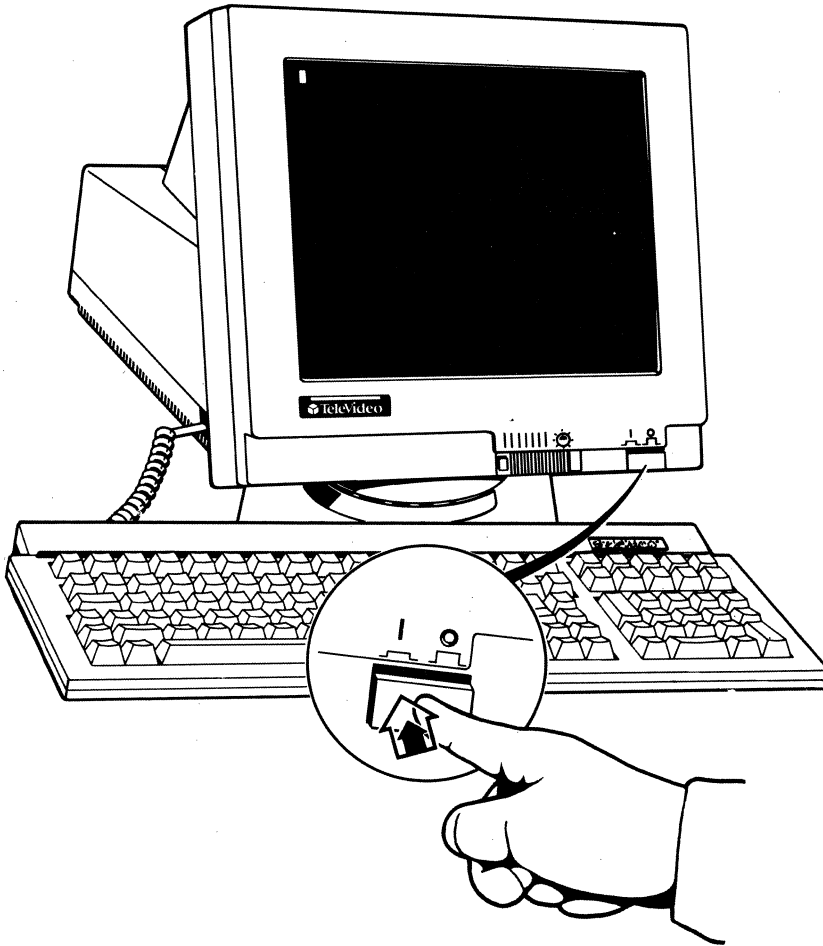

A few seconds after you turn it on, the terminal beeps. Presently the cursor appears in the upper left corner of the screen. You may also receive boot and login messages from your operating system.

The cursor can be steady or blinking, block or underline, or invisible. You can select its appearance in set-up.

The cursor position is sometimes called the active position. It is where the next character is entered or program function takes place.

Adjusting the Screen and Keyboard

You can adjust the screen and keyboard to your own preference. The figures below show how to regulate the screen contrast for your lighting conditions, tilt the case vertically and horizontally, and flip out the keyboard supports for a more comfortable typing angle.

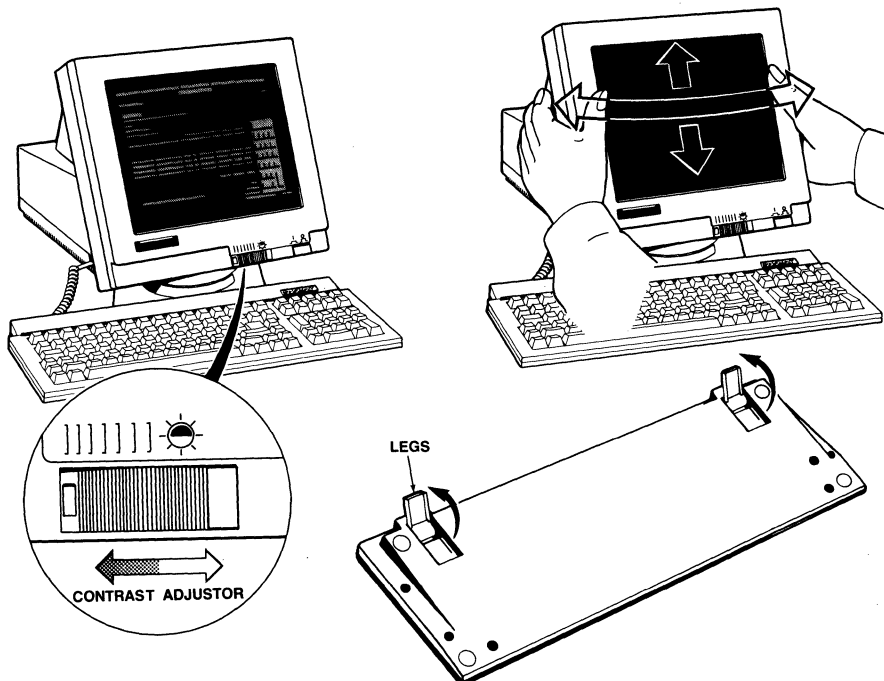

DISPLAY FEATURES

The 965 screen has three display areas:

- * A top information line
- * Data lines (24 to 49)
- * A bottom information line

This section describes the screen areas and other display features (such as the number of columns on the screen). Chapter 3 tells how to control display features in the set-up menus. Your program may also change them.

See the section titled "Local Key Functions," later in this chapter, for a summary of keys that control many display features.

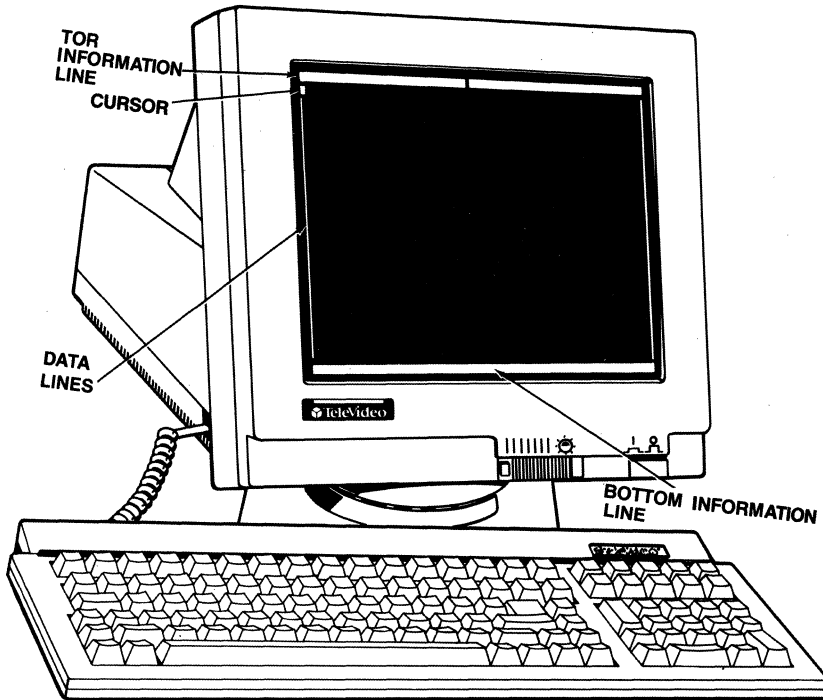

Information Lines

The top and bottom information lines may contain a variety of information:

- * The status line
- * User messages
- * Function key labels

You can choose the contents of the information lines in set-up (in the Display menu). As you read the descriptions in this section, you may find it helpful to enter set-up and look at the Display and Program menus.

Your program can also control the contents and display of the information lines, overriding your set-up choices.

NOTE: When 25, 43, or 49 data lines are displayed, the last data line always overwrites the bottom information line.

The status line The status line normally appears on the top information line. It has fields for the cursor position, a number of terminal operating states, and the time/date display.

You can toggle the status line on and off by pressing CTRL-right arrow. Your program may also turn it off or move it to the bottom information line.

The cursor position (page, row, and column) and communication mode are always displayed in the status line. Other codes appear only when the terminal enters special modes. Appendix G explains all the codes that may appear in the status line.

The time of day appears in the status line if you elect in VideoDesk to display it by selecting TIME, DATE, or DATE/TIME in the clock Display field. If your program writes a message over the time/date display, you can re-enable it in VideoDesk. See Chapter 2 for instructions.

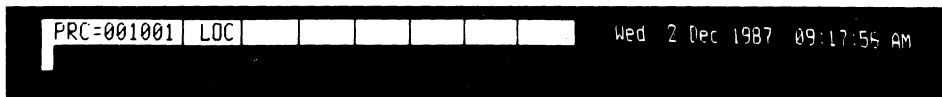

User messages Your program can display a "user message" to the operator in a full-width (80- or 132-column) message line at the top or bottom of the screen, or in place of the time and date in the status line.

You can choose in set-up where to display user messages, but you cannot write them in set-up.

NOTE: It's not at all difficult to write user messages. If you want to write your own user messages, first read "Entering Commands" in Chapter 4, then the section "Loading User Messages" in Chapter 10.

Function key labels In the Program set-up menu, you can write small labels identifying the contents of your function keys. You can then select in the Display menu to display the labels in the information lines.

Where the labels are displayed depends on your selection in set-up and on the number of columns per line:

Columns Per Line	Keys	Appear Where?
80	F1-F8	First label line (normally the bottom line)
	F9-F16	Second label line (normally the top line)
132	F1-F16	First label line (second line blank)

Pressing the SHIFT key (by itself) temporarily displays labels for the shifted function keys. Unshifted key labels return when you release the key.

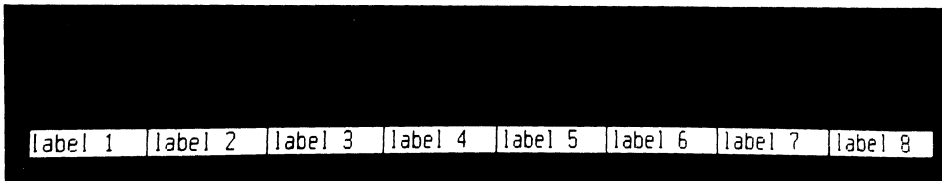

Data Lines

The 965 screen can display 24 to 49 data lines. You may select the number of lines in set-up, or your program can automatically change the number of lines.

CAUTION! Changing the number of displayed lines clears data from the screen. Save and exit files before changing the number of lines.

When you change the number of lines, your character set may also change size.

Splitting the Screen

The screen can be split into windows that show two different pages of terminal display memory. Many programs employ this split-screen feature. Pressing CTRL-PAGE lets you move the cursor between windows.

Number of Columns

You may choose between 80 and 132 columns per line on the screen. Many programs make that choice for you. The 132-column display is convenient for spreadsheets or horizontal-format documents.

Choosing 80/132-column mode in set-up lets the screen display 80 columns, but lines are actually 132 columns wide. The active position (cursor/data entry location) can be beyond the display margins. Pressing CTRL-SHIFT with the left or right arrow scrolls the display along the 132-column line, so you can find the cursor again.

NOTE: In 80/132 column mode, the cursor moves to the right edge of the *display*, no matter what column that is, then wraps to the next line. You must scroll the display so column 132 is at the right margin if you want to enter data continuously from column 1 to column 132.

Screen-Saver

The screen-saver feature makes the screen go blank after 10, 20, or 30 minutes of inactivity. Pressing CTRL-CLEAR SPACE instantly turns on screen-saver -- handy if you suddenly want to hide the display.

Blanking out the display conserves the phosphor coating inside the face of the screen. Any new data from the keyboard or host makes the display reappear.

RESETTING THE TERMINAL

The 965 does not have a dedicated reset key, but it offers several ways to reset:

Partial reset Press CTRL-SHIFT-SETUP or enter set-up and select CLEAR COMMUNICATION. This disables any currently enabled print mode, clears the main and auxiliary port buffers, and unlocks the keyboard.

Nonvolatile reset Turn the terminal off and back on again, or enter set-up and select RESET TERMINAL. This severs all communication with other system units (computer, printer, etc.), so data not saved in permanent memory may be lost, and operating parameters return to the last values saved in permanent memory.

Default reset Enter set-up and select DEFAULT PARAMETERS. This returns all operating parameters to factory-set values.

CAUTION! A default reset destroys all reprogramming, including function key messages! We do not recommend this reset.

THE KEYBOARD

This section of the manual describes the 965 keyboard and then lists the keys that let you control the terminal locally (at the keyboard).

NOTE: This section discusses Revision A 965. Revision B 965 has more keyboard features. See the Introduction section for details about Revisions A and B of the 965.

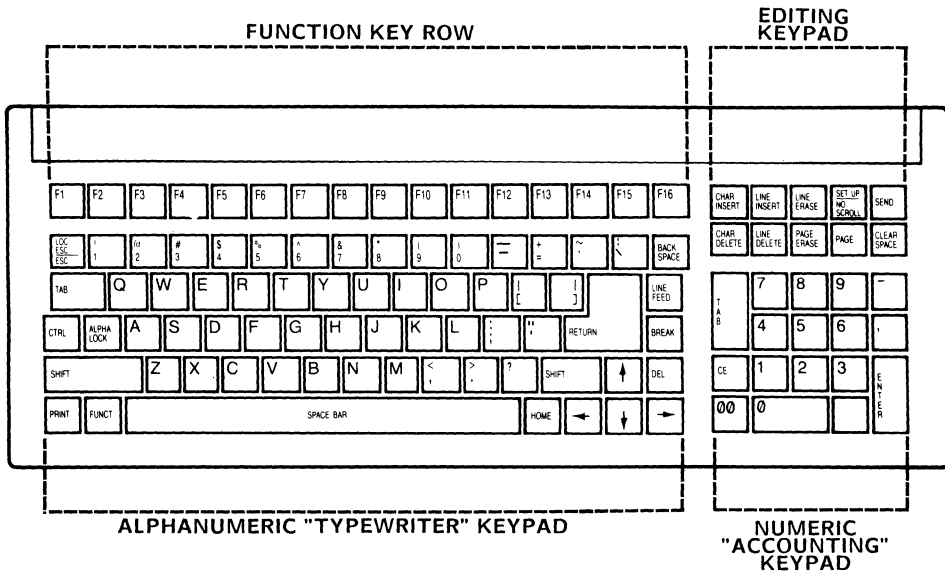

Types of Keys

Terminal manuals may classify the keys on the keyboard in several different ways:

- * **Keyboard areas, called keypads.** The illustration on the previous page names the keypads.
- * **Alphanumeric or special.** Alphanumeric keys produce a printable letter, number, or symbol, just like typewriter keys. Special keys control computer operations.
- * **Remote or local.** This distinction is most important to a terminal operator:

Remote keys Remote keys send signals (printable characters or operating messages) to the computer when the terminal is on line. When signals from the remote keys go to the computer, your program then controls their effect. For example, the BACKSPACE key may erase the character to the left of the cursor in some programs, and move the cursor in other programs. Most keys (even alphanumeric keys!) are remote keys. This means that when the computer controls the terminal, this manual cannot predict what happens when you press a remote key. You must consult your software manual.

When the terminal is not on line to the computer, it receives signals from the remote keys and responds to their commands. Appendix D lists the command codes sent by the remote keys when the terminal is off line.

Local keys Local keys always send their signals only to the terminal itself. They cause the same terminal operation regardless of the communication or terminal personality mode. So the person sitting at the keyboard can depend on these keys to control the terminal. For example, the SETUP key is a local key. When you press SHIFT-SETUP (on the ASCII keyboard), the terminal always enters set-up mode.

The following pages are a quick reference of local key operations. For more information, see the section about each function.

Local Key Operations

Key(s)	Operation
SHIFT SETUP	Enter/exit set-up mode
CTRL SHIFT SETUP	Partial reset (unlock keyboard)
CTRL BREAK	Toggle between block and current duplex communication mode
CTRL SHIFT BREAK	Toggle port configuration
CTRL SHIFT PRINT	Toggle current print mode to copy, and copy off/on
CTRL . ¹	Toggle WordStar mode on/off (see Chapter 10 and Appendix D)
CTRL SHIFT 1 ¹	Toggle monitor mode on/off
CTRL CHAR INSERT	Toggle insert mode on/off
CTRL ENTER	Toggle keyclick off/on
CTRL CLEAR SPACE	Activate screen saver
CTRL SHIFT CLEAR SPACE	Clear the screen
FUNCT F1	Enter VideoDesk clock
FUNCT F2	Enter VideoDesk calendar
FUNCT F3	Enter VideoDesk calculator
FUNCT F4	Enter VideoDesk ASCII chart

¹Numeric keypad key only.

Key(s)	Operation
CTRL 0 ¹	Display page 0 ²
CTRL 1 ¹	Display page 1
CTRL 2 ¹	Display page 2
CTRL 3 ¹	Display page 3
CTRL 4 ¹	Display page 4
CTRL 5 ¹	Display page 5
CTRL 6 ¹	Display page 6
CTRL right arrow	Toggle status line on/off
CTRL SHIFT left/right arrow	Scroll the display horizontally during 80/132-column mode
CTRL - ¹ (hyphen) CTRL , ¹	Raise/lower horizontal split
CTRL PAGE	Move to next page/window
CTRL SHIFT PAGE	Move to previous page/window
CTRL up/down arrow	Scroll display up/down
CTRL SHIFT up/down arrow	Increase/decrease scrolling rate
NO SCROLL	Toggle screen activity on/off

¹Numeric keypad key only.

²Programmers count strangely. This is page zero, rather than page one, because the page/row/column indicator in the status line starts at page zero.

PRINTER PORT CONTROLS

This section describes how to send data to the printer port. (Remember that either physical port may be the printer port. Pressing CTRL-SHIFT-BREAK toggles the printer port between the main and auxiliary ports on the back of the terminal.)

The 965 offers two methods of communicating with a serial device, such as a printer, connected to the printer port:

- * Enabling a printer port mode, which **passes data through the terminal** between the computer or keyboard and a device (e.g., a printer) connected to the printer port. Depending on the print mode, the data may or may not appear on the terminal screen.
- * Executing a page print, which **sends on-screen data** to the printer (much like the Prt Sc key function of a personal computer)

Unlike the host port communication modes (explained later in this chapter), the 965 comes from the factory with all printer port modes disabled. You (or your program) must enable a printer port mode to pass data between the host and the printer port.

If you have a problem with printing, see the troubleshooting suggestions at the end of the chapter.

Printer Port Modes

Four printer port modes can be enabled by your program or in set-up. Pressing CTRL-SHIFT-PRINT has two effects on print modes: It first changes the current print mode to copy mode, and then toggles copy mode on and off.

Copy Sometimes called "typewriter" or "type-thru" mode. Characters from the keyboard or host are simultaneously displayed on the screen and sent to the printer.

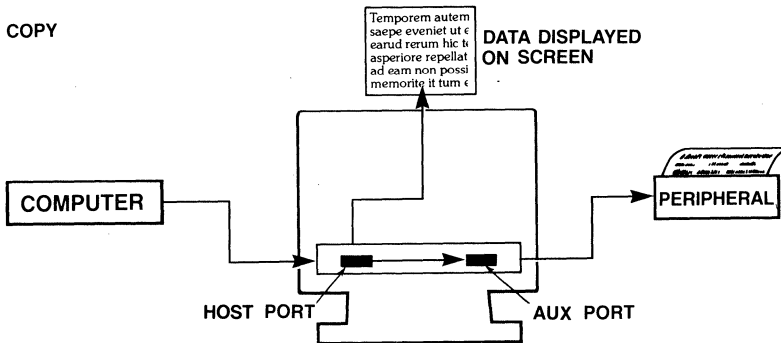

Transparent Characters from the host or keyboard are sent to the printer without affecting the screen display. The display freezes during transmission.

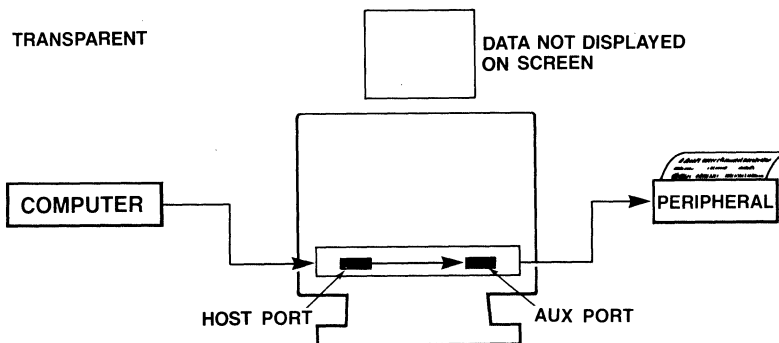

Bidirectional Data from the host or keyboard goes to both the screen and peripheral, just like copy mode. In addition, the device (printer or other peripheral) connected to the printer port can send data through the terminal to the computer. When data flows from the peripheral to the computer, it is not displayed on the screen.

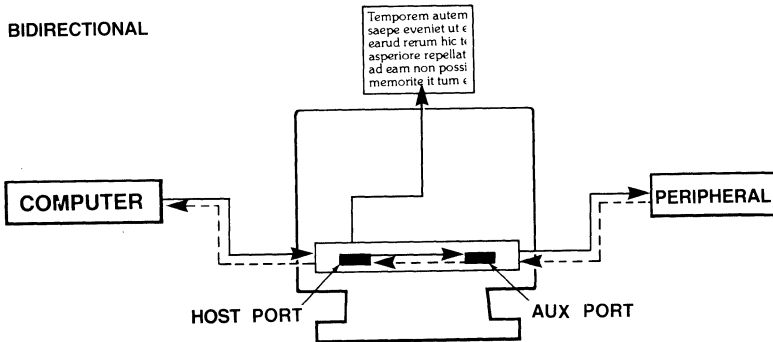

Secondary receive The terminal passes data to the host from the device connected to the printer port; data from the host or keyboard goes only to the screen.

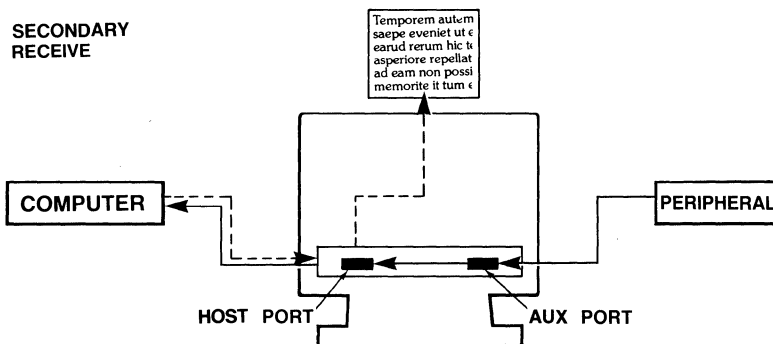

A Page Print

A *page print* sends data on the current page (up to the cursor position) to the printer port. The terminal flips the next page of display memory onto the screen, unless page print flip mode has been disabled.

For a *formatted* page print, press PRINT. Each line sent to the printer ends with a carriage return and line feed, so the printed copy resembles the screen, as shown below.

For an *unformatted* page print, press SHIFT-PRINT. Without formatting, the appearance of the printed output varies, depending on the amount of space characters the data contains.

a. Screen Data

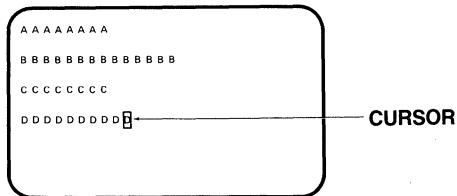

b. Formatted Page Print

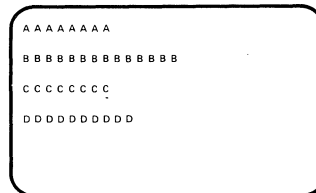

c. Unformatted Page Print (Sample)

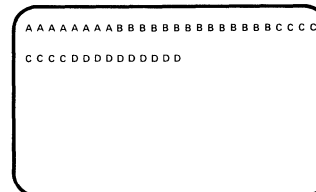

Pressing CTRL-SHIFT-SETUP interrupts transmission from the terminal to the printer.

HOST PORT COMMUNICATION

This section describes the host port communication modes and related terminal operations.

The 965 communicates with the computer (sends and receives data) through the host port. Remember that either physical port may be the host port. Pressing CTRL-SHIFT-BREAK toggles the host port between the main and auxiliary ports on the back of the terminal.

Host Port Communication Modes

The host port communication mode determines where data goes when you press a key -- to the screen, the computer, or both. Following is a brief explanation of each communication mode.

Full duplex Most "interactive" application programs (those where you enter commands or data and the computer responds) work best with the 965 in full duplex communication mode. Your 965 is set for full duplex mode when it comes from the factory.

In full duplex mode, the terminal sends key codes only to the computer and not to the terminal. However, computers often "echo" key codes back to the terminal, so the printable characters you type appear on your screen.

Half duplex If your computer does not echo key codes back to the terminal, you can set it for half duplex. Then the terminal sends key codes both to the computer and to the screen.

NOTE: You can switch between the currently enabled conversational mode (full or half duplex) and block mode by pressing CTRL-BREAK.

Block Data you enter goes only to the screen until you send it to the computer by pressing the SEND key. However, the terminal can still receive any data the computer sends.

Local The terminal turns off all communication with the computer. Data entered at the keyboard goes to the screen, and the terminal does not receive any data from the computer. All keys act as local keys.

NOTE: Once the terminal is in local mode, it cannot receive any commands from the computer to change to another communication mode! To restore communication, you (the operator) must reset the terminal or enter set-up and change the mode.

See the troubleshooting suggestions at the end of this chapter if double characters or no characters at all appear when you enter data.

A Block Send

The SEND key sends screen data to the computer when the terminal is in block mode.

For a *page send*, press SEND. All data from the top of the screen through the cursor position goes to the computer.

For a *line send*, press SHIFT-SEND. Data on the cursor line through the cursor goes to the computer.

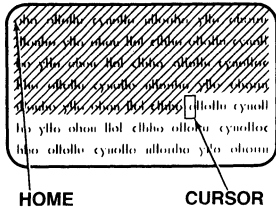

PAGE SEND

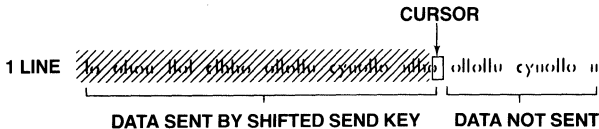

LINE SEND

Pressing CTRL-SHIFT-SETUP interrupts transmission from the terminal to the computer.

Editing Key Modes

Editing key modes affect most editing keys (keys that control cursor movement, editing, and data transmission). Your application program usually determines the editing key mode, but you can also change it in set-up (in the Program menu).

NOTE: If your editing keys do not operate as expected, check the communication and editing key modes.

The 965 has three editing key modes:

Local Editing key commands go *only* to the screen, in all communication modes. In effect, the editing keys become local keys. So you can always use the editing keys to move the cursor, change data on the screen, and send data to the computer and printer.

Host Editing key commands go only to the computer, in all communication modes except local. How the computer handles them depends entirely on its programming.

Normal Editing key commands are handled the same as other characters you type -- they go to the computer and/or the screen, depending on the communication mode.

Monitor Mode

A terminal usually displays printable (alphanumeric) characters such as letters, numbers, and punctuation symbols on the screen. But it also receives many other characters (called *codes*) that are commands. They do not appear on the screen; instead, the terminal interprets and responds to them. (For example, when the terminal receives the command **CTRL Z**, it clears the screen.)

When monitor mode is enabled, the terminal no longer responds to commands from the computer or keyboard. It displays all data (printable characters and command codes) on the screen. The figure on the next page shows an example of command and printable characters on the screen in monitor mode.

Programmers use monitor mode to display the contents of a program on the screen, or to find out what code an editing key sends.

To toggle monitor mode on and off, press SHIFT-CTRL-1 (numeric keypad one).

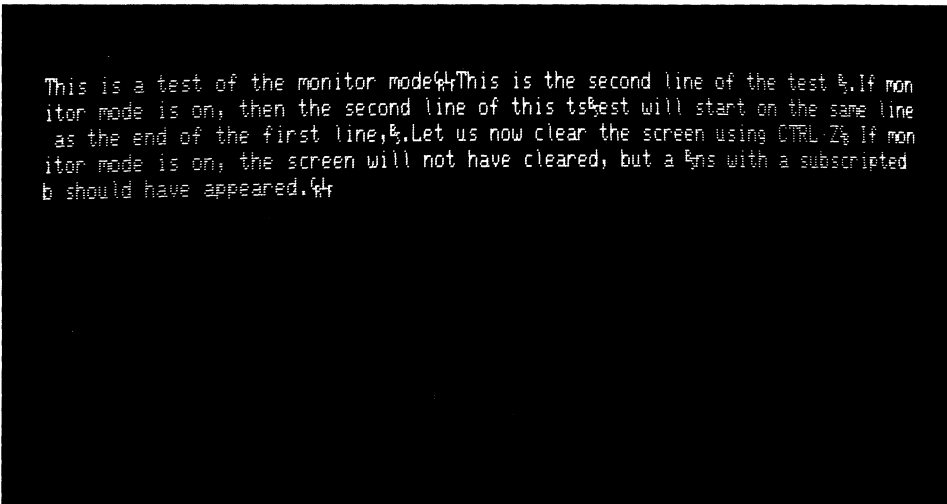

```
This is a test of the monitor mode. This is the second line of the test. If monitor mode is on, then the second line of this test will start on the same line as the end of the first line. Let us now clear the screen using CTRL-Z. If monitor mode is on, the screen will not have cleared, but a b with a subscripted b should have appeared.
```

IF A PROBLEM OCCURS

Your 965 terminal should give you years of trouble-free service, once you have properly installed it and checked that its operating values match those of your computer and printer. However, if it does not operate properly, follow the suggestions in the troubleshooting list below before placing a service call to your dealer or distributor.

Troubleshooting Checklist

If the terminal doesn't operate at all:

- * Are all cables firmly plugged in at both ends? (You'd be surprised how often this is the problem!)
- * Are all system units turned on?
- * Is your terminal locked up? Turn it off and back on.
- * Do you need to replace the line fuse? See the instructions in the next section.

If the terminal doesn't communicate with the host or modem:

- * Are you in the proper operating mode? The correct communication mode? Check the status line.
- * Is your computer operating system booted up?
- * Do the terminal and computer communication formats match? Check the set-up menu of the port selected as the host port for the terminal communication format.
- * Is the interface between the terminal and the computer or modem correctly wired? Check the computer port pin signals (see Chapter 11). Ensure that pins 1, 2, 3, 7, and 20 are connected as specified.
- * Is your modem operating correctly? Check its instructions; if necessary, contact the manufacturer for assistance.

If the terminal doesn't communicate with the printer or other peripheral:

- * Is the interface cable firmly plugged in at both ends?
- * Is your application program correctly configured for your peripheral?
- * Are the communication, editing key, PRINT key operation and print modes set so the terminal receives the PRINT key codes and printing commands?
- * Does the printer port communication format match that of your serial peripheral?
- * Is the interface between the terminal and the peripheral correctly wired? Check the printer port pin signals (see Chapter 11).

If the screen display is faint or wavering, or the cursor does not appear correctly:

- * Have you adjusted the screen brightness?
- * What cursor style is specified in set-up?
- * Is the hertz setting correct for your power system?

If nothing happens when you type on the keyboard:

- * Is the keyboard correctly plugged in?

CAUTION! Do not plug or unplug the keyboard cable while the terminal is turned on. A power surge may result, which could severely damage the terminal.

- * Is the keyboard locked? Press CTRL-SHIFT-SETUP or reset the terminal.
- * Does your communication mode send keystrokes to the screen? Try block or local communication mode.

Running the Self Test

You can verify proper operation of the terminal video display circuitry by running the self test. The test shows all displayable characters and visual attributes.

NOTE: Running the self test crases any data on the screen.

1. Press **SETUP (SHIFT-NO SCROLL)**. The Command set-up menu appears.
2. Press **1**. The test screen appears:

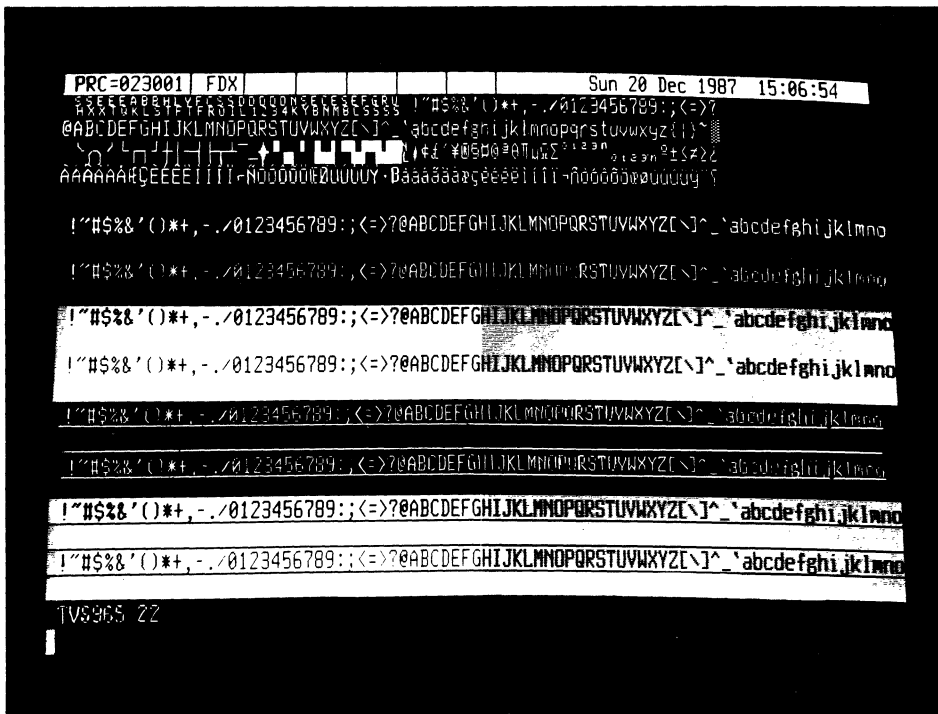

3. Check the screen:
 - * Four lines should blink.
 - * All 256 characters (ASCII control and display; graphics) should be displayed.
 - * Each character should be formed properly, with no extra or missing dots.
 - * The screen should show all the visual attributes in both full and half intensity.
 - * The firmware revision level should appear in the lower left corner.
4. Press CTRL-SHIFT-CLEAR SPACE to clear the test from the screen.

If You Need Assistance

Your TeleVideo dealer can help you solve problems and obtain service. Before calling your dealer, review the troubleshooting checklist in this chapter and check the operating parameters (turn to Chapter 3 to review them). Try to place the terminal by the phone. Have the terminal serial number, found on the rear of the case, and this manual at hand.

The terminal is covered by a limited warranty, which should be packed with the terminal (see your dealer if by chance it was omitted from your package). No warranty registration is required.

If you need service during the warranty period, call your dealer. You can obtain on-site or carry-in service from authorized third-party service agencies.

Should you need to ship the terminal to TeleVideo for repair, ask your dealer to first contact TeleVideo and secure a Return Material Authorization (RMA) number. TeleVideo does not accept items for repair without an RMA number. Then carefully repack the terminal, using either the original TeleVideo shipping container or other suitable materials. Keep this manual; don't return it with the unit.

2 VIDEODESK

General Information	2.2
Entering and Leaving VideoDesk	2.2
Moving From One Window to Another	2.3
Moving the Window Around the Screen	2.4
The Clock	2.5
Setting the Clock/Calendar	2.6
Displaying the Date and Time	2.7
Setting the Alarm Clock and Bell	2.8
The Notepad	2.9
The Calendar	2.10
The Calculator	2.11
Key Functions	2.12
Examples	2.13
The ASCII Chart	2.15

2 VIDEODESK

The 965's VideoDesk program consists of four pop-up accessories:

- * A clock that can display the time and date in the status line as you work in a program. It also has an alarm function.
- * A calendar for the years 1901 to 2099.
- * A calculator that can transfer calculations from VideoDesk to the display and can give you a "tape" print-out of your calculations.
- * An ASCII chart that shows decimal, octal, hexadecimal, and binary values for the currently loaded character set.

The accessories appear in windows that overlay your current text display, but do not destroy any on-screen data. You can also move the windows around so you can see any desired portion of the screen.

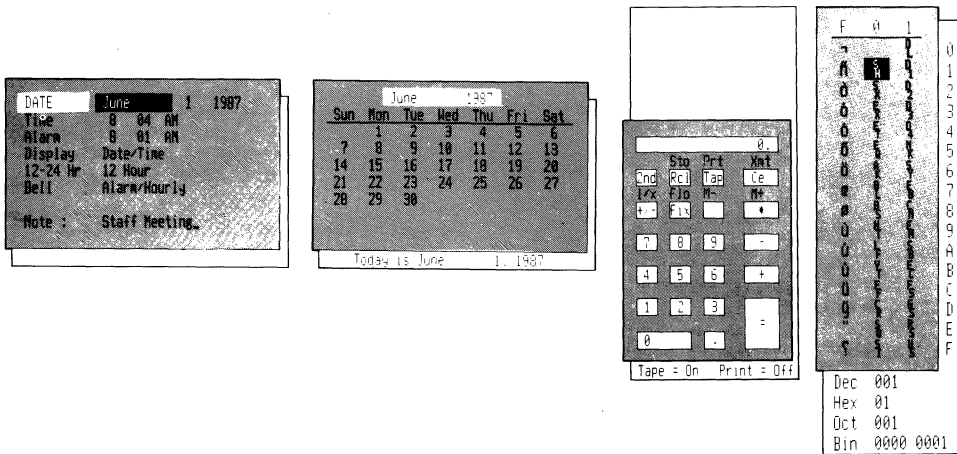

GENERAL INFORMATION

This section presents the operating details common to all four VideoDesk accessories. Following are separate sections that describe in detail the operation of each accessory.

Entering and Leaving VideoDesk

To enter an accessory, press FUNCT plus a function key:

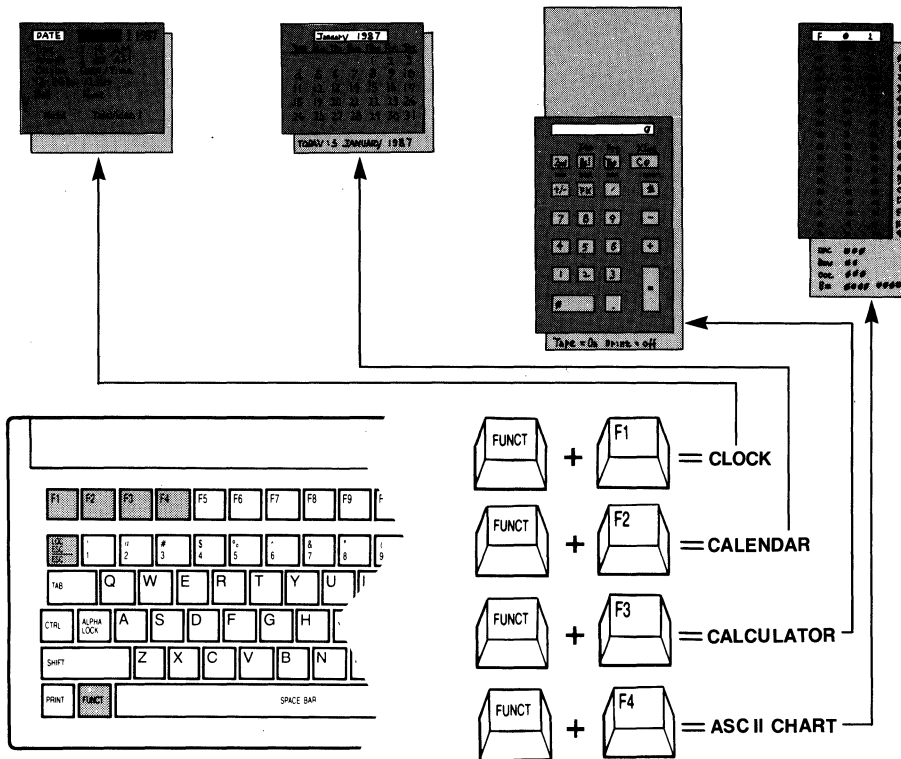

To leave VideoDesk, press ESC.

Moving From One Window to Another

Once you are in VideoDesk, you can move from any one window to any other by pressing the appropriate function key by itself:

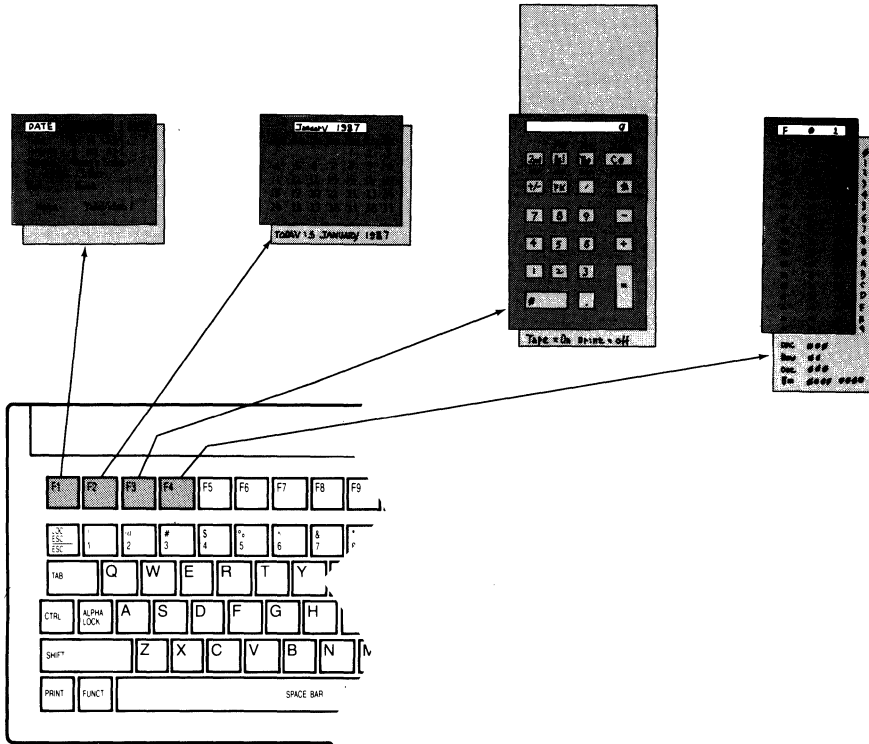

NOTE: In the section explaining each VideoDesk accessory, the function keys that move you to the other accessories are illustrated in the page margin. For example, in the section that tells about the calendar, you'll see this:

<-- F1 Clock

F3 Calculator -->
F4 ASCII Chart -->

This reminds you that you can move between accessories by simply pressing a function key. It also reminds you in which direction in this text you can find information about the other accessories.

Moving the Window Around the Screen

You can move a VideoDesk window left, right, up, or down on the screen by pressing an arrow key together with the SHIFT key:

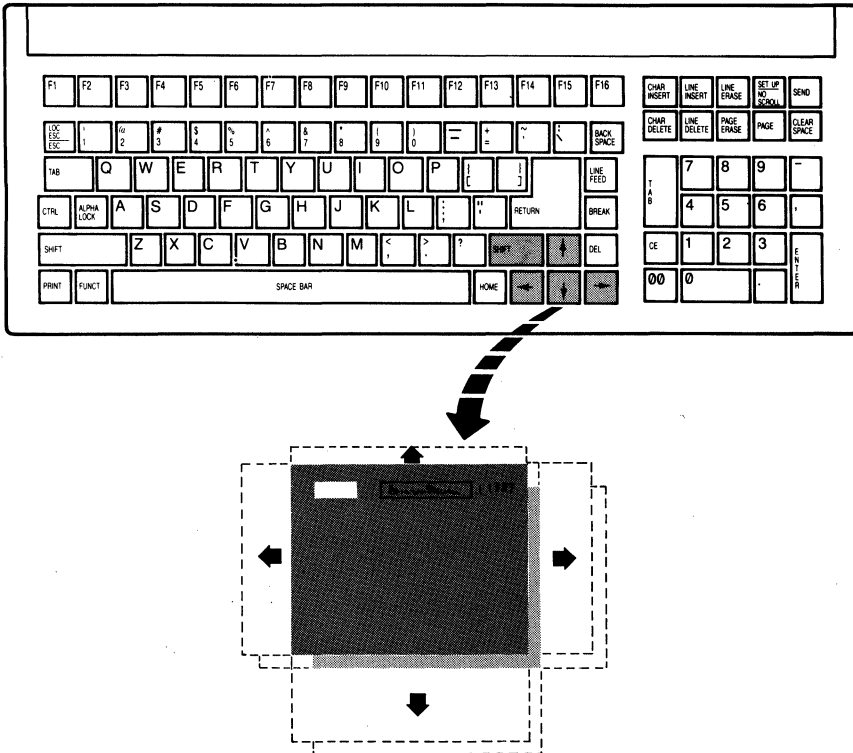

THE CLOCK

The first thing to do in VideoDesk is set the time and date. Press FUNCT-F1 to pop the clock window up on your screen.

The right and left arrow keys move the highlight bar from field to field. The up and down arrows toggle through the values in the highlighted field.

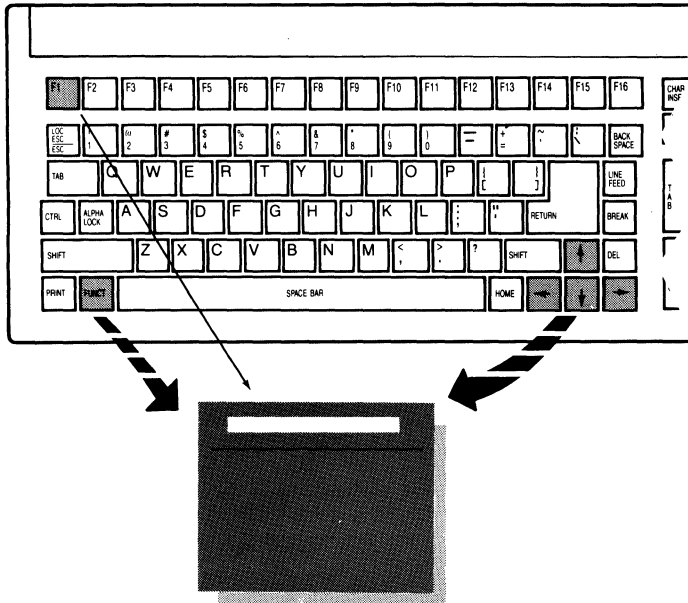

F2 Calendar -->
F3 Calculator -->
F4 ASCII Chart -->

Setting the Clock/Calendar

When the clock appears, the highlight bar is in the month area of the Date field. Press the up or down arrow until the correct month appears.

Now press the --> key to move to the day and year areas. In each area, set the correct values with the up and down arrows. Do the same in the hour, minute, and am/pm areas of the Time field.

NOTE: If you reset the 965, it remembers the VideoDesk time, date, and other values. But the clock does not run while the terminal is turned off. For example, if you turn the terminal off at 5 p.m. and back on at 8 a.m. the next morning, the clock/calendar continues to keep time from 5 p.m. of the previous day!

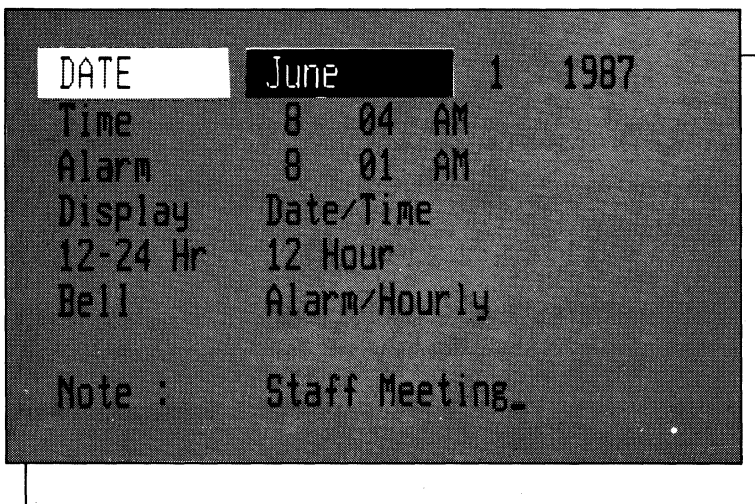

F2 Calendar -->
F3 Calculator -->
F4 ASCII Chart -->

Displaying the Date and Time

The 965 can display the date and time in the status line. You select the date/time display in two areas:

- * Select NONE, TIME, DATE, or DATE/TIME in the VideoDesk clock Display field.
- * Select the status line display values in the TOP LINE and BOTTOM LINE parameters in the Display set-up menu.

12- or 24-hour mode lets you select either a 12-hour clock that displays a.m./p.m. with the time, or a 24-hour (military) clock. (When you select 24-hour mode, the terminal automatically converts the 12-hour time from the VideoDesk Time field to 24-hour time in the status line display.)

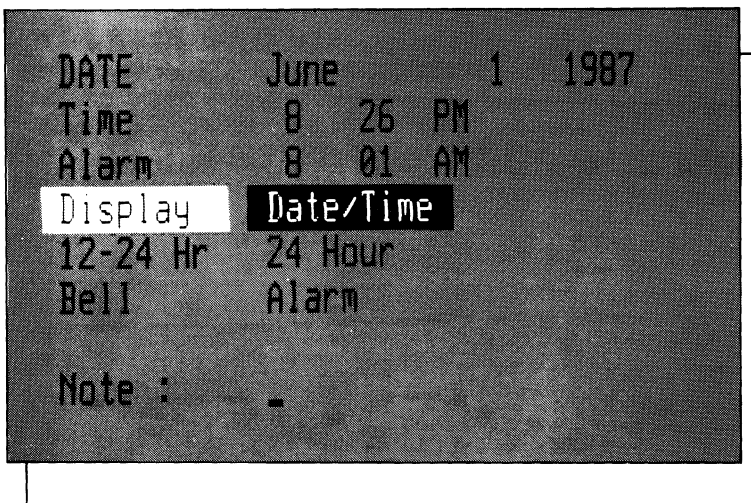

F2 Calendar -->
F3 Calculator -->
F4 ASCII Chart -->

Setting the Alarm Clock and Bell

To set and turn on the alarm, first set the alarm time as you would the clock time. Then set the Bell field to either Alarm or Alarm/Hourly.

To disable the alarm, set the Bell field for either None or Hourly.

When the alarm goes off, the bell sounds and the clock pops up on your screen. Press ESC to remove it.

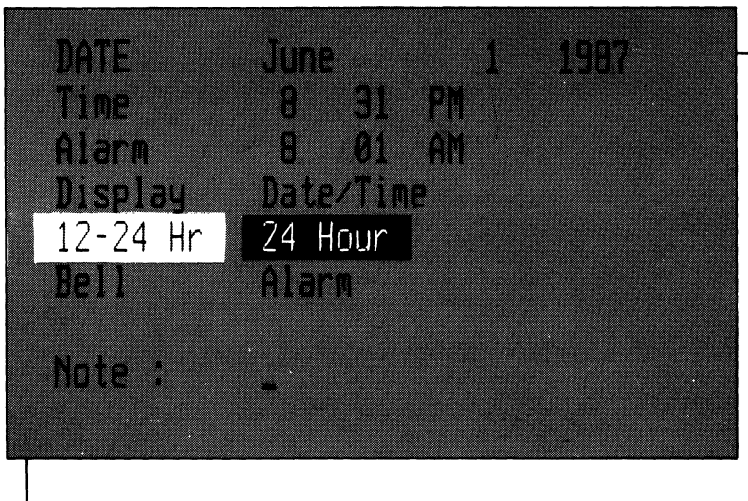

F2 Calendar -->
F3 Calculator -->
F4 ASCII Chart -->

The Notepad

At the bottom of the clock is a 20-character notepad, handy for inserting a reminder when you set the alarm. To write a message, first move the highlight bar to the Note field. Press the BACK SPACE key to erase the current message, and start typing.

NOTE: Move the cursor with the space bar and BACK SPACE key, not the cursor keys.

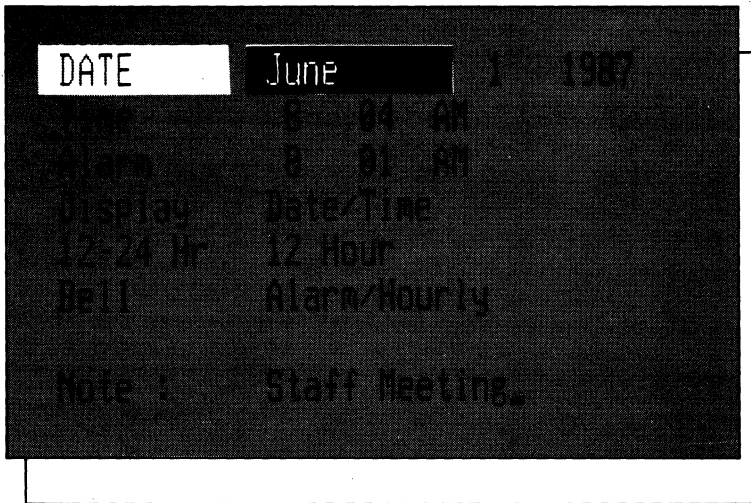

F2 Calendar -->
F3 Calculator -->
F4 ASCII Chart -->

THE CALENDAR

Press FUNCT-F2 to pop the calendar window up on your screen.

The calendar automatically displays the month you set in the Date field of the clock. To display other months of the current year, press the right and left arrows; to display other years, press the up and down arrows.

You need not return the calendar to the current date; it resets automatically when you return to the clock (F1) or reset the terminal.

June 1987						
Sun	Mon	Tue	Wed	Thu	Fri	Sat
	1	2	3	4	5	6
7	8	9	10	11	12	13
14	15	16	17	18	19	20
21	22	23	24	25	26	27
28	29	30				

Today is June 1, 1987

<-- F1 Clock

F3 Calculator -->
F4 ASCII Chart -->

THE CALCULATOR

Press FUNCT-F3 to display the calculator.

The calculator uses the accounting-style numeric keypad and the editing keys above it, at the far right of your keyboard. Disregard the legends on the actual keyboard, and keep your eyes on the on-screen calculator pad as you calculate. The active key (the key last pressed) is displayed in reverse video.

The full-intensity area above the calculator pad on screen is the "tape" area. Every calculator entry can be output to the tape or to your printer (or both). The line at the bottom of the calculator indicates whether the tape and printer output are on or off.

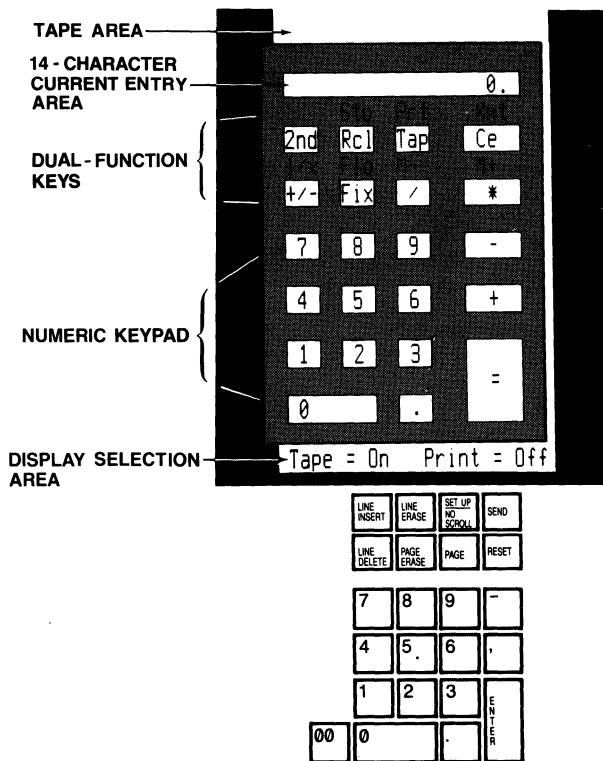

<-- F1 Clock
<-- F2 Calendar

F4 ASCII Chart -->

Key Functions

Here's a summary of what the (on-screen) calculator keys do:

Key	Function
0-9	Numbers, displayed in current entry area.
	Decimal point.
+, -, *, /, =	Operands (add, subtract, multiply, divide, equals).
M+	Adds current entry to the number in memory.
M-	Subtracts current entry from the number in memory.
Fix	Enables fixed decimal point, zero to four places, depending on number of times pressed (default two).
Flo	Enables floating decimal point.
+/-	Toggles the sign of the current entry.
1/x	Computes the inverse of the current entry.
Ce	Clears the current entry; clears the operation and starts a new calculation when pressed twice.
Xmt	Transmits the current entry to the active position in your program; also exits VideoDesk.
Tap	Toggles tape display on/off.
Prt	Toggles printer output on/off.
Rcl	Recalls the number stored in memory.
Sto	Stores the current entry in memory.
2nd	Selects the second function of a key (displayed above the calculator key). Press and release this key, then press the desired key to invoke its second function.

<-- F1 Clock
<-- F2 Calendar

F4 ASCII Chart -->

Examples

The best way to learn how to use the calculator is just to start in using it. Display the calculator (press FUNCT-F3), position your right hand over the keyboard numeric keypad (keep your eyes on the screen), and begin:

Simple arithmetic; clearing an error Enter $64+128=$. In reality, you will press , for + and ENTER for =. If you make a mistake, press Ce to clear the current entry line, and start the current entry again. Each time you press an operand, the current entry goes to the tape.

Selecting the second function; storing a number in memory The result of the above calculation is 192 ($64 + 128 = 192$). It should be displayed in the current entry line. Press 2nd, then press Rcl. This invokes the Sto key and stores 192 in memory.

More simple arithmetic Now enter $16*32=$. This multiplies 16 times 32. The result, 512, appears in the current entry line.

Adding to the number in memory Press 2nd, then press *. This invokes the M+ key, adding the current entry, 512, to the number in memory (192). The result, 704, appears as the current entry.

Toggling the sign Press +/- . The number in the current entry line, 704, changes to -704.

Transferring a number to the screen Press 2nd, then Ce. This transfers the current entry (-704) to the cursor position in your program and leaves VideoDesk.

<-- F1 Clock
<-- F2 Calendar

F4 ASCII Chart -->

Now enter the calculator again (press FUNCT-F3) and start another set of examples:

Turning the printer output on Press 2nd; then press Tap. This toggles the printer display on. The display selection area at the bottom of the calculator changes from **Tape = On Print = Off** to **Tape = On Print = On**. Now you will both see your calculations in the tape area and have a record of them from your printer.

Changing to fixed decimal point format Before starting any calculations, press Fix to change the decimal point format from floating to fixed. Continue to press Fix until the desired number of decimal places (zero to four) appears. (In this case, choose two places.) Note that the fixed decimal format always returns to the *number of places previously set*.

NOTE: Fixed decimal format *truncates* an amount, rather than rounding it off. This means that 2.229, for example, displays as 2.22, rather than 2.23.

Simple arithmetic Enter 347-18=. The answer, 329, appears in the current entry area. Press /6= to divide this figure by six. The result, 54.8333, is truncated at two decimal places.

Storing a number in memory Press 2nd, then press Rcl. This invokes the Sto key and stores 54.8333 in memory.

Finding the inverse Enter .47. Press 2nd, then +/- to invoke the 1/x key and find the inverse amount. The answer, 2.1276, is truncated to 2.12.

Subtracting the number in memory Press 2nd, then /. This invokes the M- key and subtracts the current entry, 2.1276, from the number you previously stored in memory, 54.8333. The result, truncated to 52.70, appears in the current entry area and is also stored in memory.

Recalling a number from memory Now press 695.99/Rcl. In turn, this displays and sends to the printer 695.99/, then 52.70, then the result (13.20).

<-- F1 Clock
<-- F2 Calendar

F4 ASCII Chart -->

THE ASCII CHART

Shown below is the default ASCII chart that appears when you press FUNCT-F4.

The ASCII chart can display up to 256 characters and give the decimal, hexadecimal, octal, and binary values of the active position shown in reverse video. But the characters that appear in the chart depend entirely on which character set is loaded in the terminal's character generator.

Press the four arrow keys to move the active position around in the chart.

F	0	1
0	1	2
3	4	5
6	7	8
9	A	B
C	D	E
F		
Dec	001	
Hex	01	
Oct	001	
Bin	0000	0001

- <-- F1 Clock
- <-- F2 Calendar
- <-- F3 Calculator

3 SET-UP

Review of the Set-Up Process	3.3
Enter Set-Up	3.3
Select a Set-Up Menu	3.4
Select a Set-Up Field	3.5
Change the Parameter Value	3.6
Save Set-Up Values	3.7
Leave Set-Up	3.8
Parameter Menus	3.9
The Command Menu	3.9
The General Menu	3.11
The Display Menu	3.14
The Keyboard Menu	3.17
The Main Menu	3.19
The AUX Menu	3.21
The Attribute Menu	3.23
The Program Menus	3.25
The Function Key Submenu	3.25
The Editing Key Submenu	3.29
The Keypad Submenu	3.31
The Answerback Submenu	3.33
The Delimiter Submenu	3.35

3 SET-UP

This chapter tells how to check operating characteristics (parameters) and, if desired, change them in set-up mode.

The 965 is ready to operate the first time you turn it on. But you need to check that its parameters agree with your computer, your printer and other peripherals, and your application programs.

In general, there are three types of set-up parameters:

- * Communication values that must match those of other system components. (For example, the terminal and computer must communicate at the same baud rate.)
- * Operating values that must agree with your application program. (Does your spread sheet require 80 or 132 characters per line? What terminal emulation mode does your program require?)
- * Personal preference values. (Do you prefer silent or clicking keys? Dark or light screen background?)

When in doubt about a particular parameter, don't change it. The default (factory set) values are those commonly employed in system communication and data entry/processing.

Application programs often reset terminal parameters for you automatically. Refer to your computer and application program manuals first, or consult your system manager, for specific information about your system.

CAUTION! Before changing the terminal personality or display configuration (number lines, columns, or pages of memory), save any data on the screen before entering set-up. Changing these parameters clears the screen.

These are the set-up menu titles and the parameters each menu controls:

Title	Parameters
Command	Exit; save parameters; reset values; clear screen and communications.
General	Port configuration; terminal modes: personality, communication, monitor, line wrap, edit, font load, send acknowledge, received carriage return.
Display	Number of lines and columns per page, page length, status line attribute, top and bottom line content, cursor attributes, screen background and saver, scrolling speed.
Keyboard	Keyclick, key repeat, key lock; margin bell, RETURN, ENTER, and BREAK key functions, national character sets, WordStar mode.
Main	Main port communication values.
Aux	Auxiliary port communication values.
Attribute	Visual attribute characteristics, write-protect attributes.
Program	Function, editing, and numeric keypad key codes; plus answerback message and block send delimiters.

To enter set-up mode, press SETUP (SHIFT and NO SCROLL together). Then use the cursor keys to move through a series of eight screen menus and the space bar to toggle values.

The first seven menus present parameters from which you can choose a value or toggle an action. The Program menu branches to a group of submenus where you can reprogram keys and messages.



For a detailed example of changing values in set-up, read over the next section, "Review of the Set-Up Process."

REVIEW OF THE SET-UP PROCESS

The following example shows how to change the screen background from dark to light. This process applies to changing any number of parameters.

1. Enter Set-Up

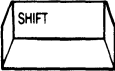
Press SETUP (SHIFT and NO SCROLL together). The terminal finishes any send or print operations in progress and signals the computer that it cannot accept any data during set-up. Then the set-up Command menu appears on the screen.

PRESS  +  TO DISPLAY THE COMMAND MENU

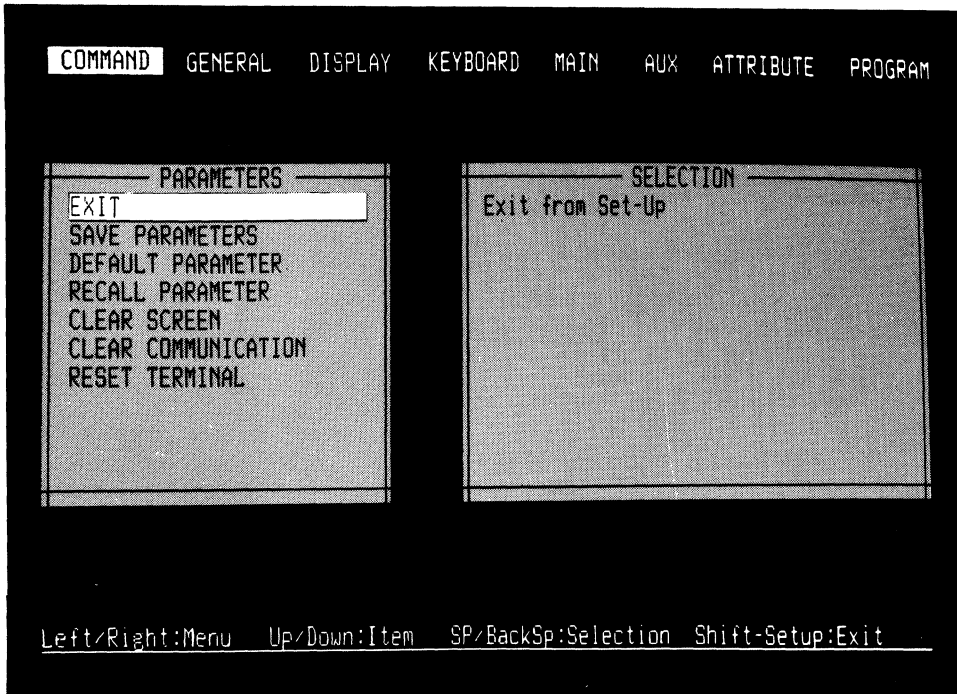

2. Select a Set-Up Menu

Names of the set-up menus appear at the top of the screen. You can enter each menu by using the following procedure:

Press the left and right arrow keys to move the highlight cursor to the name of the desired menu. As you move from name to name, the items under each menu appear.



PRESS TO MOVE TO THE DISPLAY MENU

COMMAND	GENERAL	DISPLAY	KEYBOARD	MAIN	AUX	ATTRIBUTE	PROGRAM
---------	---------	----------------	----------	------	-----	-----------	---------

PARAMETERS	SELECTION
COLUMNS = 80	80 80/132 80 ECONOMY
LINES = 24	132
PAGE LENGTH = 1 x LINES	
STATUS LINE = REVERSE	
TOP LINE = STATUS	
BOTTOM LINE = NONE	
CURSOR TYPE = BLK STEADY	
BACKGROUND = DARK	
SCREEN SAVER = 10	
SCROLL SPEED = JUMP	

Left/Right:Menu Up/Down:Item SP/BackSp:Selection Shift-Setup:Exit

3. Select a Set-Up Field

Press the up and down arrows to move the highlight cursor among fields in the left window. The specific values for each field appear in the window on the right side of the screen.



PRESS TO MOVE TO THE BACKGROUND FIELD

```
COMMAND  GENERAL  DISPLAY  KEYBOARD  MAIN  AUX  ATTRIBUTE  PROGRAM

PARAMETERS
COLUMNS = 80
LINES = 24
PAGE LENGTH = 1 x LINES
STATUS LINE = REVERSE
TOP LINE = STATUS
BOTTOM LINE = NONE
CURSOR TYPE = BLK STEADY
BACKGROUND = DARK
SCREEN SAVER = 10
SCROLL SPEED = JUMP

SELECTION
DARK

Left/Right:Menu  Up/Down:Item  SP/BackSp:Selection  Shift-Setup:Exit
```

4. Change the Parameter Value

Press the space bar or BACK SPACE key until the desired value is highlighted. The highlighted value is now the "new value" and may be saved permanently in nonvolatile memory, or temporarily until you reset or turn off the terminal.

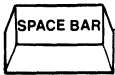

PRESS TO CHANGE THE VALUE

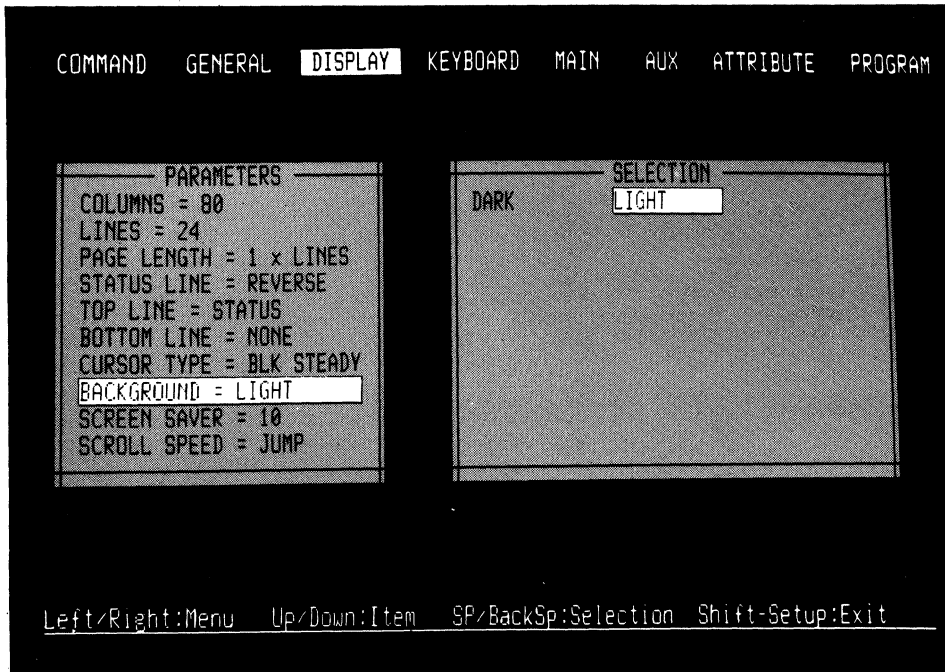

COMMAND GENERAL **DISPLAY** KEYBOARD MAIN AUX ATTRIBUTE PROGRAM

PARAMETERS	SELECTION
COLUMNS = 80	DARK
LINES = 24	LIGHT
PAGE LENGTH = 1 x LINES	
STATUS LINE = REVERSE	
TOP LINE = STATUS	
BOTTOM LINE = NONE	
CURSOR TYPE = BLK STEADY	
BACKGROUND = LIGHT	
SCREEN SAVER = 10	
SCROLL SPEED = JUMP	

Left/Right:Menu Up/Down:Item SP/BackSp:Selection Shift-Setup:Exit

5. Save Set-Up Values

Return to the Command menu. Move the highlight cursor to the field SAVE PARAMETERS and press the space bar.

If you don't save your parameters, the values you changed remain in effect only until you turn off the power (or reset the terminal). Values then return to the last values saved in permanent (nonvolatile) memory.



PRESS TO RETURN TO THE COMMAND MENU

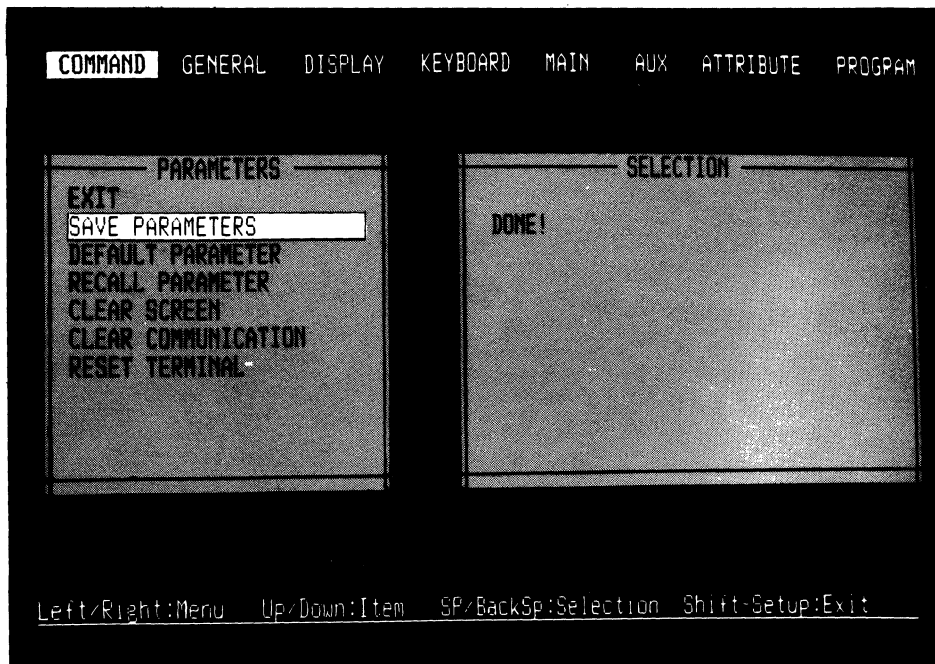



6. Leave Set-Up

You can leave set-up by two methods:

- * Move the highlight cursor to the EXIT field in the Command Menu and press the space bar
- * Press SETUP (SHIFT-NO SCROLL) from any menu

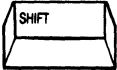
Remember, leaving set-up does not automatically save your new values. You must save them by the method explained in Step 5.

PRESS  +  TO LEAVE SET UP
OR

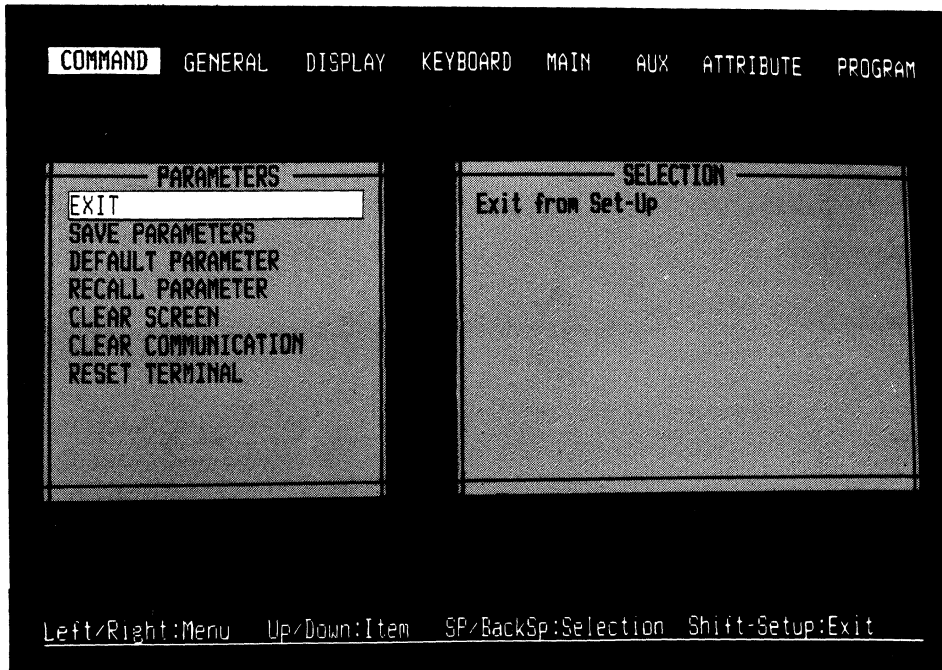

PARAMETER MENUS

This section presents the first seven set-up menus.

The Command Menu

All the fields in the Command menu indicate a terminal action. Table 3-1 briefly explains the effect of each action and refers to the section of the manual that contains a detailed explanation.

NOTE: The last field in the Command menu, DEFAULT KEY CODES, is not pictured here.

Command Menu

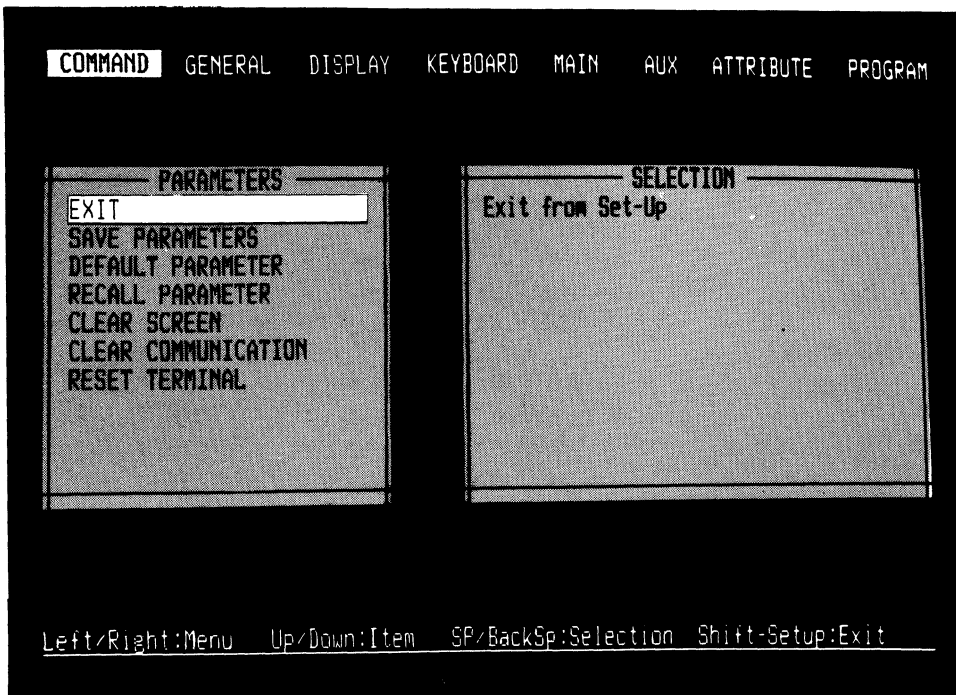

Command Menu Parameters
Table 3-1

Field	Action
EXIT	Leaves set-up and returns to the previous screen display and operating modes. Does not save set-up values.
SAVE PARAMETERS	Saves <i>current</i> set-up values in permanent memory. (Chapter 4)
DEFAULT PARAMETERS	Resets all parameters to factory default values. (Chapter 4) STOP! This action destroys all reprogrammed operating values!
RECALL PARAMETERS	Returns <i>current set-up values</i> to those last saved in nonvolatile (permanent) memory. If you accidentally mess up set-up values, this action recalls the last <i>saved</i> values.
CLEAR SCREEN	Clears screen display.
CLEAR COMMUNICATION	Unlocks the keyboard; clears the host and auxiliary port buffers; disables any print mode enabled. (Chapter 5)
RESET TERMINAL	Returns <i>all operating values</i> to those last saved in nonvolatile memory; leaves set-up. (Chapter 4)
DEFAULT KEY CODES	Returns editing and function keys to default codes of the <i>current</i> personality. STOP! This action destroys all reprogramming in the function and editing keys!

The General Menu

The General menu controls a number of terminal operating modes. Table 3-2 gives a brief summary of each parameter and refers to the section of the manual that contains a detailed explanation.

General Menu, Default Values

```
COMMAND  GENERAL  DISPLAY  KEYBOARD  MAIN  AUX  ATTRIBUTE  PROGRAM
```

PARAMETERS	SELECTION
PERSONALITY = NATIVE	NATIVE
ENHANCE = OFF	NY-60
COMM MODE = FULL DUPLX	912/920
MAIN/AUX = HOST/PRINT	910/910+
MONITOR MODE = OFF	950
LINE WRAP = ON	955
EDIT MODE = LINE	ADDS-AZ
FONT LOAD = ON	ADDS-VP60
SEND ACKNOWLEDGE = ON	DG-200
RECEIVE CR = CR	ADM-31
	IBM3101-2X
	IBM3162V
	NY-50/50+
	925
	PC-TERM
	HZ-1500
	IBM3101-1X
	VT100

Left/Right:Menu Up/Down:Item SP/BackSp:Selection Shift-Setup:Exit

General Menu Parameters

Table 3-2

Field	Definition
PERSONALITY	<p>NATIVE¹ and other terminal emulations: set-up menu and Chapter 4 show all selections; see Appendix C for code sets.</p> <p>CAUTION! Avoid loss of data! Selecting a new personality clears the screen and resets many terminal operating states. Read Chapter 4 for details.</p>
ENHANCE =	OFF ¹ or ON: Command sets of non-native personalities include additional 965 commands. (Chapter 4, Appendix C)
COMM MODE	Communication modes: half duplex, full duplex ¹ , block, local. (Chapter 9)
MAIN/AUX	HOST/PRINT ¹ sends data intended for the host out the main port and data intended for the printer out the auxiliary port; PRINT/HOST reverses configuration. (Chapter 9 for commands and Chapter 11 for port pin-outs)
MONITOR MODE	Mode ON means terminal displays control characters on the screen as characters instead of interpreting them as commands when mode is OFF ¹ . (Chapters 1, 5)
LINE WRAP	When the cursor reaches the end of the line during data entry, it wraps to the beginning of the next line (ON ¹) or remains at the end of line (OFF). (Chapter 7 -- autowrap mode)

¹Default value.

General Menu Parameters
Table 3-2 (continued)

Field	Definition
EDIT MODE	Editing commands affect data to the end of the LINE ¹ or end of the PAGE. (Chapter 7)
FONT LOAD	When personality and/or screen configuration change, character set automatically changes to match (ON ¹) or does not change (OFF). (Chapter 8)
SEND ACKNOWLEDGE	Mode ON ¹ means the terminal sends the ASCII ACK character (06h) after it completes operations that require the host to temporarily suspend transmission. (Chapter 9)
RECEIVE CR	The terminal responds to a carriage return code (CTRL-M) with a carriage return (CR) ¹ or a line feed and carriage return (LF/CR). (Chapter 7 -- new line mode)

¹Default value.

The Display Menu

The Display menu parameters affect the configuration and appearance of the screen. Table 3-3 gives a brief summary of each parameter and refers to sections of the manual that contain a detailed explanation.

Display Menu, Default Values



PRESS TO MOVE TO THE DISPLAY MENU

```
COMMAND  GENERAL  DISPLAY  KEYBOARD  MAIN  AUX  ATTRIBUTE  PROGRAM

PARAMETERS
COLUMNS = 80
LINES = 24
PAGE LENGTH = 1 x LINES
STATUS LINE = REVERSE
TOP LINE = STATUS
BOTTOM LINE = NONE
CURSOR TYPE = BLK STEADY
BACKGROUND = DARK
SCREEN SAVER = 10
SCROLL SPEED = JUMP

SELECTION
80 80/132 80 ECONOMY
132

Left/Right:Menu  Up/Down:Item  SP/BackSp:Selection  Shift-Setup:Exit
```

Display Menu Parameters

Table 3-3

Field	Definition
COLUMNS	Number of columns displayed on the screen (80 ¹ , 132, 80/132, 80 ECONOMY). (Chapters 1, 5)
CAUTION! Save screen data before selecting 80 economy mode (above) or changing the number of data lines (below). Enabling 80 economy mode or changing the number of data lines clears the screen, destroying any existing data.	
LINES	Number of data lines displayed on the screen (24 ¹ , 25, 42, 43, 48, 49). (Chapter 6)
PAGE LENGTH	Number of lines per page of terminal memory (1 X LINES ¹ , 2 X LINES, 4 X LINES, 1 + MEM). (Chapter 6)
STATUS LINE	Appearance (attribute) of the status line: NORMAL, REVERSE ¹ , UNDERLINE. (Chapter 5)
TOP LINE	Contents of the top information line: NONE, STATUS ¹ , USER 1, USER 2, FLABEL1, FLABEL2. (Chapter 10)
BOTTOM LINE	Contents of the bottom information line: NONE ¹ , STATUS, USER 1, USER 2, FLABEL1, FLABEL2. (Chapter 10)
CURSOR TYPE	Appearance (attributes) of the cursor: BLK BLINK, BLK STEADY ¹ , UNDL BLINK, UNDL STEADY, NONE. (Chapter 5)

¹Default value.

Display Menu Parameters
Table 3-3 (continued)

Field	Definition
BACKGROUND	Screen background: DARK ¹ or LIGHT. (Chapter 5)
SCREEN SAVER	Screen can go blank after 10 ¹ , 20, or 30 minutes of inactivity; or can remain displayed (mode OFF). (Chapter 5)
SCROLL SPEED	Data can scroll onto the screen at the rate of reception (JUMP ¹) or at a preset number of lines per second (SMOOTH 1, 2, 4, 8). (Chapter 5) NONE means the cursor wraps from the bottom of the page to the top, so data cannot scroll off the page and be lost. (Chapter 6 -- autoscroll mode)

¹Default value.

The Keyboard Menu

Keyboard modes and specific keys, plus the displayed character set, are controlled in the Keyboard menu. Table 3-4 gives a brief summary of each parameter and refers to the section of the manual that contains a detailed explanation.

Keyboard Menu, Default Values

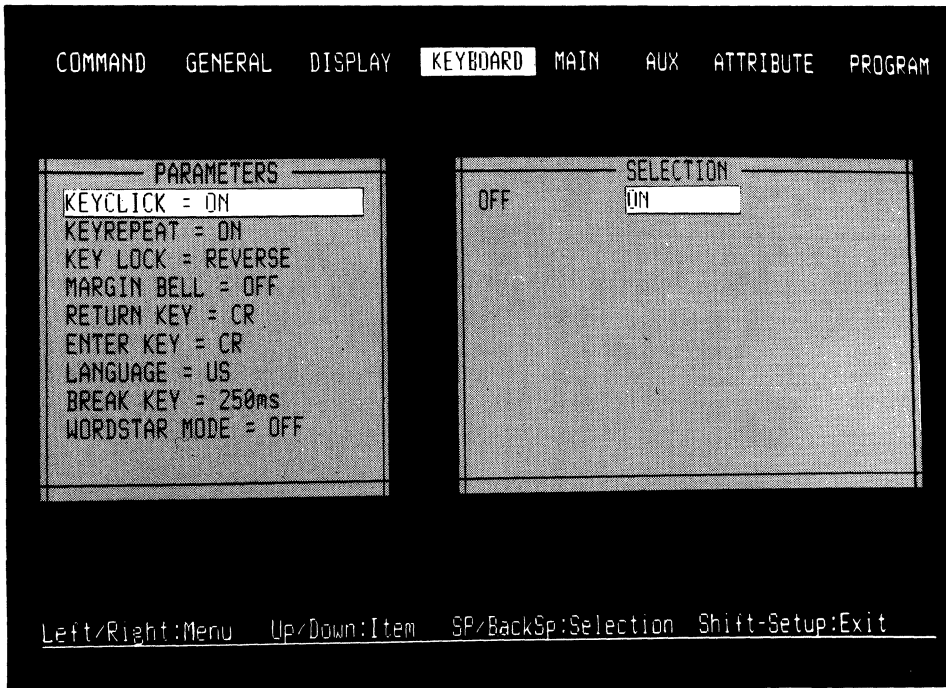

Keyboard Menu Parameters

Table 3-4

Field	Definition
KEYCLICK	Mode ON ¹ or OFF controls whether keys make a sound when pressed. (Chapter 5)
KEY REPEAT	Mode ON ¹ or OFF controls whether most keys repeat when held down for one-half second. (Chapter 5)
KEY LOCK	In CAPS ¹ mode, the SHIFT key uppercases letters, whether CAPS LOCK is engaged or released; in REVERSE mode, pressing SHIFT with a letter reverses the effect of CAPS LOCK. (Chapter 5)
MARGIN BELL	Mode ON or OFF ¹ controls whether the bell sounds when data entry reaches the margin column. (Chapter 5)
RETURN KEY	Key function can be carriage return (CR ¹), carriage return and line feed (CR/LF), or TAB. (Chapter 10)
ENTER KEY	Key function can be carriage return (CR ¹), carriage return and line feed (CR/LF), or TAB. (Chapter 10)
LANGUAGE	National character set can be US ¹ or one of 10 other international character sets. (Chapter 8)
BREAK KEY	Break signal can be 250 ms ¹ , 170 ms, 500 ms, or 2 sec. (Chapter 5)
WORDSTAR MODE	Mode ON or OFF ¹ controls whether editing and function keys send WordStar commands. (Chapter 10, Appendix D)

¹Default value.

The Main Menu

Set communication parameters for the main port in this menu.

Remember, if you select the PRINT/HOST value for the MAIN/AUX parameter in the General menu, this port handles data directed to a printer (e.g., a page print) and assumes the current print mode. In that case, the communication values you select in this menu should be appropriate for a terminal sending data to a peripheral.

Chapters 1 and 9 contain explanations of communication between a terminal and the host or peripheral devices.

Main Menu, Default Values

COMMAND GENERAL DISPLAY KEYBOARD **MAIN** AUX ATTRIBUTE PROGRAM

PARAMETERS	
BAUD RATE =	4800
DATA BIT =	8
STOP BIT =	1
PARITY =	NONE
XMT HANDSHAKE =	DTR
REC HANDSHAKE =	XON/XOFF
BUFFER THRESHOLD =	16
XMIT DELAY =	NONE
PARITY CHECK =	ON

SELECTION		
38.4K	50	75
110	135	150
300	600	1200
1800	2400	3600
4800	7200	9600
19.2K		

Left/Right:Menu Up/Down:Item SP/BackSp:Selection Shift-Setup:Exit

Main Menu Parameters
Table 3-5

Field	Definition
BAUD RATE ¹	Select from 50 to 38.4K; default 9600.
DATA BIT ¹	8 ² or 7; must agree with computer setting.
STOP BIT ¹	1 ² or 2.
PARITY ¹	NONE ² , ODD, EVEN, MARK, SPACE.
XMT HANDSHAKE	Handshaking signal accepted by the terminal when transmitting data can be XON/XOFF, DCD/DSR, or NONE ² .
REC HANDSHAKE	Handshaking signal sent by the terminal when receiving data can be XON/XOFF ² , DTR, NONE, or BOTH.
BUFFER THRESHOLD	Fill limit of the modem port buffer can be 16 ² , 32, 64, or 128.
XMT DELAY	Selects number of character delays per character transmitted (NONE ² , 1-7). Does not change the baud rate.
PARITY CHECK	Port parity checking function may be ON ² or OFF.

¹Must agree with the setting of the communicating device (host or peripheral).

²Default value.

The AUX Menu

Set communication parameters for the auxiliary port in this menu.

Remember, if you select the PRINT/HOST value for the MAIN/AUX parameter in the General menu, this port handles data directed to the host (e.g., a block send) and assumes the current host communication mode. In that case, the communication values you select in this menu should be appropriate for a terminal communicating with a computer.

Chapters 1 and 9 contain explanations of communication between a terminal and the host or peripheral devices.

AUX Menu, Default Values

COMMAND GENERAL DISPLAY KEYBOARD MAIN **AUX** ATTRIBUTE PROGRAM

PARAMETERS	
BAUD RATE =	1200
DATA BIT =	8
STOP BIT =	1
PARITY =	NONE
XMT HANDSHAKE =	DCD
REC HANDSHAKE =	XON/XOFF
BUFFER THRESHOLD =	16
XMIT DELAY =	NONE
PARITY CHECK =	ON

SELECTION		
38.4K	50	75
110	135	150
300	600	1200
1800	2400	3600
4800	7200	9600
19.2K		

Left/Right:Menu . Up/Down:Item SP/BackSp:Selection Shift-Setup:Exit

AUX Menu Parameters
Table 3-6

Field	Definition
BAUD RATE ¹	Select from 50 to 38.4K; default 1200.
DATA BIT ¹	8 ² or 7; must agree with computer setting.
STOP BIT ¹	1 ² or 2.
PARITY ¹	NONE ² , ODD, EVEN, MARK, SPACE.
XMT HANDSHAKE	Handshaking signal accepted by the terminal when transmitting data can be XON/XOFF, DTR, NONE or BOTH ² .
REC HANDSHAKE	Handshaking signal sent by the terminal when receiving data can be XON/XOFF, DSR ² , NONE, or BOTH.
BUFFER THRESHOLD	Fill limit of the auxiliary port buffer can be 16 ² , 32, 64, or 128.
XMT DELAY	Selects number of character delays per character transmitted (NONE ² , 1-7). Does not change the baud rate.
PARITY CHECK	Port parity checking function may be ON ² or OFF.

¹Must agree with the setting of the communicating device (host or peripheral).

²Default value.

The Attribute Menu

The Attribute menu parameters affect the nature and extent of visual attributes and specify the attributes of write-protected characters. See Chapter 5 for a detailed explanation of visual attributes.

Attribute Menu, Default Values

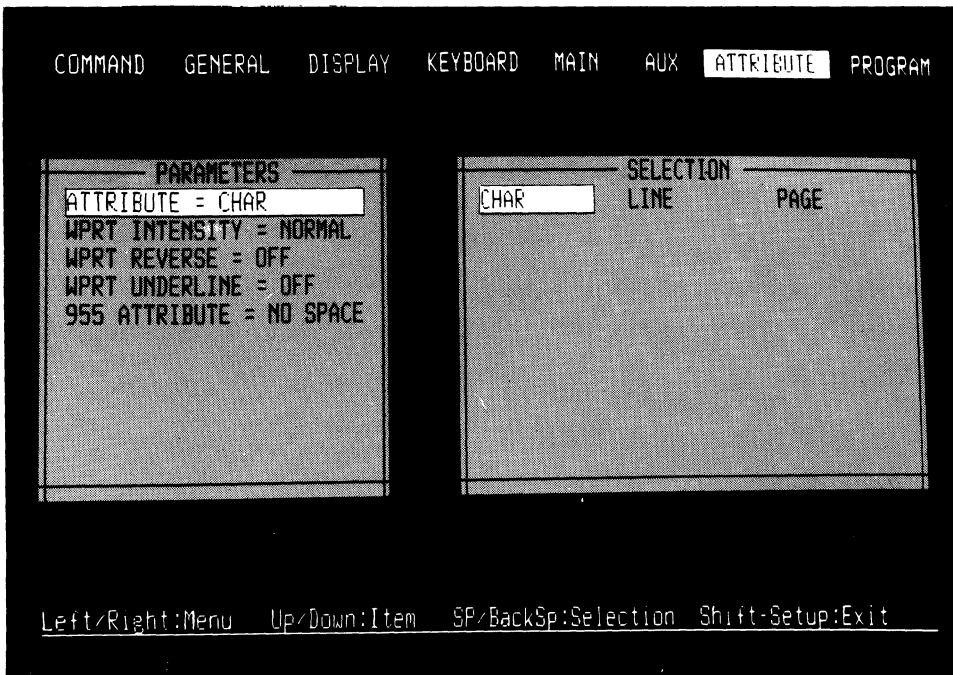

Attribute Menu Parameters
Table 3-7

Field	Definition
ATTRIBUTE	Visual attributes may be CHARACTER, LINE, or PAGE ¹ based. CAUTION! Changing between character and line or page attributes clears the screen! NOTE: Character-based attributes are available in personalities 965, WY-60, VPA2, and DG200. Field-based attributes are available in personalities 965, 955, 910/910+, 912/920, 925/905, 950, WY-60, WY-50/50+, Hazeltine 1500, and ADM 31.
WPRT INTENSITY	Write-protected characters may be displayed in NORMAL or DIM ¹ intensity.
WPRT REVERSE	The reverse attribute of write-protected characters may be OFF ¹ or ON.
WPRT UNDERLINE	The underline attribute of write-protected characters may be OFF ¹ or ON.
955 ATTRIBUTE	Line- or page-based attributes may occupy NO SPACE on screen or a SPACE ¹ .

¹Default value.

THE PROGRAM MENUS

The Program menus consist of five submenus, named in the SELECTION window when you enter each submenu. The remaining display in the PARAMETERS window contains fields of the current submenu.

REMEMBER: To display other submenus, press the **space bar**. To move through the fields in each submenu, press the **up/down arrows**.

All reprogramming is also explained in Chapter 10, except delimiter reprogramming, which is covered in Chapter 9.

The Function Key Submenu

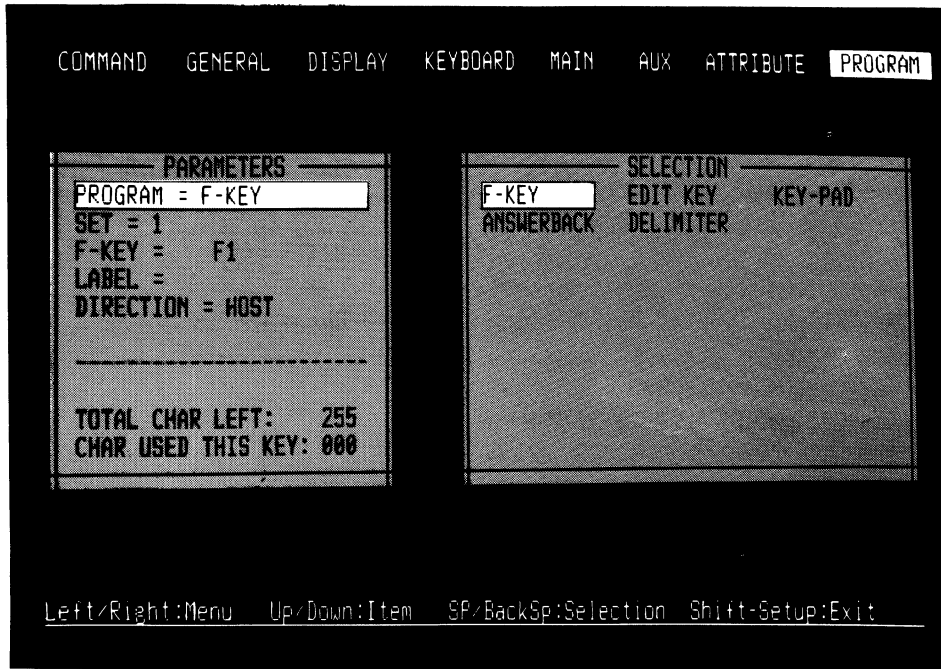

The terminal has four logical sets of function keys. The 16 function keys in each set can send 32 separate messages, since pressing a key alone sends a message, and pressing the same key with SHIFT sends a different message. So a total of 128 function keys are available.

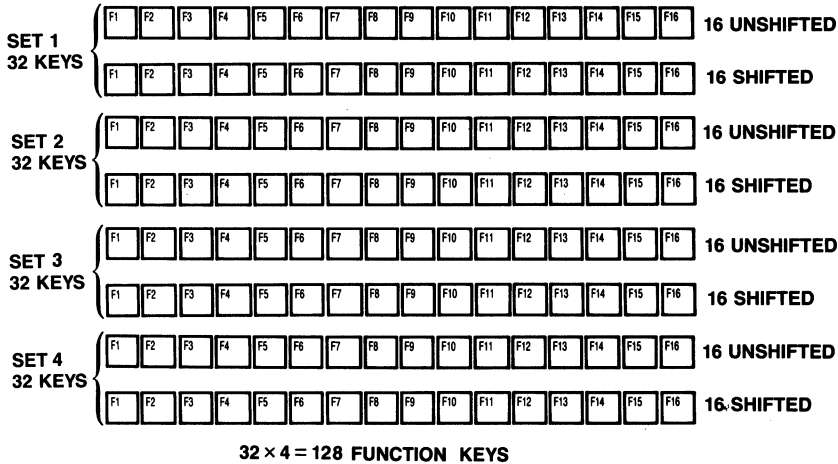

Each function key set holds up to 256 characters (bytes), apportioned among the 32 keys as you wish. You can load any sort of message or command into a function key, such as your logon sequence, an access code, or frequently typed words and phrases. You can reprogram the function keys here in set-up, or your program may do it for you.

Follow these steps to reprogram the function keys:

1. Move the highlight cursor to the SET field.
2. Press the space bar until the number of the desired function key set (1, 2, 3, 4) is highlighted.

NOTE: Be aware that the last programmed (current) function key set is active when you leave set-up. Also be aware that the current function key set is not automatically saved in nonvolatile memory when you leave set-up. You must save the set as you would any other set-up value, by invoking the SAVE command in the Command set-up menu. If you don't save the set, it is active only until you reset the terminal.

3. Now move to the F-KEY field.
4. Press any unshifted or shifted function key to select it for reprogramming. The key number appears in the PARAMETERS window, and the current message appears in the SELECTION window. If you press a shifted key, an s appears in front of the key number.
5. Press the numeric keypad ENTER key to start reprogramming the message.

Use the keys listed at the bottom of the screen to edit your message and move the cursor. The keys work as follows:

Arrow keys Move the cursor around in the message.

CHAR Toggles between insert and write-over modes,
INSERT as indicated at the bottom of the screen.

CE Clears the current message.

CAUTION! Pressing this key destroys the function key message currently displayed in the set-up window. Be sure this is what you want to do. If you press CE by mistake, you can restore your previous message by immediately pressing ESC.

ESC Aborts the reprogramming session; message returns to previous saved message.

ENTER Begins and ends a reprogramming session; saves the current message in nonvolatile memory.

6. Enter the new message. It can be any combination of alphanumeric and control characters. Press control keys (CTRL + *key*) to enter commands in the message. For example, to enter the carriage return character, press CTRL-M. Type CTRL-[to enter the ESC character in an escape sequence.

If you make a mistake, move the cursor with the arrow keys back to the position of the error and correct the mistake.

Each function key set has a total memory capacity of 256 bytes, which can be distributed any way among the keys. Two fields at the bottom the PARAMETERS window show the number of characters remaining in the function key set memory and the number of characters programmed into the current key. As you program, the figures update. When memory is full, the terminal beeps.

7. Press ENTER to end the loading process and save the message.
8. Move to the LABEL field and press ENTER. Type in up to nine characters (in 80-column mode) or seven characters (in 132-column mode) as a label for the reprogrammed key. Use the keys described in Step 5 to edit the label. (Labels for keys F8 and F16 can contain only eight characters.)

NOTE: Enable display of the function key labels on screen in the Display set-up menu.

9. The DIRECTION field lets you determine where the message goes when you press a function key:

Value	Destination
HOST	Message goes to the computer
LOCAL	Message goes to the terminal (screen)
NORMAL	Message destination is determined by the communication mode
PRINTER	Message goes to the printer

The message destination, like the function key message, is automatically saved in nonvolatile memory.

The Editing Key Submenu

Editing keys send ASCII characters (codes) that control editing operations, data transmission, and cursor movement. This submenu lets you change the codes sent by the editing keys listed in the PARAMETERS window and specify their destination (i.e., editing key mode). Your program can also change the key codes and destination mode.

NOTE: Only the main keyboard TAB key is reprogrammable in this submenu. Reprogram the numeric keypad TAB key in the KEYPAD submenu.

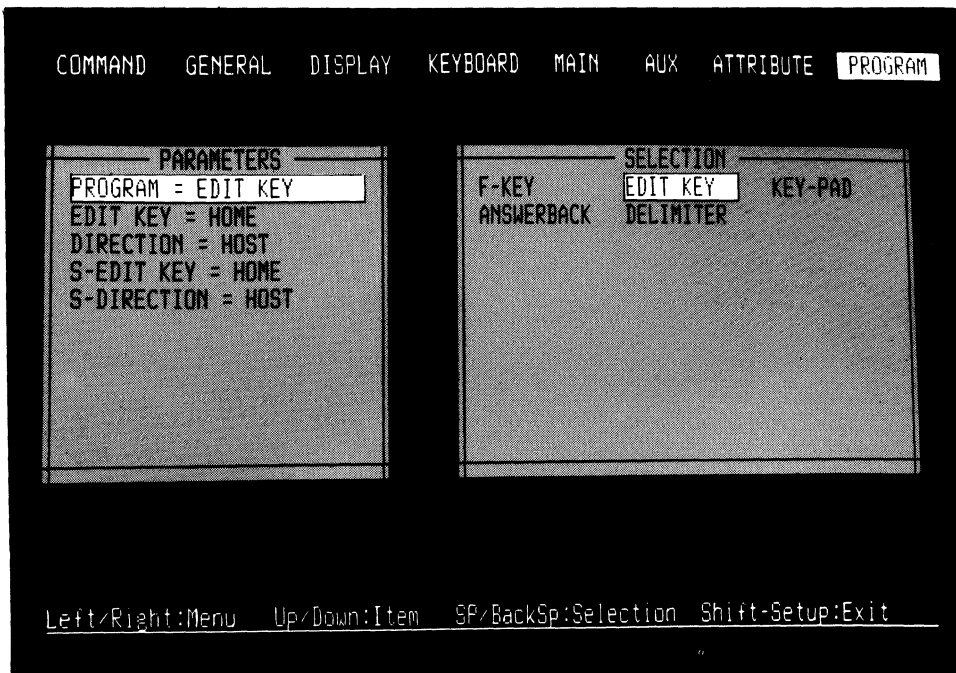

The steps below tell how to reprogram the editing keys and set the editing key mode. Procedures similar to reprogramming the function keys are not repeated in full here; refer to the instructions for reprogramming function keys for a complete explanation.

1. Enter the Program set-up menu and press the space bar to display the EDIT KEY submenu.
2. Move the cursor down to the EDIT KEY = or S-EDIT KEY = (for the shifted keys) field. A list of editing keys appears in the SELECTION window, and the current code of the highlighted key appears in the CONTENT: field at the bottom of the window. An asterisk (*) in front of the code indicates the code display is the default code.
3. Press the space bar to highlight the desired key.
4. Press ENTER to start reprogramming the key.

You can use the keys listed at the bottom of the screen to edit your message and move the cursor. See the explanation of key operations in the function key reprogramming section for more information.

5. Enter up to five bytes as the new key code. The new codes display in the CONTENT: field as you enter them.
6. Press ENTER to end the loading process. This automatically saves the new key contents in nonvolatile memory.
7. The DIRECTION field lets you determine where the key code goes when you press an editing key:

Value	Destination
HOST	Message goes to the computer
LOCAL	Message goes to the terminal (screen)
NORMAL	Message destination is determined by the communication mode

The message destination, like the key code, is automatically saved in nonvolatile memory.

The Keypad Submenu

The numeric keypad submenu is very similar to the editing key submenu. It lets you change the characters sent by the keys in numeric keypad. You can reprogram all the unshifted keys, plus the shifted TAB, CE, and ENTER keys. The DIRECTION field lets you specify the destination of the shifted keys. Your program can also do this reprogramming, but cannot specify the direction of the keys.

NOTE: Only the numeric keypad TAB key is reprogrammable in this submenu. Reprogram the main keyboard TAB key in the EDIT KEY submenu.

COMMAND GENERAL DISPLAY KEYBOARD MAIN AUX ATTRIBUTE PROGRAM

PARAMETERS	SELECTION
PROGRAM = KEY-PAD	F-KEY
KEY = 7	EDIT KEY
DIRECTION = HOST	ANSWERBACK
S-KEY = TAB	DELIMITER
S-DIRECTION = HOST	KEY-PAD

Left/Right:Menu Up/Down:Item SP/BackSp:Selection Shift-Setup:Exit

The steps below tell how to reprogram the numeric keypad keys. Procedures similar to reprogramming the function keys are not repeated in full here; refer to the instructions for reprogramming function keys for a complete explanation.

1. Enter the Program set-up menu and press the space bar to display the KEYPAD submenu.
2. Move the cursor down to the KEY = or S-KEY = (for the shifted keys) field. A list of keys appears in the SELECTION window, and the current code of the highlighted key appears in the CONTENT: field at the bottom of the window.
3. Press the space bar to highlight the desired key.
4. Press ENTER to start reprogramming the key.

You can use the keys listed at the bottom of the screen to edit your message and move the cursor. See the explanation of key operations in the function key reprogramming section for more information.

5. Enter up to five bytes as the new key code. The new codes display in the CONTENT: field as you enter them.
6. Press ENTER to end the loading process. This automatically saves the new key contents in nonvolatile memory.
7. The DIRECTION field lets you determine where the key code goes when you press one of the three shifted keys:

Value	Destination
HOST	Message goes to the computer
LOCAL	Message goes to the terminal (screen)
NORMAL	Message destination is determined by the communication mode

The message destination, like the key code, is automatically saved in nonvolatile memory.

The Answerback Submenu

The terminal sends an answerback message to the computer in response to a received command. The default 965 answerback message is blank.

You can load an answerback message of up to 31 characters in this submenu. You can then elect to display or conceal the message.

CAUTION! Once you conceal the answerback message, you cannot display it again.

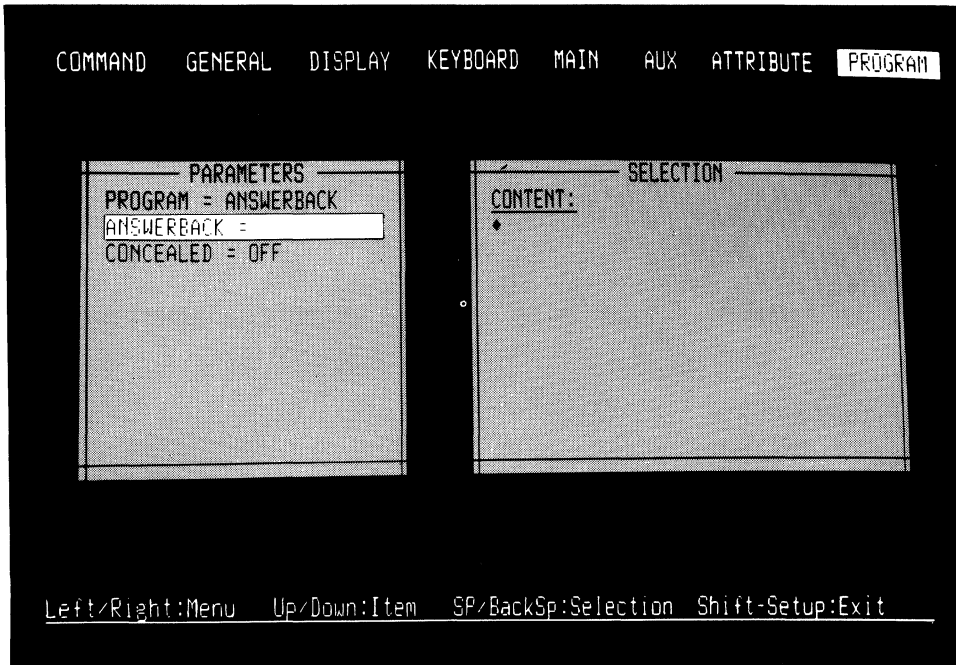

The steps below tell how to load an answerback message.

1. Enter the Program set-up menu and press the space bar to display the ANSWERBACK submenu.
2. Move the cursor down to the ANSWERBACK = field.
3. Press ENTER to start reprogramming the key.

You can use the keys listed at the bottom of the screen to edit your message and move the cursor. See the explanation of key operations in the function key reprogramming section for more information.

4. Enter up to 31 bytes as the new message. Press ENTER to end the entry.
5. To conceal the message, move the cursor down to the CONCEALED field and press the space bar to highlight the ON value.

CAUTION! Once you select ON, you cannot redisplay or reprogram the answerback message. Pressing the space bar again to select OFF destroys the message.

6. To reprogram a concealed message, select CONCEALED = OFF. This destroys the existing message. Then return to the ANSWERBACK = field and load a new message.

The Delimiter Submenu

The terminal automatically inserts field, line, and message delimiters when it transmits text to the computer. Chapter 9 describes the function of delimiters in transmissions to the computer.

You can reprogram the transmission delimiters in this submenu.

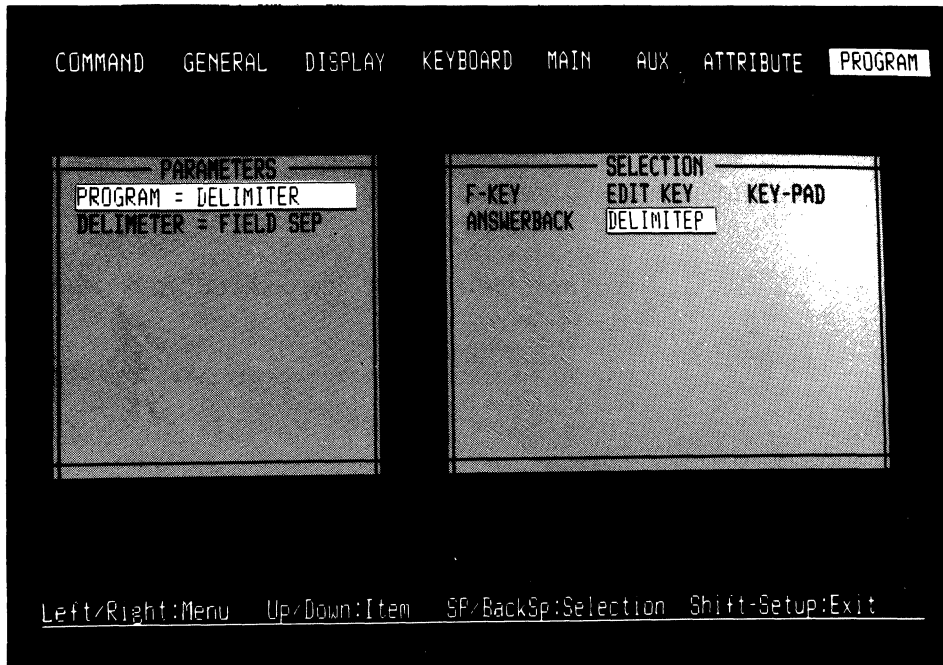

The steps below tell how to reprogram the delimiters.

1. Enter the Program set-up menu and press the space bar to display the DELIMITER submenu.
2. Move the cursor down to the DELIMITER = field.
3. Press the space bar to select the delimiter you want to reprogram.
4. Press ENTER to start reprogramming the delimiter.

You can use the keys listed at the bottom of the screen to edit the code and move the cursor. See the explanation of key operations in the function key reprogramming section for more information.

4. Enter 2 bytes as the new delimiter. Press ENTER to end the code.

4 INTRODUCTION TO PROGRAMMING

Entering Commands	4.2
Sending Commands From the Host	4.2
Entering Commands From the Keyboard	4.2
Command Format	4.4
Personality Modes	4.5
Selecting the Terminal Personality	4.5
Enhanced Personality Mode	4.8
Saving and Resetting Values	4.9
Saving Set-Up Values	4.9
Resetting the Terminal	4.9

4 INTRODUCTION TO PROGRAMMING

This chapter introduces the basics of programming the 965 terminal. It then presents the commands for changing the terminal personality, saving reprogrammed set-up values, and resetting the terminal. The following chapters present the remaining 965 revision A firmware native mode commands.

CAUTION! Avoid loss of data! When you select a new terminal personality, the screen clears and many values reset. Read the information in this chapter about selecting a personality and saving reprogrammed set-up values.

The 965 command set is a superset of the TeleVideo 955 terminal commands. Most native mode commands follow the format of the industry-standard TeleVideo 950/955 command sets. But some terminal functions are also controlled by duplicate commands structured in the style of Wyse 60 commands. These duplications are intended to adapt the 965 to a broad range of programming environments.

The 965 revision A firmware has 11 non-native personality modes you may select in set-up or by a command presented later in this chapter. Additional personalities will be implemented in revision B and above firmware.

ATTENTION, PROGRAMMERS: Avoid frustration! If you are not experienced in sending commands directly (locally) from the keyboard, read the subsection called "Entering Commands From the Keyboard." It starts on the next page.

ENTERING COMMANDS

The terminal responds to commands sent from the host or entered at the keyboard.

Sending Commands From the Host

How you incorporate commands into your programs depends on your programming language. The 965 responds to control codes and escape sequences from the host regardless of your programming language format and syntax.

The multitude of languages and syntaxes makes it impossible to show you in this manual how to incorporate commands in each program. If you need help with the proper syntax, refer to the documentation for your programming language.

Appendix B contains an ASCII chart that shows the ASCII characters and corresponding numeric values in various systems.

Entering Commands From the Keyboard

Sending programming commands from the keyboard lets an operator control many aspects of terminal operation not available in set-up.

Two factors affect the response of the 965 to commands from the keyboard:

- * Communication mode
- * Correct keystrokes

Communication mode To ensure that commands from the keyboard go to the terminal, enable block or local communication mode. If you enter commands at the keyboard during full or half duplex communication mode, the results are unpredictable. The computer receives the commands, and its response depends on the operating system and application program.

However, you can send escape sequences to the terminal during full or half duplex mode by entering the commands with the LOC ESC key (SHIFT-ESC) instead of ESC. This sends commands to the terminal only.

Correct keystrokes Always press the CTRL key first and *hold it down* while you press the other key (as you would the SHIFT key). Always press *and release* the ESC key before pressing the next key.

Enter characters exactly as shown. Notice whether the command requires an upper- or lowercase character, a number **one** or a lowercase **L**, a **zero** or an uppercase **O**. Make sure the CAPS LOCK key is not locked.

Commands are printed in this manual with a space between the characters. Do *not* type this space as part of the sequence; it is included only for clarity. For example, the sequence

ESC c

involves pressing only the ESC key, then a lowercase c.

Command Format

This manual presents programming commands in a format that shows the section title, values selectable in set-up, default values, command function, ASCII command characters, and variable values.

For example, look at the command to change the cursor style:

Cursor Style

SET-UP
DEFAULT Ps = 1
ESC . Ps

Select cursor style

Ps	Cursor Attribute
0	Not displayed
1	Blinking block
2	Steady block
3	Blinking underline
4	Steady underline
5	Blinking block

Cursor Style is the title of the section. Each section contains one or more commands. All the commands that affect one terminal function are grouped under a section title, listed in the table of contents.

SET-UP indicates that the parameter is also selected in set-up.

DEFAULT Ps = 1 gives the default terminal condition.

Select cursor style defines the function of the command.

ESC . Ps is the command in ASCII characters. Appendix B contains charts to convert ASCII characters to binary, decimal, octal, or hexadecimal values.

Variables in commands are usually shown as **Ps**, to represent a selective value. The effects of variables are described in the text following each command.

PERSONALITY MODES

Selecting the Terminal Personality

SET-UP
DEFAULT Ps = 6
ESC [10 ; Ps v

Select the terminal personality

Ps	Personality	Ps	Personality
0	955	9	ADDS A2
1	950	10	ADDS VP60 ¹
2	Wyse 50/50+	11	Hazeltine 1500
3	912/920	12	DG 200
4	910/910+	13	ADM 31
5	925/905	14	IBM 3101-1X ¹
6	965 native mode	15	IBM 3101-2X ¹
7	Wyse 60	16	IBM 3162V ¹
8	PC Term ¹	17	VT100 ¹

STOP! This command can cause loss of data! Save all data before sending this command.

When you select the personality mode, the screen clears and many operating modes reset to a state compatible with the *new* personality. Table 4-1 shows the states to which the terminal resets when it enters various personalities. See the command above for each personality's value of Ps.

Reprogrammed function and editing keys retain their reprogramming when you select a new terminal personality unless you elect in set-up to return them to the default codes of the new personality.

Appendix C contains a summary of code sets for the terminal personalities.

NOTE: Set-up values not listed in Table 4-1 remain the same when the personality mode changes. This means you can enable a terminal feature in native mode that is not normally available in some other personality, then select a new personality mode and retain the feature.

¹Not implemented in Rev. A firmware.

Terminal Operating States After Personality Mode Reset
Table 4-1

Mode/Condition	State	Personality Ps Value
DISPLAY		
Visual attribute setting	Normal	All
Visual attribute base	Character Page Line	7,8,9,12,17 0,1,2,3,6,10,11 4,5,13
Write protect attribute	Half intensity	All
Line attribute	Single high/wide	All
Display (on/off)	On, cleared	All
Cursor display (on/off)	On	All
Column width	80	All
Number of lines per page	24 25	All but 8 8
Number of lines per screen	24 25	All but 8 8
Line lock	All lines unlocked	All
Scrolling regions	Clear	All
Split screen	Clear	All
Monitor mode	Off	All
Auto scroll mode	On	All
Auto page mode	Off	All
Autowrap mode	On (wrap) Off (no wrap)	All others 17

Terminal Operating States After Personality Mode Reset
Table 4-1 (continued)

Mode/Condition	State	Personality Ps Value
EDITING MODES		
Receive CR mode (CR, CR-LF)	CR	All
Tab stops	Clear all Set 8 column stops	All others 4,17
Edit mode (page, line)	Line	All
Protect mode	Off	All
Insert/replace mode	Replace	All
KEYBOARD		
Wordstar mode	No reset	All
Application mode	No reset	All
Function and editing key reprogramming	No reset unless selected in set-up	All
CHARACTER SETS		
Graphics mode	Off	All
Replacement character	Space	All
Font bank assignments	Reset to default	All
Primary/secondary character set definitions	Reset to default	All

Terminal Operating States After Personality Mode Reset
Table 4-1 (continued)

Mode/Condition	State	Personality Ps Value
HOST/PRINTER COMMUNICATIONS		
ACK mode	On	0,1,3,4,5,6,7
	Off	All others
Print modes	Off	All
Page print page flip mode	On	1,5
	Off	All others
Answerback message	No reset	All

Enhanced Personality Mode

SET-UP
DEFAULT = Off
ESC [= 20 h
ESC [= 20 l

Enable enhanced mode

Disable enhanced mode

Enhanced mode provides additional commands in some terminal personalities. Appendix C indicates enhanced mode commands by setting them in bold type.

NOTE: Enable enhanced mode during 965 native mode. Then the set-up value is retained when you switch to another terminal personality.

SAVING AND RESETTING VALUES

Saving Set-Up Values

SET-UP

Save current set-up values in nonvolatile memory

ESC [0 ; 1 }

Most reprogrammed operating values are not saved in nonvolatile memory. (Exceptions, such as key contents, answerback message, send delimiters, and page print termination character, are noted in their descriptions.) This command saves reprogrammed values that can also be changed in set-up and that are not automatically saved in nonvolatile memory. The section earlier in this chapter called "Command Format" tells how to identify set-up values.

Resetting the Terminal

SET-UP

Reset operating values to factory default values

ESC ~ 0

CAUTION! This command erases any reprogramming you may have loaded into nonvolatile memory.

Reset operating values to nonvolatile memory values

ESC ~ 1

Reset function keys to factory default values

ESC ~ 2

Reset editing and numeric keypad keys to factory default values

ESC ~ 3

These commands void any values previously changed by commands from the keyboard or computer that have not been saved.

Table 4-2 summarizes methods for resetting some or all terminal operating values. Be careful when you reset the terminal: You can lose operating values you have reprogrammed or selected in set-up.

Summary of Reset Methods
Table 4-2

Command/ Key	Clears Screen?	Effects
ESC ~ 0	Yes	Resets software; returns nonvolatile memory to factory default values.

CAUTION! This sequence permanently destroys any reprogrammed values in nonvolatile memory.

ESC ~ 1 or power off and back on	Yes	Returns the terminal to nonvolatile memory values (including latest set-up menu values and reprogrammed function keys). Unlocks the keyboard.
ESC ~ 2	No	Restores codes sent by function keys to factory default values.
ESC ~ 3	No	Restores codes sent by editing and numeric keypad keys to factory default values.

5 KEYBOARD AND SCREEN

The Keyboard	5.1
Locking/Unlocking the Keyboard	5.1
Auto Repeat Mode	5.1
Keyclick	5.2
Disabling Specific Keys	5.2
Selecting the BREAK Key Signal	5.2
CAPS LOCK Mode	5.3
Caps Reverse Mode	5.3
The Bell	5.4
Sounding the Bell	5.4
Selecting the Bell Column	5.4
Margin Bell Mode	5.4
Screen Appearance	5.5
Visibility	5.5
Background	5.5
Refresh Rate	5.5
Screen Saver	5.5
Cursor Appearance	5.6
Visual Attributes	5.7
Visual Attribute Types	5.7
Selecting the Attribute Type	5.8
Selecting the Attribute Base	5.9
Defining Visual Attributes	5.9
Normal Intensity Mode	5.10
Filling a Rectangle with Attributes	5.10
Information Area Attributes	5.11
Status Line Attributes	5.11
Write-Protected Area Attributes	5.12
Line Appearance	5.13
Selecting the Number of Columns per Line	5.13
80-Column Economy Mode	5.13
Line Attributes	5.14
Test Displays	5.15
Self Test	5.15
Monitor Mode	5.15

5 KEYBOARD AND SCREEN

This chapter covers the following topics:

- * Keyboard and bell functions
- * Screen appearance
- * Character and cursor attributes in the text display
- * Attributes of the information lines
- * Line attributes

Chapter 10 contains information about loading and displaying the information line messages.

THE KEYBOARD

Locking/Unlocking the Keyboard

	DEFAULT = Unlocked
Lock (disable) the keyboard	ESC #
Unlock (enable) the keyboard	ESC "

When the keyboard is locked, only the SHIFT, CTRL, and SETUP keys operate. To unlock the keyboard, enter set-up and execute CLEAR COMMUNICATION, or reset the terminal. See Table 4-1 for the effects of resetting.

Auto Repeat Mode

	SET-UP
	DEFAULT = On
Auto repeat on	ESC = 8 h
Auto repeat off	ESC = 8 /

Repeat on Keys (except CLEAR SPACE, HOME, SEND, PAGE, CE, ENTER, RETURN, ESC, LOC ESC, PRINT, LINE ERASE, PAGE ERASE, and the function keys) repeat when pressed for more than one-half second.

Repeat off No keys repeat.

Keyclick	SET-UP
	DEFAULT = On
Keyclick on	ESC >
Keyclick off	ESC <

This command temporarily overrides the set-up menu value.

Disabling Specific Keys	SET-UP
	DEFAULT = Enabled
Disable specified key(s)	ESC [= Ps ... Ps l
Enable specified key(s)	ESC [= Ps ... Ps h

Ps	Key
11	SET-UP
12	ESC
13	CLEAR SPACE
14	BREAK

Disabling these keys prevents operator interference.

Selecting the BREAK Key Signal

Select the BREAK key signal	DEFAULT Ps = 2
	ESC [15 ; Ps v

Ps	Signal
0	Disabled
1	170 ms
2	250 ms
3	500 ms
4	2 sec

The BREAK key holds the communication line (pin 2 of the main port RS-232C connector) in the 0 (low) state for a specified time. How your computer responds to the signal depends entirely on its program. A break signal may disconnect a modem.

CAPS LOCK Mode

DEFAULT = Disabled

Disable CAPS LOCK mode

ESC [= 26 /

Enable CAPS LOCK mode

ESC [= 26 h

During CAPS LOCK mode, alphanumeric keys generate uppercase letters, as if the CAPS LOCK key were engaged. When caps reverse mode is also enabled, pressing an alphanumeric key with SHIFT generates a lowercase key (see the table below).

Caps Reverse Mode

SET-UP

DEFAULT = Normal

Disable caps reverse mode

ESC [= 25 /

Enable caps reverse mode

ESC [= 25 h

The following chart shows the difference between normal and caps reverse mode:

Letter Keys Plus SHIFT & CAPS LOCK	Mode	
	Normal	Reverse
Alone	lowercase	lowercase
With SHIFT	UPPERCASE	UPPERCASE
Alone, CAPS LOCK engaged or CAPS LOCK mode enabled	UPPERCASE	UPPERCASE
With SHIFT, CAPS LOCK engaged or CAPS LOCK mode enabled	UPPERCASE	lowercase

Enabling CAPS LOCK mode (see the previous command) has the same effect during caps reverse mode as engaging the CAPS LOCK key.

The CAPS LOCK key only affects the letter keys. All other number and symbol keys must be pressed with SHIFT to generate the upper key symbol.

THE BELL

Sounding the Bell

Sound the terminal bell

CTRL G

You can insert this command whenever you want the terminal bell to sound.

Selecting the Bell Column

Load the margin bell column

CTRL W

This command sets the margin bell column at the current cursor location. The bell sounds when the cursor reaches the defined column during keyboard data entry.

The default bell columns are 72 in 80-column mode and 124 in 132-column mode.

Margin Bell Mode

SET-UP

DEFAULT = Disabled

Enable the margin bell

ESC [= 4 h

Disable the margin bell

ESC [= 4 l

When the margin bell is enabled, it sounds when the cursor reaches the bell column, determined by the command CTRL W (above), during data entry.

SCREEN APPEARANCE

Visibility

	DEFAULT = On
Screen display on	ESC n
	ESC . 9
Screen display off	ESC o
	ESC . 8

Turning the display off does not clear data from the screen; it merely hides it.

Background

	SET-UP
	DEFAULT = Dark
Dark background	ESC d
Light background	ESC b

The screen background is either light with dark characters or dark with light characters. If you select the screen background currently defined in set-up, no change occurs.

Refresh Rate

	DEFAULT = 60 Hz
Select 60-Hz screen refresh rate	ESC [= 16 l
Select 50-Hz screen refresh rate	ESC [= 16 h

Some power systems, usually international systems running at 230V, may require 50 Hz to avoid screen flicker.

Screen Saver

SET-UP
DEFAULT Ps = 0
ESC [8 ; Ps v

Select the screen saver time

Ps	Effect
0	No screen saver
1	Screen blanks after 10 minutes of inactivity
2	Screen blanks after 20 minutes of inactivity
3	Screen blanks after 30 minutes of inactivity

If the screen receives no data from the keyboard or computer for the duration selected with this command, it goes blank to conserve the phosphor coating inside the face of the screen. Any data entry from the keyboard or host makes the display reappear.

NOTE: Press CTRL-CLEAR SPACE to enable screen saver immediately from the keyboard.

Cursor Appearance

SET-UP
DEFAULT Ps = 1
ESC . Ps

Select the cursor appearance

Ps	Cursor Appearance
0	Invisible
1	Blinking block
2	Steady block
3	Blinking underline
4	Steady underline
5	Blinking block

VISUAL ATTRIBUTES

Visual attributes determine the appearance of characters on the screen. The 965 has a wide range of visual attribute choices. If you are unfamiliar with the characteristics of visual attributes, read the following pages.

Visual Attribute Types

The 965 native mode gives you a choice of field-based or character-based visual attributes. The field attributes can be line- or page-based. The following paragraphs discuss each type of attribute.

CAUTION! Changing between field- and character-based attributes clears the display, causing loss of all unsaved data.

Character-based Attributes are a function of *time*. Characters entered anywhere on the screen are displayed in the *currently defined* attribute. When you redefine the attribute, characters displayed in previously defined attributes do not change. Only subsequently entered characters display the new attribute.

For example, suppose you enable the blinking underline attribute and enter a character, a space, and a character. Then you change to reverse attribute and enter a character in the space between the two blinking underlined characters. You end up with a blinking underlined character, a reversed character, and another blinking underlined character.

Field-based Attributes are a function of *location*. Any time you enter a character within an attribute field, it has the attribute of that field. The display may contain any number of different attributes in various locations. An attribute field extends to the end of the line or page, or until it encounters another attribute.

For example, you could define a field of reverse attributes. No matter when you type in the field, the entry appears in reverse-attribute characters. If the field is followed by a field of underline attributes, positioning the cursor anywhere in the reverse-attribute field and entering a normal attribute creates a field of normal attributes from the cursor to the beginning of the underline attribute field.

Field-based attributes are write protected. They may be embedded or nonembedded, and the fields may be line-based or page-based:

- * **Embedded** Visual attributes occupy a character space. Entering a character in that space destroys the attribute (unless protect mode is enabled, since attributes are write-protected).
- * **Nonembedded** Visual attributes do not occupy a character space. The first character you enter, **where the attribute starts or any place else on the page**, does not destroy the attribute. But **after you enter that first character**, entering a character where the attribute starts destroys the attribute. Since attributes are write protected, you can avoid destroying them by turning on protect mode when you want to re-enter a character where an attribute starts.
- * **Line-based** The attribute field, unless previously disabled, automatically terminates at the end of the current line.
- * **Page-based** The attribute field, unless previously disabled, extends to the end of the page.

Selecting the Attribute Type

SET-UP
DEFAULT Ps = 0
ESC F Ps

Select the attribute type

Ps	Attribute Type
0	Embedded field
1	Nonembedded field
2	Character

CAUTION! This command can cause loss of data! Changing between field and character attributes clears the display.

If the terminal is already in field attribute mode, changing between embedded and nonembedded attributes does not clear the display.

This command controls the attribute type for both the text and information areas. See the previous discussion of attributes for an explanation of each attribute type.

Selecting the Attribute Base

Select page-based field attributes
Select line-based field attributes

SET-UP
DEFAULT = Page
ESC [= 2 h
ESC [= 2 /

CAUTION! These commands can cause loss of data! Changing from character to field attributes clears the display.

If the terminal is already in field attribute mode, changing between page-based and line-based attributes does not clear the display.

Defining Visual Attributes

Define visual attribute(s)

DEFAULT Ps = 0
ESC G Ps

Ps		Attribute
F.I.	H.I.	
0	p	Normal (selected by set-up or command)
1	q	Invisible normal video
2	r	Blink
3	s	Invisible blink
4	t	Reverse video (reverse of normal selection)
5	u	Invisible reverse
6	v	Reverse and blink
7	w	Invisible reverse and blink
8	x	Underline
9	y	Invisible underline
:	z	Underline and blink
;	{	Invisible underline and blink
,		Reverse and underline
=	}	Invisible reverse and underline
>	~	Reverse and underline and blink
?	DEL	Invisible reverse and underline and blink

This command defines the visual attributes for unprotected display text. It does not affect write-protected characters or the information lines.

NOTE: Half intensity attributes are available only for character-based attributes.

The invisible attribute affects only the appearance of the characters: the cursor is still visible and data is transmitted to the computer.

Normal Intensity Mode

Normal attribute is half intensity
Normal attribute is full intensity

SET-UP
DEFAULT = Full
ESC | = 5 h
ESC | = 5 /

This command resets the normal visual attribute to half-intensity. It does not reset the half-intensity attribute to full intensity.

NOTE: The terminal accepts this command only during character-based attribute mode.

Filling a Rectangle with Attributes

Define character-based attributes
in a rectangle

ESC x I r c Ps

r = An ASCII character from Appendix F for the row (line) at which the sides of the block, extending from the cursor row, terminate.

c = An ASCII character from Appendix F for the column at which the top and bottom of the block, extending from the cursor column, terminate.

Ps = Any value of Ps on the previous page

This command removes the write-protected characteristic (attribute), as well as any other attribute, from the characters in the specified rectangle and assigns the designated attribute to the characters. The variables *r* and *c* define the row and column framing two sides of the block. The cursor anchors the corner opposite the junction of *r* and *c*.

NOTE: The terminal accepts this command only during character-based attribute mode. It does not accept this command while protect mode is enabled.

You cannot specify a value of *r* or *c* beyond line or column 96.

Information Area Attributes

Select the information area attribute

ESC _ Pa Ps

Pa Information Area

- 4 Status line
- 5 Status line message field
- 6 User message one
- 7 User message two

Ps = A variable from page 5.9

The information areas and the text areas have the same attribute type (selected with the command ESC F Pn or in set-up). Notice that the first position in an area contains an attribute character.

The following chart shows the default attributes of the various information areas:

Information Area	Attribute
Status line	Reverse
Status line message field	Normal
User message one	Normal
User message two	Normal

Status Line Attributes

Select the status line visual attribute(s)

SET-UP
DEFAULT Ps = 1
ESC [3 ; Ps v

Ps Attribute(s)

- 0 Normal
- 1 Reverse
- 2 Underline
- 3 Reverse underline

Write-Protected Character Attributes

SET-UP
DEFAULT Ps = 7
ESC . Ps

Select the attribute(s) of
write-protected characters

Ps	Attribute
6	Reverse
7	Half intensity
A	Normal
B	Blinking
C	Invisible
E	Underline
F	Reverse
G	Half intensity

Define the attributes of write-protected characters separately from those of normal text characters.

LINE APPEARANCE

The commands in this section let you display as few as 40 or as many as 132 character on a line.

Selecting the Number of Columns per Line

Select 80 columns per line

Select 132 columns per line

SET-UP
DEFAULT = 80
ESC | = 3 /
ESC . :
ESC | = 3 h
ESC . ;

These commands affect both the information lines and the data display lines. They do not clear the screen, but you should clear the message and function key label lines before changing the number of columns per line, then redisplay the lines programmed for the new column width.

If you change from 132 to 80 column mode, data in columns 81 through 132 remains in display memory. The cursor also remains in its current position, even if it is beyond the right margin of the display, and you can enter data in the undisplayed columns. But once you move the cursor into the display, you cannot go back into the undisplayed columns.

To retain an 80-column display, but be able to access the entire 132 columns, select 80/132-column mode in set-up, and scroll the display horizontally with CTRL-SHIFT-arrow keys. Read the applicable section in Chapter 1 for more information about terminal behavior during 80/132-column mode.

80-Column Economy Mode

Enable 80-column economy mode

Disable 80-column economy mode

DEFAULT = Off
ESC | = 24 h
ESC | = 24 /

CAUTION! This command can cause loss of data!

Eighty-column economy mode lets you configure the terminal for more pages of display memory (see Tables 6-2 and 6-3).

Enabling 80-column economy mode causes the following:

- * Both the data and information lines clear
- * The terminal locks into this mode and ignores the commands in the previous section to enable normal 80- or 132-column mode

Line Attributes

Define the line attribute(s)

DEFAULT Ps = @
ESC G Ps

Ps Attribute

- @ Single high/wide
- A Single high, double wide
- B Top half double high, single wide
- C Bottom half double high, single wide
- D Top half, double high/wide
- E Bottom half, double high/wide

CAUTION! Changing from single width to double width destroys all characters on the right half of the line.

Line attributes affect all current characters on the cursor line and any entered on that line after you change the attribute. Line attributes affect **only** the cursor line. The screen can contain lines with different attributes.

Lines of double-width characters can contain only half as many characters as a single-width line can. When you enable the double-wide attribute, the cursor moves to the screen's right margin if it is in a column that moves beyond the right margin.

Specify double-height lines in pairs (top line first) and send the same data to both. (The display may look strange until both lines are on the screen.)

Most printers print one character for each character position. For example, printing a page of double-high/wide characters could result in four printed characters for each display character.

TEST DISPLAYS

Self Test

Run the self test

ESC V

This command starts the self test described in Chapter 1. After you run the test, press SHIFT-CTRL-CLEAR SPACE, or send a clear command to clear the screen.

Monitor Mode

DEFAULT = Off

Monitor mode on

ESC U

Monitor mode off

ESC X

ESC u

Mode on The terminal displays commands (control and escape sequence characters) on the screen, instead of acting on them.

Mode off Terminal processes commands normally.

Chapter 1 shows a photo of a typical monitor mode display. Seeing command characters on the screen can help you debug a program. Appendix B shows how control characters appear on the screen in monitor mode.

If you want to display a control character without putting the terminal in monitor mode, send an escape character (or press LOC ESC) just before the control character.

NOTE: Press CTRL-SHIFT-1 (numeric keypad) to toggle monitor mode from the keyboard.

6 DISPLAY AND PAGE CONFIGURATION

Configuring Lines and Pages	6.1
Selecting the Number of Display Lines	6.4
Selecting the Number of Lines per Page	6.5
The Split Screen	6.7
Splitting Screen Without Clearing the Pages	6.7
Splitting Screen and Clearing the Pages	6.8
Sizing the Windows	6.8
Closing the Windows	6.8
Moving to Another Page or Windows	6.9
Page Movement Modes	6.10
Autopage Mode	6.10
Autoscroll Mode	6.11
Scrolling	6.12
Setting the Scrolling Rate	6.12
Defining the Scrolling Region	6.13
Locking One Line	6.14

6 DISPLAY AND PAGE CONFIGURATION

This chapter presents commands that control the following features:

- * Number of lines per display and per page of memory
- * Split screen
- * Scrolling

CONFIGURING LINES AND PAGES

The concepts in this section are fairly complex; you may need to study the tables carefully and then look over the line and page configuration commands that follow.

The terminal **automatically** divides display memory into pages. The number of pages that the terminal selects depends on these factors:

- * Number of lines per page
- * Current personality mode
- * Columns per line mode

In addition, the number of lines per page is affected by the number of display lines selected, since you cannot configure the display for more lines than the page has.

Tables 6-1 through 6-3 summarize these factors in the personality modes available in Revision A firmware.

Personality Mode Sets

Table 6-1

Set Number	Maximum Number of Pages of Memory	Personalities
One	Three	965, 955, WY-60, VPA2, DG200
Two	Seven	910/910+, 912/920, 925/905, 950, WY-50/50+, Hazeltine 1500, ADM 31

Line/Page Capabilities, Personality Set One
Table 6-2

Number of Defined Data Lines in Display	Possible Number of Lines Per Page	Possible Number of Pages When 80 or 132 Columns Per Line	Possible Number of Pages When Economy Mode 80 Columns Per Line
24	24	2	3
	48	1	1
	P. 1 = 24 lines; p. 2 = all remaining lines	P. 1 = 24 lns P. 2 = 24 lns	P. 1 = 24 lns P. 2 = 56 lns
25	25	1	3
	50	N/A	1
	P. 1 = 25 lines; p. 2 = all remaining lines	N/A	P. 1 = 25 lns P. 2 = 55 lns
42	42	1	1
43	43	1	1
48	48	1	1
49	49	1	1

No other combinations of lines per page and number of pages of memory are available in personality set one. Attempts to enable other combinations will cause the terminal to default to a 24-line display and page.

Line/Page Capabilities, Personality Set Two
Table 6-3

Number of Defined Data Lines in Display	Possible Number of Lines Per Page	Possible Number of Pages When 80 or 132 Columns Per Line	Possible Number of Pages When Economy Mode 80 Columns Per Line
24	24	4	7
	48	2	3
	96	1	1
	P. 1 = 24 lines; p. 2 = all remaining lines	P. 1 = 24 lns P. 2 = 79 lns	P. 1 = 24 lns P. 2 = 145 lns
25	25	4	7
	50	2	3
	100	1	1
	P. 1 = 25 lines; p. 2 = all remaining lines	P. 1 = 25 lns P. 2 = 78 lns	P. 1 = 25 lns P. 2 = 144 lns
42	42	2	4
	84	1	2
	168	N/A	1
	P. 1 = 42 lines; p. 2 = all remaining lines	P. 1 = 42 lns P. 2 = 61 lns	P. 1 = 42 lns P. 2 = 127 lns
43	43	2	3
	86	1	1
	P. 1 = 43 lines; p. 2 = all remaining lines	P. 1 = 43 lns P. 2 = 60 lns	P. 1 = 43 lns P. 2 = 126 lns

Line/Page Capabilities, Personality Set Two
Table 6-3 (continued)

Number of Defined Data Lines in Display	Possible Number of Lines Per Page	Possible Number of Pages When 80 or 132 Columns Per Line	Possible Number of Pages When Economy Mode 80 Columns Per Line
48	48	2	3
	96 P. 1 = 48 lines; p. 2 = all remaining lines	1 P. 1 = 48 lns P. 2 = 55 lns	1 P. 1 = 48 lns P. 2 = 121 lns
49	49	1	1
	98 P. 1 = 49 lines; p. 2 = all remaining lines	1 P. 1 = 49 lns P. 2 = 54 lns	1 P. 1 = 49 lns P. 2 = 120 lns

Selecting the Number of Display Lines

Select the number of display lines

SET-UP
DEFAULT Ps = 0
ESC [14 ; Ps v

Ps	Number of Lines
0	24
1	25
2	42
3	43
4	48
5	49

CAUTION! This command can cause loss of data! When you execute this command, the screen clears.

If you select 25, 43, or 49 lines, the bottom line overwrites the bottom information line.

Selecting the Number of Lines per Page

SET-UP
DEFAULT Ps = 1
ESC \ Ps

Define the number of lines per page of memory

Ps	Lines per Page
1	24
2	48
4	Same as number of display lines
5	Twice the number of display lines (where possible)
7	Page 1 same as number of display lines, page 2 contains all lines remaining in display memory

CAUTION! This command can cause loss of data!

When you execute this command, the terminal

- * Clears all pages of memory to space characters
- * Displays page one with the cursor at home position
- * Defines the display as one full screen
- * Redefines the scrolling region as the entire display

You cannot define the number of lines per page as less than the number of display lines.

The term **page** (i.e., document) refers to an amount of memory. Do not confuse number of lines in a page of memory with the number of lines on the **display** -- the amount of data that can be viewed on the screen at one time.

The figure on the following page shows the terminal's memory divided into pages, with a portion of one page displayed on the screen.

Terminal Display Memory

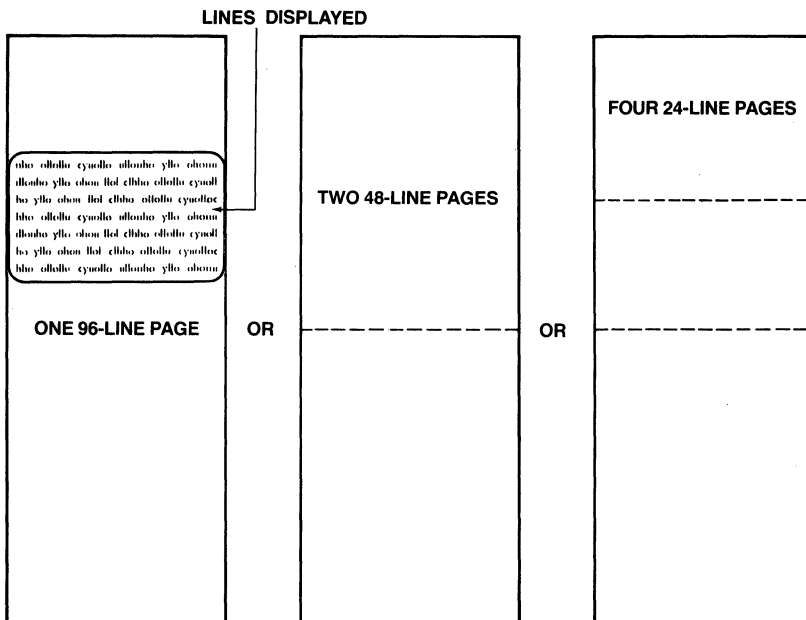

THE SPLIT SCREEN

You may split the screen into two horizontal windows. The top window shows the current (active) page; the page that appears in the bottom window depends on the total number of pages of memory. You can then move the cursor between windows (change the active page) and change the size of the windows.

While the screen is split, the commands to display another page of memory are still valid.

NOTE: Splitting the screen disables protect mode, and you cannot enable protect mode while the screen is split.

Splitting the Screen Without Clearing the Pages

Split the screen without clearing
(two pages of memory only)

DEFAULT Pn = 7
ESC \ A Pn

Split the screen without clearing
(one or more than two pages of memory)

ESC \ C Pn

Pn = a character from the cursor coordinate table in Appendix F representing the line number on the display where the lower window starts

One page of memory The top line of the upper window is line one of the page. The top line of the lower window is line Pn of the page.

Multiple pages of memory The top line of the upper window is line one of the current page. The top line of the lower window is line one of the next sequential page. If the upper window contains the last configured page, the lower window contains page zero.

When you split the screen, the cursor moves to home position.

Splitting the Screen and Clearing the Pages

Split the screen and clear both pages
(two pages of memory only)

DEFAULT P_n = 7
ESC \ D P_n

Split the screen and clear both pages
(one or more than two pages of memory)

ESC \ E P_n

P_n = a character from the cursor coordinate table in Appendix F representing the line number on the display where the lower window starts

This command has the same effects as the previous command to split the screen without clearing the pages, except that both affected pages are cleared to replacement characters.

Sizing the Windows

Lower the horizontal split
Raise the horizontal split

ESC \ P
ESC \ R

Each time you send one of these commands to the terminal, the windows increase/decrease by one line. Data that scrolls off the screen remains in memory.

This command is ignored if the screen is not in a split screen mode.

Closing the Windows

Return the active window to full display size
Return the active window to full display size
and clear the pages

ESC \ @
ESC \ 0

Pages not cleared The current page is displayed on the full screen. The page in the inactive window is saved in display memory.

Pages cleared Pages in both windows are cleared to replacement characters. The active page is displayed on the full screen, with the cursor in home position.

Moving to Another Page or Window

Activate the upper window

Activate the lower window

Display the previous page or activate the other window

Display the next page or activate the other window

Display page Pn

DEFAULT Pn = 0

ESC \ H

ESC \ I

ESC J

ESC K

ESC [1 ; Pn]

Pn = A decimal value from 0 through 6

NOTE: The terminal can have up to seven pages of memory. The page numbers, however, are 0 through 6.

These commands let you move the cursor between windows (or pages). The command to display page Pn lets you move to any page in memory regardless of the page currently displayed. The status of autopage mode is irrelevant.

If you have already displayed the next or previous page, or when you are working with a split screen, the cursor returns to its last location there after a next or previous page command. Otherwise, the cursor goes to the first unprotected (home) position. See the figure below.

Cursor Movement Between Adjacent Pages

oho ollolu cyuello allonho ylio ohom
allonho ylio ohom lol ellho ollollu cyuall
ho ylio ohom lol ellho ollollu cyuelloc
lho ollollu cyuello allonho ylio ohom
allonho ylio ohom lol ellho ollollu cyuall
ho ylio ohom lol ellho ollollu cyuelloc
lho ollollu cyuello allonho ylio ohom

PAGE 1

oho ollollu cyuello allonho ylio ohom
allonho ylio ohom lol ellho ollollu cyuall
ho ylio ohom lol ellho ollollu cyuelloc
lho ollollu cyuello allonho ylio ohom
allonho ylio ohom lol ellho ollollu cyuall
ho ylio ohom lol ellho ollollu cyuelloc
lho ollollu cyuello allonho ylio ohom

PAGE 2

oho ollollu cyuello allonho ylio ohom
allonho ylio ohom lol ellho ollollu cyuall
ho ylio ohom lol ellho ollollu cyuelloc
lho ollollu cyuello allonho ylio ohom
allonho ylio ohom lol ellho ollollu cyuall
ho ylio ohom lol ellho ollollu cyuelloc
lho ollollu cyuello allonho ylio ohom

PAGE 1

PAGE MOVEMENT MODES

Autopage Mode

Autopage mode on
Autopage mode off

DEFAULT = Off
ESC v
ESC w

Autopage on A new page in the terminal's memory moves onto the screen when the terminal receives a command to move the cursor beyond the current page.

A line feed or reverse line feed command moves the cursor to the first or last line of an adjoining page (while remaining in the same column position.)

A cursor right, cursor left, or cursor addressing command displays the adjoining page when the cursor reaches the beginning or end of a page, as shown in the figure below. When the cursor reaches the end of the last page, it returns to the beginning of the first page.

Data on a page that moves off the screen is not cleared. When you return to that page, your data reappears.

Autopage off When autopage mode is disabled, autoscroll mode, described in the next section, determines the effects of cursor movement on page and data display.

Cursor Movement in Autopage Mode

lo ohon llol ellho ollollu cyuolle ul
ollollu cyuolle ullonho ylllo ohon llol e
lu cyuolle ullonho ylllo ohon llol ellh
lo ohon llol ellho ollollu cyuolle ul
ollollu cyuolle ullonho ylllo ohon llol e
lu cyuolle ullonho ylllo ohon llol ellh
lo ohon llol ellho ollollu cyuolle ul

lho ollollu cyuolle ullonho ylllo ohon
ullonho ylllo ohon llol ellho ollollu cyuoll
ho ylllo ohon llol ellho ollollu cyuoll
lho ollollu cyuolle ullonho ylllo ohon
ullonho ylllo ohon llol ellho ollollu cyuoll
ho ylllo ohon llol ellho ollollu cyuoll
lho ollollu cyuolle ullonho ylllo ohon

PAGE 1
BEFORE

lho ollollu cyuolle ullonho ylllo ohon
ullonho ylllo ohon llol ellho ollollu cyuoll
ho ylllo ohon llol ellho ollollu cyuoll
lho ollollu cyuolle ullonho ylllo ohon
ullonho ylllo ohon llol ellho ollollu cyuoll
ho ylllo ohon llol ellho ollollu cyuoll
lho ollollu cyuolle ullonho ylllo ohon

lu cyuolle ullonho ylllo ohon llol ellh
lo ohon llol ellho ollollu cyuolle ul
ollollu cyuolle ullonho ylllo ohon llol e
lu cyuolle ullonho ylllo ohon llol ellh
lo ohon llol ellho ollollu cyuolle ul
ollollu cyuolle ullonho ylllo ohon llol e
lu cyuolle ullonho ylllo ohon llol ellh

PAGE 2
AFTER

Autoscroll Mode

Autoscroll mode on
Autoscroll mode off

DEFAULT = On
ESC [= 19 h
ESC [= 19 l

Autoscroll on If autopage and protect modes are turned off, data scrolls up (or down) one line when the cursor moves past the last (or first) line of the page. The line that scrolls off the screen is lost and a new line of replacement characters appears at the other end of the display.

CAUTION! This mode can cause loss of data!

Table 6-4 lists the keys and commands that can cause loss of data, and the figure below illustrates data loss from scrolling. *To prevent loss of data, enable protect or autopage mode.*

Data Loss Due to Scrolling
Table 6-4

Key	Command	Function
LINE FEED SHIFT-DOWN	CTRL J	Line feed
SHIFT-UP	ESC j	Reverse line feed
RIGHT	CTRL L	Cursor right
Alphanumeric --		Data entry from computer or keyboard

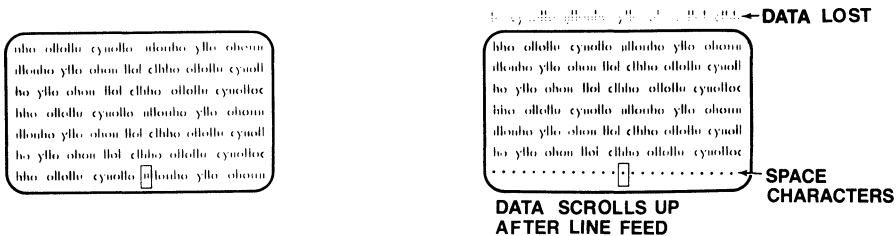

Autoscroll off The cursor does not move beyond the top or bottom of the page.

SCROLLING

Scrolling is the movement of data on the screen. There are two types of scrolling:

- * The flow of data received from the host onto the screen
- * The movement of displayed data lines as you move the cursor or enter data from the keyboard. If your defined page size is greater than the number of defined display lines, data entry or cursor movement can cause data lines to scroll up or down into other areas of the page.

Setting the Scrolling Rate

Select normal smooth scroll (4 lines/second)	ESC 8
Select jump scroll	ESC 9
Set the scrolling rate	ESC . Ps

Ps Rate (Lines Per Second)

<	Smooth scroll at 1
=	Smooth scroll at 2
>	Smooth scroll at 4
?	Smooth scroll at 8
@	Jump scroll

Set the scrolling rate	ESC [6 ; Ps v
------------------------	----------------

Ps Rate (Lines Per Second)

0	Jump
1	Normal (4)
2	Slow (2)
3	Fast (8)
4	Very slow (1)

Jump scrolling displays data at the rate it is received.

Defining the Scrolling Region

Define the scrolling region

ESC [Pt ; Pb r

Pt = The decimal number of the top line in the scrolling region

Pb = The decimal number of the bottom line in the scrolling region

This command fixes certain lines on the screen, while permitting the display to scroll through a section of the screen. You can design pages, such as a business form, with a defined head and foot area and a center area through which data can scroll.

Count Pt and Pb from the screen's top line (line number one), in single-height lines, even when you have configured the display for double-height lines. Values range from 1 to 24.

The area outside the defined scrolling region is called the **memory-locked area** (shown below). Data in that area cannot scroll, and you cannot move the cursor into that area to manipulate data.

Defining a scrolling region moves the cursor to home position.

Shown below is a screen containing all double-height lines, with the defined scrolling region starting at line five and ending at line 18 (Pt = 5, Pb = 18).

Scrolling Region of Double-Height Lines

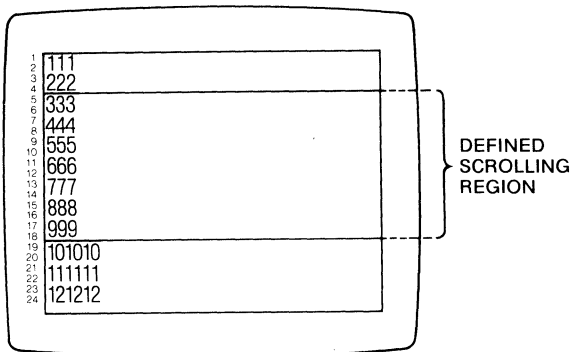

Locking One Line

Enable line lock

ESC ! 1

ESC . H

Disable line lock

ESC ! 2

ESC . I

You can lock selected lines on the screen with this command, so they remain fixed regardless of the scrolling of the rest of the display.

To lock a line, place the cursor on the desired line and send the command. You may lock all but one of the displayed lines.

The command to disable line lock unlocks all locked lines.

7 EDITING AND CURSOR MOVEMENT

Editing Modes	7.1
Write Protect and Protect Modes	7.1
Creating a Protected Form	7.3
Editing Key Mode	7.5
Down Key Mode	7.5
Autowrap Mode	7.5
New Line Mode	7.6
Editing Mode	7.6
Insert and Replace Mode	7.7
The Replacement Character	7.7
Editing Data	7.8
Inserting Replacement Characters	7.8
Inserting Null Characters	7.9
Repeating a Character	7.9
Deleting Data	7.9
Clearing a Field	7.11
Erasing a Column	7.12
Erasing Unprotected Data	7.13
Erasing a Rectangle	7.14
Cursor Control	7.15
Cursor Movement	7.15
Line Feed and Reverse Line Feed	7.16
Addressing the Cursor	7.18
Reading the Cursor	7.19
Addressing the Cursor in Decimal Units	7.19
Reading the Cursor in Decimal Units	7.19
Tabulation	7.20
Setting Tab Stops	7.20
Clearing Tab Stops	7.21
Moving the Cursor to a Tab Stop	7.21

7 EDITING AND CURSOR MOVEMENT

This chapter details the commands that control editing and cursor movement.

EDITING MODES

Editing modes affect the action of many editing commands, some of which can cause loss of data. If you are unsure about the setting of a mode or the effect of a command, experiment on data you don't mind losing.

Write Protect and Protect Modes

Enable write protect mode	ESC)
Disable write protect mode	ESC (
Enable protect mode	ESC &
Disable protect mode	ESC '

While write protect mode is enabled, any data then entered is *write protected*. When you later enable protect mode, only certain commands can edit and transmit write-protected characters.

Protect mode guards all write-protected characters on the screen. Cursor position is irrelevant when you enable protect mode.

NOTE: You cannot enable protect mode when the terminal screen is split.

Table 7-1 describes the effects of protect mode. The procedure for entering write-protected data and enabling protect mode follows.

Effects of Protect Mode

Table 7-1

Function	Effect
Data entry	The cursor skips over protected fields during data entry.
Cursor movement	Cursor movement commands cannot cause protected or <i>unprotected</i> data to scroll off the screen. The cursor skips over protected fields in response to cursor movement commands.
Tabulation	The first unprotected position after a protected field becomes a field tab stop. Sending a tab command moves the cursor to the first field tab stop following a protected field.
Editing	Most editing commands affect only unprotected data. Only some clear commands (see the section titled "Clearing Data") can affect protected data.
Data transmission	Only specific commands transmit protected characters.

Creating a Protected Form

Using write protect and protect modes, you can create forms with permanent (protected) headings and blank areas for an operator to fill in later. Protecting the headings keeps them from being accidentally deleted or changed.

The photo below shows a typical form with protected areas.

The image shows a terminal window with a sales order form. At the top, there are three fields: 'Sales Order', 'Sales Order Form', and 'Date'. Below this, there are two columns of information for 'Bill to' and 'Ship to', each with fields for 'Company Name', 'Address', 'City, State', and 'Zip Code'. The main part of the form is a table with five columns: 'Item', 'Qty', 'Part Number and Description', 'Unit Price', and 'Total Cost'. The table is currently empty. At the bottom, there are several fields: 'Terms Net', 'Purchase Order Number', 'Subtotal', 'F.O.B.', 'Sales Contact', 'Tax', 'Shipper', 'Other Comments', and 'TOTAL'.

Creating protected data, such as a form, takes two steps:

- * Turn on *write protect* mode and enter the data you want to protect.
- * Turn on *protect mode* to guard the write-protected data.

Follow the steps below to enter protected data:

1. Position the cursor where you want to enter the first protected character.

2. Enter

ESC)

to enable write protect mode.

3. Enter the information you want to protect.

NOTE: Bracketing existing data with the commands to enable and disable write protect mode does not write protect the field. To write protect existing data, you must enable write protect mode, then retype the desired characters.

4. Enter

ESC (

to turn off write protect mode.

5. After entering all data you want to protect and disabling write protect mode, turn on protect mode. All write-protected areas are now protected.

Editing Key Mode

SET-UP
DEFAULT = Duplex
ESC k
ESC l

Enable local editing key mode
Enable duplex editing key mode

Duplex mode The communication mode determines the destination of all key codes.

Local mode Even in a conversational communication mode, codes from the following keys act locally (go to the screen only):

HOME	RETURN	LINE INS	CHAR INS
DOWN	PRINT	LINE DEL	CHAR DEL
UP	SEND	LINE ERASE	PAGE ERASE
LEFT	CE	LINE FEED	CLEAR SPACE
RIGHT	PAGE	TAB (BOTH)	

NOTE: The effects of this command do not completely correspond to the effects of redirecting editing key codes in set-up.

Down Key Mode

DEFAULT = CTRL V
ESC [= 9 l
ESC [= 9 h

Down key sends CTRL V
Down key sends CTRL J

See the section about the line feed command for information about the effects of the CTRL J code.

Autowrap Mode

SET-UP
DEFAULT = On
ESC [= 7 h
ESC [= 7 l

Autowrap mode on
Autowrap mode off

Autowrap on The cursor wraps from the end of one line to the start of the next line during data entry. Autowrap mode does not change the effect of the cursor movement commands.

Autowrap off Each character entered after the cursor reaches the line's last unprotected position overwrites the previous one.

New Line Mode

SET-UP
DEFAULT = Off
ESC [= 6 h
ESC [= 6 l

New line mode on
New line mode off

New line on A carriage return code (CTRL M), from the host or the keyboard, moves the cursor down one line and then to the start of the new line (LF/CR), just as a new line code (CTRL _) does.

New line off Carriage return code causes only a carriage return.

NOTE: When protect mode is on, a line feed followed by a carriage return can move the cursor differently than a carriage return followed by a line feed. A line feed command can move the cursor into a protected field; a carriage return cannot. The figure below shows the difference.

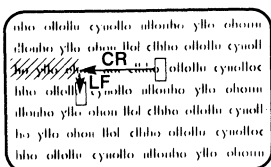

CR/LF

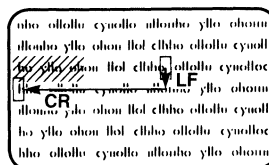

LF/CR

Editing Mode

DEFAULT = Line
ESC N
ESC O

Enable page edit mode
Enable line edit mode

Line edit mode When you insert or delete characters, existing data moves forward or backward only on the current line. Data pushed beyond the end of the line is lost. The terminal automatically enables line edit mode when you turn on protect mode.

Page edit mode Existing data wraps around from line to line. Data moves to the end of the page before it is lost. When protect mode is on, the terminal ignores the command to enable page edit mode.

Insert and Replace Mode

DEFAULT = Replace

Enable insert mode

ESC q

Enable replace mode

ESC r

Insert mode Existing data is pushed aside (to the right) by new data. Data pushed to the end of the line or page (depending on edit mode, below) is lost.

Replace mode New data replaces (writes over) existing data.

The Replacement Character

DEFAULT = Space

Load a replacement character

ESC e Ps

Ps = Any ASCII character

Some editing commands replace data with a predefined *replacement* character. You can reprogram this character as any ASCII character. This terminal capability lets you replace data with characters such as an underline or asterisk.

EDITING DATA

This section explains the commands to insert, delete, erase, and clear characters.

Inserting Replacement Characters

Insert a replacement character at the cursor position	ESC Q
Insert Pn replacement characters, starting at the cursor position	ESC [Pn @
Insert a line of replacement characters on the current line	ESC E
Insert Pn lines of replacement characters, starting at the current line	ESC [Pn L

Pn = A decimal value

Table 7-2 describes the effect of protect mode on insert commands.

Effect of Protect Mode on Insert Commands

Table 7-2

Command	Protect Mode	Effect
Insert character (ESC Q) or characters (ESC [Pn @)	Off	Enters replacement character(s) at the cursor position and moves existing characters right. Data pushed past the end of the line or page is lost.
	On	Only unprotected characters in the current field move. Characters reaching the first protected position or the end of the line (whichever comes first) are lost.
Insert line (ESC E) or lines (ESC [Pn L)	Off	Inserts line(s) of replacement characters starting at the current line; moves all following lines down. Cursor moves to column one of the new line. Lines pushed off the screen are lost.
	On	No action.

Inserting Null Characters

Insert a column of null characters at the cursor position **ESC x M**

This command inserts a column of null characters from top to bottom of the page. Characters to the right of the column on every line are shifted one position to the right.

CAUTION! This command can cause loss of data! The last character on each line or before a protected field is pushed "off the edge" and lost.

Repeating a Character

Repeat the next character Pn times **ESC [Pn b**

Pn = A decimal character

This command writes the cursor character for a specified number of times, extending to the end of the line or page. When a protected field is encountered, the cursor skips over it and continues writing. Characters are pushed ahead of the cursor or overwritten, depending on the status of insert/replace mode.

Deleting Data

Delete a character	ESC W
Delete Pn characters	ESC [Pn P
Delete the cursor column	ESC x J
Delete the current line	ESC R
Delete Pn lines	ESC [Pn M

Pn = A decimal value

Deleting *removes* unprotected data only, starting at the cursor position, and pulls the remaining characters back to the left. Replacement characters appear at the end of the line or page.

The following figure shows how data is deleted in a line, and Table 7-3 describes the effects of protect mode on delete commands.

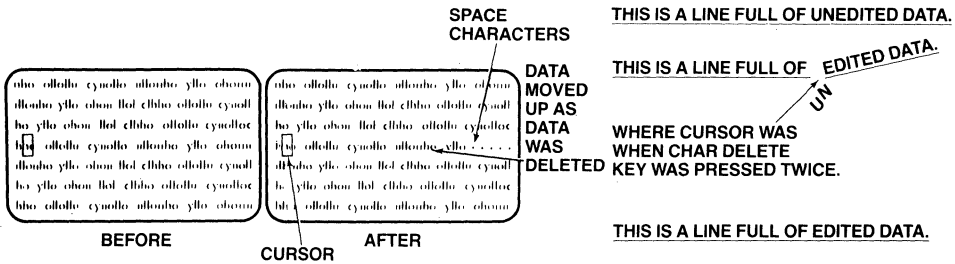

Effect of Protect Mode on Delete Commands
Table 7-3

Command	Protect Mode	Effect
Delete a character (ESC W) or characters (ESC [Pn P)	Off	Deletes character(s) starting at the cursor; pulls the following characters left.
	On	Same as protect off except only unprotected characters are deleted.
Delete a line (ESC R) or lines (ESC [Pn M)	Off	Deletes line(s) starting at the cursor line and moves remaining lines up. Moves the cursor back to the first position.
	On	No action.

Clearing a Field

Clear the current tab field and replace with replacement characters	CTRL X
Clear unprotected characters in the page and replace with write protected space characters (disable protect mode)	ESC ,
Clear unprotected characters in the page and replace with replacement characters	ESC ; CTRL Z
Clear unprotected characters in the page and replace with null characters	ESC :
Clear all characters in the page and replace with replacement characters (disable protect and write protect modes)	ESC +
Clear all characters in the page and replace with null characters (disable protect and write protect modes)	ESC *
Clear unprotected characters in the page and replace with specified character	ESC <space> Pc

Pc = Any ASCII character

Clearing *replaces* data with space, replacement, or null characters. Unlike erasing and deleting, clear commands (except CTRL X) do not relate to the cursor position; what you clear depends only on the command you give.

All clear commands except CTRL X move the cursor to home or the first unprotected position.

Enabling protect mode affects the clear field command, CTRL X:

Protect mode off CTRL X clears all characters in the cursor tab field (or the line, if no tab stops are set) to replacement characters. The cursor moves to the beginning of the field (or line).

Protect mode on CTRL X clears the unprotected characters in the cursor field to replacement characters. The cursor moves to the beginning of that field.

Erasing a Column

Erase a column of unprotected characters at the cursor position and replace with write-protected replacement characters ESC x O

Erase a column of unprotected characters at the cursor position and replace with null characters ESC x K

Erase a column of unprotected characters at the cursor position and replace with specified characters ESC x N Ps

Ps = Any ASCII character

The erased column extends from top to bottom of the display.

Erasing Unprotected Data

Erase characters from the cursor to end of line; replace with replacement characters **ESC T**

Erase specified characters in the current line, replace with replacement characters **ESC [Ps K**

Erase characters from the cursor to protected field or end of line; replace with null characters **ESC t**

Erase characters from the cursor to the end of the line and replace with null characters **ESC x L**

Erase characters from the cursor to end of page; replace with replacement characters **ESC Y**

Erase specified character in the page, replace with replacement characters **ESC [Ps J**

Erase characters from the cursor to end of screen; replace with null characters **ESC y**

Ps Amount Erased

- 0 From cursor to end of line/field or page
- 1 Start of line/field or home position to cursor
- 2 Entire line/field or page

These commands replace only unprotected characters with replacement or null characters. The cursor and existing data do not move.

NOTE: Write protected characters are not protected until you enable protect mode. To avoid losing write protected data, enable protect mode before sending an erase command.

Erasing a Rectangle

Erase the unprotected characters in a rectangle and replace them with character *Ps* ESC x F r c Ps

Erase all characters in a rectangle and replace them with character *Ps* ESC x H r c Ps

r = An ASCII character from Appendix F for the row (line) at which the sides of the block, extending from the cursor row, terminate.

c = An ASCII character from Appendix F for the column at which the top and bottom of the block, extending from the cursor column, terminate.

Ps = Any ASCII character.

The variables *r* and *c* define the row and column framing two sides of the block. The cursor anchors the corner opposite the junction of *r* and *c*.

CAUTION! The command to erase all characters can cause loss of data! This command is effective even on protected characters.

The area erased with these commands may extend above or below the cursor, and to the right or left. It may extend on a page or a defined scrolling region beyond the edge of the display. You cannot specify a value of *r* or *c* beyond line or column 96.

Chapter 8 contains commands to draw a rectangle on the screen.

CURSOR CONTROL

Many cursor movements are affected by protect and autoscroll modes. The tables that follow each set of commands explain how they are affected.

Cursor Movement

Move the cursor up	CTRL K ESC [Pn A
Move the cursor down	CTRL V ESC [Pn B
Move the cursor right	CTRL L ESC [Pn C
Move the cursor left (back space)	CTRL H ESC [Pn D
Move the cursor to home position	CTRL ^
Carriage return	CTRL M

Pn = A decimal value

When the cursor reaches the top or bottom of the page, it does not move any further.

The cursor home command moves the cursor to the first unprotected screen position (usually home position, row 1 and column 1). It has no effect if the cursor is already there.

During protect mode, right and left commands skip the cursor over a protected field, but up and down commands move the cursor into the field.

When autowrap mode is disabled, the cursor right and cursor left commands do not wrap the cursor from its current line to the next or previous line.

The cursor right command can cause data to scroll off the screen under certain circumstances, as shown in Table 7-4.

Effect of the Cursor Right Command

Table 7-4

Auto-wrap Mode	Auto-scroll Mode	Protect Mode	Effect
On	On	Off	If the cursor is on the last column of the last line, data scrolls up one line. The first line is lost, and a new bottom line of replacement characters appears.
On	On/Off	On	If the cursor is on the last unprotected position, it wraps around to the first unprotected position.
Off	On/Off	On/Off	If the cursor is on the last unprotected position, it stops.

Line Feed and Reverse Line Feed

Line feed	CTRL J
Reverse line feed	ESC j
New line (line feed/carriage return)	CTRL _
Move the cursor down Pn lines	ESC [Pn S
Move the cursor up Pn lines	ESC [Pn T

Pn = A decimal figure for the desired number of lines

CAUTION! These commands can cause loss of data!

These commands move the cursor up or down within the page. When the cursor reaches the top or bottom of the page or defined scrolling region, the lines scroll if protect mode is off. The lines that scroll off the screen are lost, and new lines of replacement characters appear at the other end of the screen.

Tables 7-5 and 7-6 summarize how autoscroll and protect modes affect vertical cursor wrap.

Cursor Movement After a Line Feed Command

Table 7-5

Auto-scroll Mode	Protect Mode	Effect
On	On	If the cursor is at the bottom of the page, it wraps around to the top line.
	Off	If the cursor is at the bottom of the page, the display scrolls up one line. The top line is lost, and a new bottom line of replacement characters appears.
Off	On/Off	When the cursor reaches the last line, it wraps around to the first line.

Cursor Movement After a Reverse Line Feed Command

Table 7-6

Modes		Effect
Auto-scroll	Protect	
On	On	When the cursor reaches the top line, it does not move any farther.
	Off	When the cursor reaches the top line, data scrolls down. A new top line filled with replacement characters appears, and the old bottom line is lost.
Off	On/Off	When the cursor reaches the first line of the page, it does not move.

Addressing the Cursor

Address (send) cursor to row and columns 1 through 80	ESC = r c
Address (send) cursor to row and columns 81 through 132	ESC = r ~ c
Address (send) cursor to page, row, and columns 1 through 80	ESC - p r c
Address (send) cursor to page, row, and columns 81 through 132	ESC - p r ~ c

r = An ASCII character from the cursor coordinate table in Appendix F for the row (line).

c = An ASCII character from Appendix F for the columns. To calculate the value of **c** for columns 81-132, subtract 80 from the column number and find the corresponding ASCII character.

p	Page
0	1
1	2
2	3
3	4
4	5
5	6
6	7

This command lets you move the cursor to a specified screen location. If your computer inserts nulls between characters, the terminal response to this command is unpredictable.

For example, ESC = (Q sends the cursor to row 9, column 50; and ESC = (~ Q sends the cursor to row 9, column 130.

Reading the Cursor

Read cursor row and column position	ESC ?
Read cursor page, row, column position	ESC /

The terminal responds to these commands with characters from the cursor coordinate table in Appendix F representing the row and column, as shown in the cursor addressing examples above. A carriage return character terminates the report.

If you send the command ESC /, the terminal sends a zero for page 0, a one for page 1, and so forth.

Addressing the Cursor in Decimal Units

Address the cursor to line and column of the current page in decimal units	ESC [Pl ; Pc H ESC [Pl ; Pc f
---	------------------------------------

Pl = A decimal value (one or two digits) for the line

Pc = A decimal value (one, two, or three digits) for the column

If you address the cursor to a nonexistent area, it moves as far as logical to the right and down.

If you enter no variables, the cursor moves to home position.

Reading the Cursor in Decimal Units

Read the cursor row and column in decimal units	ESC [6 n
Read the cursor page, row, and, column in decimal units	ESC [? 6 n

The terminal responds in the format

ESC [Pl ; Pc R.
or ESC [Pp ; Pl ; Pc R

with Pp and Pl in decimal units.

TABULATION

The terminal has two types of tab stops:

- * Typewriter (recognized only when protect mode is off)
- * Field (recognized only when protect mode is on)

Setting Tab Stops

Set field (protect mode on) or typewriter (protect mode off) tab stops ESC 1

CAUTION! This command can destroy data during protect mode.

Field tab stops can be set in two ways:

- * Enabling protect mode automatically sets field tab stops at the first unprotected position after each protected field.
- * Sending ESC 1 while protect mode is enabled creates a column of protected space characters at the cursor position, *destroying the characters that occupy that column*. The column extends down from the cursor line until it encounters a protected character. The first unprotected position *after* the protected replacement character in each line becomes a field tab stop, as shown in the figure on the following page. The cursor moves from its previous position, now a protected replacement character, to the new field tab stop.

After protect mode is disabled, the protected column remains as a column of write-protected replacement characters.

When protect mode is off, sending ESC 1 creates a tab stop in every line *at the current column position*.

Be sure you enter a number one in the command. A lowercase *l* turns on duplex edit mode.

Setting Field Tab Stops

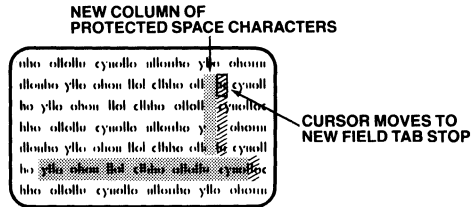
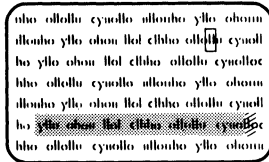

■ PROTECTED CHARACTERS

▨ FIELD TAB STOPS

Clearing Tab Stops

Clear typewriter tab stop at cursor location ESC 2

Clear all typewriter tab stops ESC 3

The cursor position is irrelevant when you clear all typewriter tab stops.

Turning protect mode off automatically clears field tab stops. Turning it on again automatically resets them.

Moving the Cursor to a Tab Stop

Move cursor forward to next typewriter or field tab stop CTRL I

Move cursor forward to next field tab stop ESC i

Move cursor backward to previous typewriter or field tab stop ESC I

Table 7-7 describes the effect of protect mode on tabulation commands.

Effect of Protect Mode on Tabulation Commands

Table 7-7

Command	Protect Mode	Effect
Tab forward (CTRL I)	Off	Moves the cursor to the next typewriter tab stop. If no more tab stops exist, the cursor does not move.
	On	Moves the cursor to the first position in the next unprotected field (next field tab stop). If the screen has no more unprotected fields, the cursor returns to the first unprotected position.
Tab backward (ESC I)	Off	Moves the cursor back to the previous typewriter tab stop. If the cursor is already on the first tab position on the line, or if no other tabs stops exist, the cursor moves to the first column of the line.
	On	Moves the cursor back to the first position in the current or previous unprotected field. If the screen has no previous unprotected positions, the cursor does not move.

8 CHARACTER SETS

Selecting a Character Set	8.1
Selecting an International Character Set	8.4
Loading the Font Banks	8.5
Automatic Font Loading	8.6
Special Graphics Mode	8.6
Designating the Primary and Secondary Character Sets	8.7
Displaying a Character Set	8.7
Displaying One Character From the Secondary Set	8.7
Designing Custom Characters	8.8
Anatomy of a Character Cell	8.8
Creating a Soft Character	8.12
Block Graphics	8.15
Creating a Measured Block	8.15
Creating a Positioned Block	8.16

8 CHARACTER SETS

The 965 can display an extensive range of alphanumeric, special symbol, and graphics characters. You may also design and download custom characters.

SELECTING A CHARACTER SET

The 965 Rev. A firmware has seven character sets available. The default character sets are native mode ASCII and multinational sets, in both normal and small fonts.

Changing the sets from the default group can be a fairly complex process. Here is a summary of the steps that would be involved in selecting nondefault values all the way. In most cases, you'd go with the default values at some point, and the process wouldn't be so long.

1. Decide which set(s) you want to load in place of the default set(s).
2. Change the native mode character set from U.S. ASCII to one of the other national character sets before loading the font banks.
3. Load the desired character set(s) into the font bank(s) (character generator).
4. If desired, load custom (soft) characters into one of the sets in the font banks.
5. Select a primary and a secondary character set from the sets in the font banks.
6. Display the primary or secondary character set.

The following pages show the character sets as displayed on screen. Note that native mode control characters (00h to 1Fh) are replaced by 32 special graphics characters. Appendix B shows control and display characters with their code equivalents.

Wyse 60 7-Bit Characters

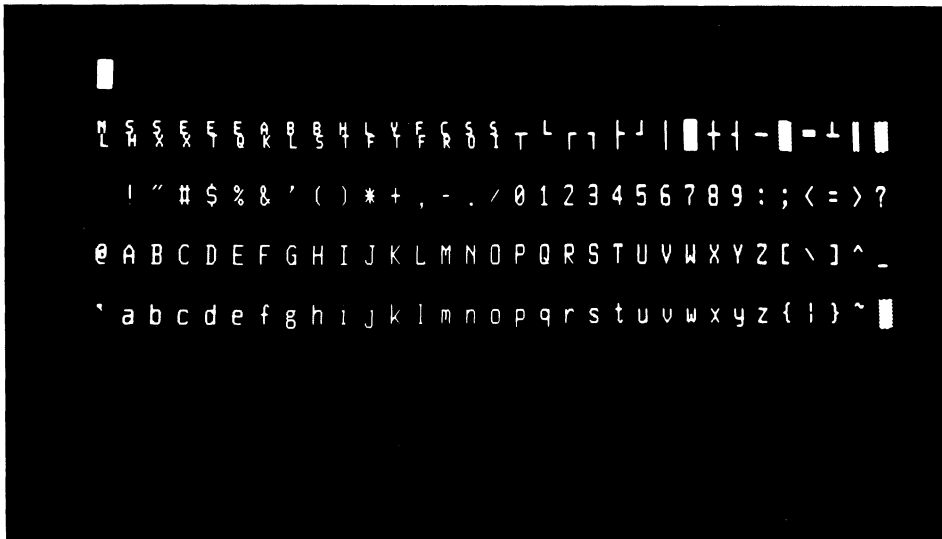

Wyse 60 Graphics Characters

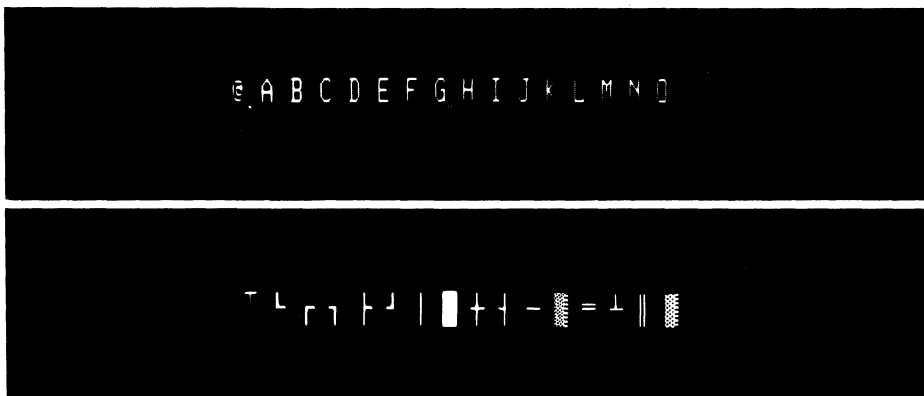

NOTE: The figure above shows the graphics characters in line with the corresponding keys you press to produce them.

The sections below present the commands to select, load, and display character sets. The command to create and load a soft character is presented in a separate, following section.

NOTE: When you change terminal personality mode or the number of display lines, the character set changes to match the new configuration, unless you disable auto font load.

Selecting an International Character Set

SET-UP
DEFAULT Ps = 0
ESC [9 ; Ps v

Select an international character set

Ps	Character Set
0	U.S. ASCII
1	U.K.
2	French
3	German
4	Spanish
5	Finnish
6	Norwegian
7	Italian
8	Danish
9	Swiss German
10	Swiss French
11	Swedish
12	French Canadian

This command defines the native mode character set (Ps = @) in the following command. When you want to select an international character set, send this command first, before loading the font banks and designating and selecting the primary and secondary character sets.

You can order keycaps that correspond to the character sets. The keyboard layouts in Appendix E show some of the character sets; consult your TeleVideo dealer for up-to-date information about the availability of international keycap sets.

Loading the Font Banks

Load a character set into a font bank
Clear a font bank

DEFAULT Pb = 0; Ps = @
ESC x @ Pb Ps
ESC x ? Pb

Pb = A decimal number from 0 to 3 that selects the corresponding font bank

Ps Character Set

@	965 native mode
A	965 multinational
B	Wyse 60 native mode
C	Wyse 16-character graphics
D	IBM 7-bit
E	IBM 8-bit
F	Reserved
G	Reserved
H	Soft characters
'	Small 965
a	Small 965 multinational
b	Small Wyse 60 native mode
c	Small IBM 7-bit
d	Small IBM 8-bit

NOTE: If you clear the font bank containing the currently displayed character set, the screen goes blank. Data reappears in the redesignated character set when you reload the font bank. When you change the terminal personality, the character set changes to the set appropriate for the new personality, unless you have disabled auto font load.

If you intend to create soft characters, load the soft character set (Ps = H) into a font bank and then load the soft characters into the set.

The "small" character sets are intended for display when the screen is configured for 42 to 49 lines. See the section "Anatomy of a Character Cell," later in this chapter, for a description of standard and small characters.

The terminal sends ACK after executing these commands.

Default font bank loading is:

Bank	Ps	Character Set
0	@	965 native mode
1	A	965 multinational
2	'	Small 965
3	a	Small 965 multinational

Automatic Font Loading

Disable auto font loading

Enable auto font loading

SET-UP

DEFAULT = Enabled

ESC [= 29 /

ESC [= 29 h

When you enable auto font mode, the terminal automatically loads and displays the correct character set for the selected terminal personality mode and number of display lines.

NOTE: Switching between personalities does not reset auto font loading mode.

Special Graphics Characters

Enable special graphics mode

Disable special graphics mode

DEFAULT = Disabled

ESC \$

ESC %

Graphics mode on The terminal converts 7-bit alphanumeric characters to 32 write-protected special graphics characters. The first 16 are compatible with the 950 terminal graphics characters. The photo at the top of page 8.2 shows the 32 graphics characters and the keys you press to produce them. (The last character is a space, which occupies a position but is not visible.)

Graphics characters are automatically write protected. Protect mode and visual attribute commands affect them as they would any other write-protected character.

Designating the Primary and Secondary Character Sets

DEFAULT Pb = 0/1

Define the primary character set

ESC x B Pb

Define the secondary character set

ESC x C Pb

Pb = The number (0 to 3) of the font bank containing the character set designated as primary or secondary

This command defines two of the four character sets loaded into the font banks as primary and secondary character sets. The terminal displays the primary character set unless the secondary set is chosen with the command below.

Displaying a Character Set

DEFAULT = Primary

Display the primary character set

ESC x D

Display the secondary character set

ESC x E

This command determines the character set actually displayed when you enter data.

Displaying One Character From the Secondary Set

Display one character from the secondary character set

CTRL U Ps

Ps = Any character from ! (21h) to ~ (7Eh)

Once you have loaded and designated the primary and secondary character sets, you can display characters from the secondary set one at a time. When you send CTRL U, followed by a character from the primary set, the screen displays the character from the secondary set that occupies the corresponding position in the font bank.

NOTE: The multinational character sets are contained in the character generator at positions A1h to FEh. When you enable 8-bit data word mode, you can send these characters from the computer with that code range. (The characters at A0h and FFh are reserved for firmware control.)

DESIGNING CUSTOM CHARACTERS

You can create "soft" (custom) characters, one at a time, and load them into a font bank.

NOTE: Because of the complexity of the process, we suggest you read the following explanations, including the example, before you attempt to program a soft character.

Anatomy of a Character Cell

The figures on the following pages illustrate the explanations below.

Each 965 character cell is a matrix of pixels whose dimensions vary according to the number of data lines on the screen:

Number of Data Lines	Character Cell Dimensions	Alphanumeric Character Dimensions
24, 25	10 x 16 (three-pixel descenders)	7 x 11
42, 43 48, 49	10 x 10 (one-pixel descenders)	5 x 7

NOTE: The number of columns per line (80 or 132) does not affect the dimensions measured in pixels of the character cell and alphanumeric character. The characters are smaller because the pixels are closer together.

The vertical columns of the character cell are numbered from bit 7 (most significant bit) to bit 0 (least significant bit), plus A and B. (A and B are not included in the programming command bit count.)

Note that the alphanumeric character matrix (indicated by c's and d's in the figures) is confined to columns 7 through 1. Only graphics characters extend into columns 0, A, and B.

The bit value of pixels in column 0 (one or zero) is automatically duplicated in columns A and B. This permits graphics characters to extend completely across the character cell, so that adjacent characters can touch to form a larger figure. (Graphics figures may also extend from scan line 1 through line 16, for the same reason.)

Scan Line	Alphanumeric Characters								Graphic Characters Only		
	Bit 7	Bit 6	Bit 5	Bit 4	Bit 3	Bit 2	Bit 1	Bit 0	A	B	
1	x	x	x	x	x	x	x	x	x	x	
2	c	c	c	c	c	c	c	x	x	x	
3	c	c	c	c	c	c	c	x	x	x	
4	c	c	c	c	c	c	c	x	x	x	
5	c	c	c	c	c	c	c	x	x	x	
6	c	c	c	c	c	c	c	x	x	x	Character
7	c	c	c	c	c	c	c	x	x	x	Body
8	c	c	c	c	c	c	c	x	x	x	
9	c	c	c	c	c	c	c	x	x	x	
10	c	c	c	c	c	c	c	x	x	x	
11	c	c	c	c	c	c	c	x	x	x	
12	c	c	c	c	c	c	c	x	x	x	
13	d	d	d	d	d	d	d	x	x	x	
14	d	d	d	d	d	d	d	x	x	x	Descenders
15	d	d	d	d	d	d	d	x	x	x	
16	x	x	x	x	x	x	x	x	x	x	

10 x 16 Character Cell
 7 x 11 Alphanumeric Character
 Three-line Descenders

Scan Line	Alphanumeric Characters								Graphic Characters Only		
	Bit 7	Bit 6	Bit 5	Bit 4	Bit 3	Bit 2	Bit 1	Bit 0	A	B	
1	x	x	x	x	x	x	x	x	x	x	
2	c	c	c	c	c	x	x	x	x	x	
3	c	c	c	c	c	x	x	x	x	x	
4	c	c	c	c	c	x	x	x	x	x	Character
5	c	c	c	c	c	x	x	x	x	x	Body
6	c	c	c	c	c	x	x	x	x	x	
7	c	c	c	c	c	x	x	x	x	x	
8	c	c	c	c	c	x	x	x	x	x	
9	d	d	d	d	d	x	x	x	x	x	Descenders
10	x	x	x	x	x	x	x	x	x	x	

10 x 10 Character Cell
5 x 7 Alphanumeric Character
One-line Descenders

Each pixel in the matrix is assigned a bit value of zero if it is background (not displayed in the character) or a bit value of one if it is foreground (displayed in the character).

For example, shown below is the pixel matrix of the uppercase Greek character sigma, in a 10 x 16 character cell. This character extends a line above and a line below the normal alphanumeric character matrix, but does not extend into column 0.

Scan Line	Bit									
	7	6	5	4	3	2	1	0	A	B
1	1	1	1	1	1	1	1	0	0	0
2	0	1	0	0	0	0	0	0	0	0
3	0	0	1	0	0	0	0	0	0	0
4	0	0	0	1	0	0	0	0	0	0
5	0	0	0	0	1	0	0	0	0	0
6	0	0	0	0	0	1	0	0	0	0
7	0	0	0	0	0	0	1	0	0	0
8	0	0	0	0	0	1	0	0	0	0
9	0	0	0	0	1	0	0	0	0	0
10	0	0	0	1	0	0	0	0	0	0
11	0	0	1	0	0	0	0	0	0	0
12	0	1	0	0	0	0	0	0	0	0
13	1	1	1	1	1	1	1	0	0	0
14	0	0	0	0	0	0	0	0	0	0
15	0	0	0	0	0	0	0	0	0	0
16	0	0	0	0	0	0	0	0	0	0

Creating a Soft Character

Create and load
a soft character

DEFAULT Pb/Pp = 0
ESC x A Pb Pp B₁ ... B_n CTRL Y

Pb = A decimal number from 0 to 3 indicating the font bank that contains the target character set

Pp = A two-byte hex value between 00h and 7Fh defining the position of the character in the font bank

The characters created in this command are intended to load into the soft character set (selected with variable Ps = H in the command to load a character set into a font bank). You may also load a soft character into an existing character set, overwriting the character in the selected position.

NOTE: Do not confuse the hex values for the 128 *positions* with the hex values of the actual characters themselves. Each font bank has 128 character positions, even when the characters themselves are in the range 80h-FFh.

B₁ ... B_n = 32 or 20 single hexadecimal figures (0h-Fh) derived from the binary values of scan lines 1 through 16 (large cell) or 1 through 10 (small cell). Read on:

Each scan line has an eight-bit binary value found by assigning a value of 1 to foreground pixels in the character and a 0 value to background pixels.

However, the character creation command uses hexadecimal numbers to define the composition of each scan line. To derive the hex value for each line, convert its eight-bit binary value into a two-character hex value, using the ASCII and supplemental character code tables in Appendix B. Depending on whether you are creating a character in a 10 x 16 or 10 x 10 character cell, the command requires 32 or 20 figures.

NOTE: Since the command requires a series of single hex figures, you can more easily find them by dividing each scan line into most-significant and least-significant four-bit units ("nibbles"). The units will range in value from 0h to Fh. Just be sure to enter all the figures in the correct sequence: from the most-significant four-bit unit of scan line 1 through the least-significant four-bit unit of scan line 16 or 10.

Example

Suppose you want to create the Greek letter sigma, and you want to put it in the 33rd position of font bank 3:

1. Lay out a grid of the character cell and design the character you want. If desired, leave room at the top and bottom of the character for separation from the lines above and below. Remember that pixel values in column 0 are duplicated in columns A and B.
2. Calculate the binary value of each scan line. Assign hex values to the most-significant and least-significant four-bit units:

Line	Binary		Hex
	MSB (7-4)	LSB (3-0)	
1	1 1 1 1	1 1 1 0	F E
2	0 1 0 0	0 0 0 0	4 0
3	0 0 1 0	0 0 0 0	2 0
4	0 0 0 1	0 0 0 0	1 0
5	0 0 0 0	1 0 0 0	0 8
6	0 0 0 0	0 1 0 0	0 4
7	0 0 0 0	0 0 1 0	0 2
8	0 0 0 0	0 1 0 0	0 4
9	0 0 0 0	1 0 0 0	0 8
10	0 0 0 1	0 0 0 0	1 0
11	0 0 1 0	0 0 0 0	2 0
12	0 1 0 0	0 0 0 0	4 0
13	1 1 1 1	1 1 1 0	F E
14	0 0 0 0	0 0 0 0	0 0
15	0 0 0 0	0 0 0 0	0 0
16	0 0 0 0	0 0 0 0	0 0

3. Send ESC x A to begin the command sequence. If you are entering this command from the keyboard, press the LOC ESC key.

4. Enter the variables for the font bank and character position:

Variable	Value	Specifies
Pb	3	Font bank 3
Pp	20	The 33rd position in the font bank

5. Enter the string FE 40 20 10 08 04 02 04 08 10 20 40 FE 00 00 00 for the character sigma. Be sure you send all 32 figures.

6. Enter CTRL Y to end the command.

The complete command is

ESC x A 3 20 FE4020100804020408102040FE000000 CTRL Y

BLOCK GRAPHICS

You can draw two types of blocks. Chapter 7 contains commands to clear a rectangle and to fill it with specified characters.

Creating a Measured Block

Define a block

ESC H w h

w = An ASCII character from the cursor coordinate table in Appendix F whose row/column number equals the width of the block, measured in columns. The top and bottom lines start at the cursor position and extend to the right.

h = An ASCII character from the cursor coordinate table in Appendix F whose row/column number equals the height of the block, measured in rows. The sides start at the cursor position and extend down.

A block created with this command may extend on a page or a defined scrolling region beyond the edge of the display. But a block defined to extend beyond the page or scrolling region ends at the right or bottom margin.

The figure below shows how the screen might appear with three overlapping blocks created with this command.

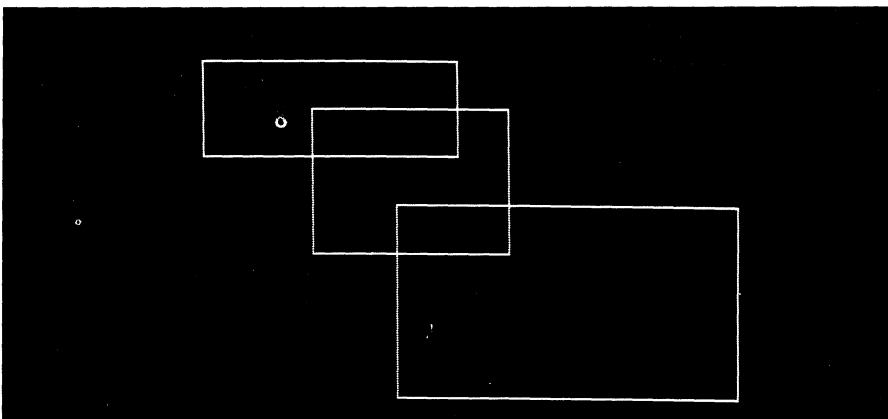

Creating a Positioned Block

Define a block

ESC x G r c

- r = An ASCII character from Appendix F for the row (line) at which the sides of the block, extending from the cursor row, terminate.
- c = An ASCII character from Appendix F for the column at which the top and bottom of the block, extending from the cursor column, terminate.

The variables r and c define the row and column that are two sides of the box. The cursor anchors the corner opposite the junction of r and c. The lines drawn with this command may extend above or below the cursor, and to the right or left.

A block created with this command may extend on a page or a defined scrolling region beyond the edge of the display. But a block defined to extend beyond the page or scrolling region ends at the right or bottom margin.

9 DATA TRANSMISSION

Programming the Ports	9.1
Selecting the Host Communication Port	9.1
Programming the Port Parameters	9.2
Data Word Mode	9.3
Selecting the Transmit Delay Rate	9.3
Handshaking Protocols	9.4
Selecting Handshaking Protocols	9.4
Sending X-On/X-Off Characters	9.4
Transmission Control Mode	9.5
Receive Buffer Fill Limit	9.5
Data Acknowledge Mode	9.5
Data Transmission Modes	9.6
Setting the Host Communication Mode	9.6
Setting the Printer Port Mode	9.8
Sending Text	9.9
Block Start Mode	9.9
Block End Mode	9.9
Delimiters	9.9
Reprogramming Delimiters	9.10
Defining Text Blocks for Transmission	9.11
Page Send Commands	9.12
Page Print	9.16
Page Print Commands	9.17
Page Print Flip Mode	9.17
Page Print Termination Signal	9.17

9 DATA TRANSMISSION

This chapter presents the commands that control data communication parameters and transmission.

PROGRAMMING THE PORTS

These commands let you configure the main and auxiliary ports for host or printer communication.

Selecting the Host Communication Port

Select the main port for host communication
Select the auxiliary port for host communication

SET-UP
DEFAULT = Main
ESC [= 22 /
ESC [= 22 h

When you select one port for host communications, the other port becomes the printer port. This means the port selected for host communications assumes the current host communication mode (full or half duplex, block, local) and the terminal directs data to the host through that port. Likewise, the port selected for printer communication assumes the current print mode, and the terminal directs data to the printer through that port.

However, the physical ports, main and auxiliary, retain their previous communication format (baud rate, stop bits, parity, data bits), transmit and receive handshaking protocol, and port pin-outs.

For example, when you select the auxiliary port for host communication, the terminal sends data to the host through it. But the port's default communication format remains the same (i.e., 1200 baud), and it is still a DCE port (see the port pin-out tables in Chapter 11).

Programming the Port Parameters

SET-UP

DEFAULT p1 = > (main), 8 (aux);
p2/p3/p4 = 0

Reprogram the main port

ESC { p1 p2 p3 p4

Reprogram the auxiliary port

ESC } p1 p2 p3 p4

p1	Baud Rate	p1	Baud Rate
1	50	9	1800
2	75	:	2400
3	110	;	3600
4	135	<	4800
5	150	=	7200
6	300	>	9600
7	600	?	19200
8	1200	@	38400 ¹

p2	Stop Bits	p4	Word Length
0	1	0	8 bits
1	2	1	7 bits

p3	Parity	p3	Parity
0	No		
1	Odd (receive/transmit)	5	Mark
3	Even (receive/transmit)	7	Space

This command assigns communication values to the main or auxiliary port, regardless of whether you have selected the port for host or printer communication. The changes are temporary; unless you save the new values in nonvolatile memory, they are lost after a reset.

¹Main port only.

For example, if you enter

ESC } < 0 3 1

the auxiliary port values become

Baud rate	4800
Stop bits	1
Parity	Even
Word length	7 bits

Data Word Mode

SET-UP
DEFAULT = 7 bits
ESC [= 1 l
ESC [= 1 h

Read 7-bit data words

Read 8-bit data words

7-bit words The terminal ignores (masks) the eighth bit in each data word received from the host.

8-bit words The terminal reads all eight bits of received data words. This permits the terminal to interpret and generate characters in the code range A1h to FEh without any special character set commands. (The characters at A0h and FFh are reserved for firmware control.)

NOTE: Although special graphics characters are contained in the character generator at positions 80h through 9Fh, generating them by sending those codes from the host may cause software incompatibilities.

Selecting the Transmit Delay Rate

SET-UP
DEFAULT = 0
ESC [0 ; Pn v

Select the character transmit delay rate

Pn = 0 to 7 character delays per character transmitted

This command causes the terminal to insert from zero to seven character delays per character transmitted. It does not change the baud rate.

HANDSHAKING PROTOCOLS

Selecting Handshaking Protocols

SET-UP

Disable main port X-On/X-Off; enable DTR line	CTRL N
Enable main port X-On/X-Off; disable DTR line	CTRL O
Select the main port receive protocol ¹	ESC [1 ; Ps v
Select the main port transmit protocol ²	ESC [11 ; Ps v
Select the auxiliary port receive protocol ³	ESC [12 ; Ps v
Select the auxiliary port transmit protocol ⁴	ESC [13 ; Ps v

Ps Protocol

- | | |
|---|--|
| 0 | No protocol |
| 1 | X-On/X-Off |
| 2 | DTR (main receive, aux transmit)
DCD/DSR (main transmit)
DSR (aux receive) |
| 3 | Both (except main transmit) |

CTRL N and CTRL O are compatible with the 955 command set. They apply only to the main port receive protocol.

These commands set the protocol mode; the commands below are the actual X-On/X-Off signals.

Sending X-On/X-Off Characters

Enable transmission (X-On)	CTRL Q
Disable transmission (X-Off)	CTRL S

If the handshaking protocol between the host and the main port is X-On/X-Off, the host can command the terminal to stop sending characters with the X-Off (DC3) command. Sending X-On (DC1) signals the terminal to resume sending characters.

¹Default is X-On/X-Off.

²Default is no protocol.

³Default is DSR.

⁴Default is both.

Transmission Control Mode

SET-UP
DEFAULT = Off
ESC [= 0 h
ESC [= 0 l

Transmission control on
Transmission control off

Transmission control on When X-On/X-Off is selected as the main port receive protocol, the terminal accepts signals from the computer.

Transmission control off The terminal ignores X-On/X-Off signals from the computer.

Receive Buffer Fill Limit

SET-UP
DEFAULT Ps = 0
ESC [2 ; Ps v

Select the receive buffer fill limit

Ps	Fill Limit (Bytes)
0	16
1	32
2	64
3	128

When the main port receive buffer fills to the selected limit, the terminal signals the host to stop sending data.

Data Acknowledge Mode

DEFAULT = On
ESC [= 28 h
ESC [= 28 l

Enable data acknowledge mode
Disable data acknowledge mode

Mode enabled The terminal sends the ASCII ACK character (06h) to the computer, to indicate it is ready to receive data, after the following operations:

- * Changing the main or auxiliary port operating values
- * A page print
- * Loading or clearing a font

DATA TRANSMISSION MODES

Setting the Host Communication Mode

	SET-UP
	DEFAULT = FDX
Enable local mode	ESC c
Enable block mode	ESC B
Enable full duplex mode	ESC D F
Enable half duplex mode	ESC D H
Return to previous conversational mode (half or full duplex) from block or local mode	ESC C

These commands let you move between communication modes during a program. Of course, once you enable local mode, the operator must change the mode to re-establish communication with the computer. Keep in mind that your choice of communication mode always applies the port designated for host communication.

Table 9-1 describes each communication mode, and Figure 9-1 shows how data flows in each mode.

Communication Modes

Table 9-1

Name	Effect
Local	No communication with the computer.
Block	Keyboard data and editing key codes go only to the screen, as in local mode. When the terminal receives a send command (see the next section), it transmits screen data to the computer. The terminal can receive data from the computer during block mode.
Half duplex	The terminal sends keyboard entries to the screen and to the computer at the same time.
Full duplex	The terminal sends keyboard entries only to the computer. (The computer may echo keystrokes back to the terminal.) The terminal can transmit and receive simultaneously.

Data Flow in Host Communication Modes
Figure 9-1

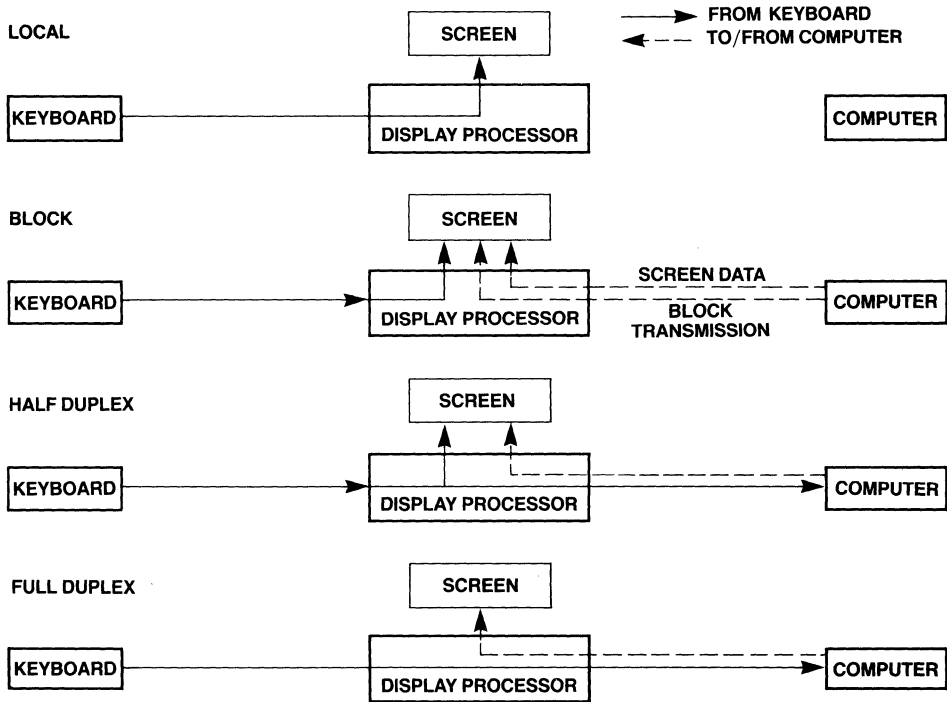

Setting the Printer Port Mode

Enable buffered copy print
Disable buffered copy print

Enable buffered transparent print
Disable buffered transparent print

Enable buffered bidirectional communication
Disable buffered bidirectional communication

Enable secondary receive mode
Disable secondary receive mode

SET-UP
DEFAULT = Off
ESC @
ESC A

ESC '
ESC a

CTRL R
CTRL T

ESC [= 27 h
ESC [= 27 l

The printer port communication mode determines how data is transmitted through the 965 to or from a device connected to the port configured as the printer port.

All the printer port modes are *buffered*. This permits the main and printer port baud rates to differ.

Copy print mode Data from the host or keyboard goes both to the screen and printer.

Transparent print mode Data from the host or keyboard goes to the printer only. The screen display freezes.

Bidirectional mode Data from the host or keyboard goes to both the screen and peripheral device. Data sent from the peripheral goes to the host only.

Secondary receive mode Data from the host or keyboard goes only to the screen. Data from the device connected to the printer port goes to the host only.

You can send data to the printer port with a page print command during any printer port mode.

Chapter 1 contains an illustration of the flow of data in print modes.

SENDING TEXT

This section tells how to send screen data to the host port in a *page send* or to the auxiliary port in a *page print*.

Block Start Mode

	DEFAULT = Page
Start the data block at the top of the page	ESC [= 17 l
Start the data block at the top of the display	ESC [= 17 h

This command applies to data sent with a block send command, the SEND key, a page print command, or the PRINT key.

Block End Mode

	DEFAULT = Cursor
End the data block at cursor position	ESC [= 18 l
End the data block at the end of the display	ESC [= 18 h

This command defines the end of the block.

Delimiters

The terminal automatically inserts field, line, and message delimiters in a page send.

The control characters listed in Table 9-2 are the default delimiters. If you don't want these characters in your transmissions, you can reprogram them with the commands in the next section.

NOTE: The terminal does not transmit the nulls in the delimiter codes to the computer.

Default Delimiter Values
Table 9-2

Delimiter	ASCII Character	Byte Value (in hex)
Field separator	FS NUL	1C 00
Start protected field	ESC)	1B 29
End protected field	ESC (1B 28
End of line	US NUL	1F 00
End of message	CR NUL	0D 00

Reprogramming Delimiters

SET-UP

Reprogram delimiter characters

ESC x Ps p1 p2

Ps Delimiter

- 0 Field separator
- 1 End of line
- 2 Start of protected field
- 3 End of protected field
- 4 End of message

p1/p2 = Any ASCII characters

This command changes the delimiters included when the terminal sends screen data.

If you don't want any delimiters, program p1 and p2 as null characters. The terminal does not send null characters to the host in a delimiter.

The reprogrammed delimiter characters are saved in nonvolatile memory.

Defining Text Blocks for Transmission

The ASCII start-of-text (STX) and end-of-text (ETX) control characters (hex 02 and 03) define the portion of text transmitted by the page send commands ESC S and ESC s (presented on the next page). Insert these characters where you want the block to begin and where you want it to end.

Normally the terminal does not display ASCII control characters on the screen. But you can display a control character, as if it were an alphanumeric character, in two ways: Position the cursor where you want the STX or ETX character (remember, the character occupies a space in the display), then

- * From the keyboard, press LOC ESC (SHIFT-ESC), then CTRL-B or CTRL-C
- or
- * From a program, enable monitor mode, then send CTRL-B or CTRL-C.

Page Send Commands

Send unprotected characters in cursor line up to and including cursor	ESC 4
Send unprotected page up to and including cursor	ESC 5
Send entire line of data up to and including cursor	ESC 6
Send entire page up to and including cursor	ESC 7
Send unprotected data between STX ¹ and ETX ² characters	ESC S
Send all data between STX ¹ and ETX ² characters	ESC s

During full or half-duplex modes, data entered at the keyboard goes to the computer immediately, but during block mode, sending it to the computer is a separate step. You can either press the SEND key or enter one of these commands to send a text block.

These commands define the data sent to the computer in a page send. If the data contains more than one set of STX and ETX characters, the STX character above and nearest the cursor and the following ETX character define what goes to the computer.

You cannot send data to the computer in local mode.

Table 9-3 describes the effect of send commands. Turn back to Table 9-2 for default delimiter values.

¹If no STX character is present, data starts at the position defined by block start mode.

²If no ETX character is present, data ends at the position defined by block end mode.

Send Commands
Table 9-3

Command	Effect
Send unprotected line (ESC 4)	Sends all unprotected data on the line between column one and the cursor. Delimiters Sends a field separator in place of each protected field and a termination character after the transmission.
Send unprotected page (ESC 5)	Sends unprotected data between the first unprotected position and the cursor. Delimiters Sends a field separator for each protected field, line delimiter after each line, and a termination character after the transmission.
Send entire line (ESC 6)	Sends all data between the first and the cursor positions. Delimiters Sends a termination character after the transmission. Brackets protected fields with start and end protected field delimiters. ¹
Send entire page (ESC 7)	Sends all data between the first and the cursor positions. Delimiters Sends line delimiter after each line and a termination character after the transmission. Brackets protected fields with start and end protected field delimiters. ¹

¹When protect mode is on, a field of graphics characters is bracketed by ESC \$ and ESC %, and the terminal sends ESC G Ps for visual attributes.

Send Commands
Table 9-3 (continued)

Command	Effect
Send unprotected passage (ESC S)	<p>Sends all unprotected data between either STX character (if the cursor follows an STX character) or first unprotected position (if the cursor is before the STX character) and ETX character. Cursor moves to ETX character.</p> <p>If the page has no ETX character, sends all unprotected data between either the STX character (if cursor follows STX character) or the first unprotected position (if the cursor is before the STX character) and the end of the page. Moves the cursor to the first unprotected position. If the page has no STX or ETX characters, sends all unprotected data.</p> <p>Delimiters Sends a field separator in place of each protected field, line delimiter after each line, and a termination character after the transmission.</p>

Send Commands
Table 9-3 (continued)

Command	Effect
Send entire passage (ESC s)	<p>Sends all data between the STX character (if the cursor follows the STX character) or home (if the page lacks an STX character or the cursor is before the STX character) and the ETX character. Moves the cursor to the ETX character.</p> <p>If page has no ETX character, the terminal sends all data between either the STX character (if the cursor follows the STX character) or home (if the cursor is before the STX character) and the end of the page. Moves the cursor to the home or first unprotected position.</p> <p>If page has no STX or ETX character, sends everything. Moves the cursor to home or the first unprotected position.</p> <p>Delimiters Sends a line delimiter after each line and a termination character after the transmission. Each protected field is bracketed by start and end protected field delimiters.¹</p>

¹When protect mode is on, a field of graphics characters is bracketed by ESC \$ and ESC %, and the terminal sends ESC G Ps for visual attributes.

Page Print

When the 965 receives a page print command, it sends a block of text to the printer or other device connected to the auxiliary port. The extent of the text block is determined by the setting of block start and block end modes.

A page print can be *formatted* or *unformatted*. A *formatted page print* sends a carriage return and a line feed after each line and space characters for all protected characters. An *unformatted page print* sends all characters, without any formatting controls, so the appearance of the printed copy is unpredictable.

Use a formatted page print for output to a printer. An unformatted page print command is appropriate for data transmissions to another type of data communication device, where control characters in the data file would be unwanted.

During a page print, the terminal flips the next page of display memory onto the screen, unless page print flip mode has been disabled. The 965 responds to the selected handshaking signals from the receiving peripheral during transmission.

After the transmission, the 965 sends ACK (hex 06) to the host as a signal to resume screen updating. If your computer does not need this signal, or may respond to it in an inappropriate way, you can reprogram the page print termination signal with the command presented later in this chapter.

NOTE: The 965 responds to a *page print* command during any print mode (page print is an action command, not a mode.)

Page Print Commands

Print unprotected formatted page	ESC P
Print all unformatted page	ESC L
Page print	ESC [0 ; Ps i

Ps	Amount Printed
0	Formatted all
1	Formatted unprotected
4	Unformatted all
5	Unformatted unprotected

Page Print Flip Mode

	SET-UP
	DEFAULT = On
Page print flip on	ESC [= 15 h
Page print flip off	ESC [= 15 l

Flip on The display flips to the next page of screen memory during page print, and the screen continues to accept data from the computer or keyboard.

Flip off The current page of memory remains displayed, and screen updating halts during transmission.

Page Print Termination Signal

	DEFAULT Ps = ACK
Define the page print termination signal	ESC p Ps

Ps = Any ASCII character

This command reprograms the ASCII character sent to the computer after each page print, to signal the end of the transmission. The reprogrammed value is saved in nonvolatile memory.

10 REPROGRAMMING CODES AND MESSAGES

Key Configuration Modes	10.1
Application Key Mode	10.1
WordStar Mode	10.1
Editing and Numeric Keys	10.2
Reprogramming One Key	10.2
Reprogramming a Set of Keys	10.3
The Function Keys	10.4
Selecting the Function Key Set	10.4
Loading Function Key Contents in Memory	10.4
Reprogramming the Function Keys	10.5
Loading the Function Key Labels	10.9
The FUNCT Key	10.10
Information Lines	10.11
Selecting the Contents of the Information Lines	10.11
Loading the User Messages	10.12
Sending the User Message	10.13
Terminal Identity Messages	10.15
The Answerback Message	10.15
Sending the Terminal Identification	10.15

10 REPROGRAMMING CODES AND MESSAGES

This chapter covers key codes, information line messages, and the terminal answerback and ID.

KEY CONFIGURATION MODES

Application Key Mode

Enable application key mode
Disable application key mode

DEFAULT = Off
ESC | = 23 h
ESC | = 23 /

Application key mode changes the codes sent by nearly all keys (except the main keypad alphanumeric keys) to eight-bit codes. Table D-2 in Appendix D shows the reconfigured key codes. The terminal must be in 8-bit data word mode when this mode is enabled.

NOTE: This mode overrides all other key reprogramming, including WordStar mode and function key, editing key, and numeric key reprogramming.

WordStar Mode

Enable WordStar mode
Disable WordStar mode

DEFAULT = Off
ESC | = 21 h
ESC | = 21 /

In WordStar mode, the editing and function keys send commands used by the WordStar application program. Table D-3 in Appendix D shows the WordStar key codes.

When this mode is enabled, a w shows in the status line.

NOTE: This mode overrides all other key reprogramming except application key mode.

EDITING AND NUMERIC KEYS

This section tells how to reprogram editing and numeric keypad keys. The reprogrammed codes are saved in nonvolatile memory.

Reprogramming One Key

Reprogram one editing or numeric key ESC 0 Ps p₁ ... p₅

Editing Key	Ps		Numeric Key	Ps
	Unshifted	Shifted		
HOME	@	`	0	0
DOWN	A	a	1	1
UP	B	b	2	2
LEFT	C	c	3	3
RIGHT	D	d	4	4
TAB (main)	E	e	5	5
BACK SPACE	F	f	6	6
CLEAR SPACE	G	g	7	7
PRINT	H	h	8	8
CHAR INSERT	I	i	9	9
CHAR DELETE	J	j	,	:
LINE INSERT	K	k	-	;
LINE DELETE	L	l	.	<
LINE ERASE	M	m	00	=
PAGE ERASE	N	n		
PAGE (NEXT/PREV)	O	o		
SEND	P	p		
TAB (keypad)	Q	q		
CE	R	r		
ENTER	S	s		
RETURN	T	t		
LINE FEED	U	u		
ESC	V	v		
DEL	W	w		

p₁ ... p₅ = Five bytes

You can load up to five bytes into any one editing or numeric keypad key with this command.

Reprogramming a Set of Keys

Reprogram a set of keys

ESC] Ps p₁ ... p_n

Ps	Key Set
0	Unshifted editing
1	Shifted editing
2	Unshifted numeric keypad

p_n = Five ASCII characters each, for all keys in the set

Use this command to reprogram most or all keys in a set, since you must enter, in order, five bytes each for all the keys in the set specified by Ps. Each set of keys, in the order it loads, is listed in the previous command to reprogram one key.

After receiving a value for Ps, the terminal assigns the next 120 bytes (for an editing key set), or 70 bytes (for the numeric keys) that it receives. Then the command automatically terminates. Enter null characters to fill up the required five bytes per key.

The following example starts you out reprogramming the unshifted editing keys. Remember to press the LOC ESC key if you are reprogramming from the keyboard.

1. Enter

```
ESC ] 1
```

to start the command and specify the shifted editing keys.

2. Enter, in a string without spaces, the following codes for the first three keys:

```
RS NUL NUL NUL NUL LF NUL NUL NUL NUL  
ESC j NUL NUL NUL
```

This string leaves the HOME key unchanged, then reverses the functions of the DOWN and UP keys.

3. Now continue entering five bytes of code apiece for the remaining editing keys.

THE FUNCTION KEYS

The 965 has four sets of function key memory, each with 256 bytes. Table D-1 shows the default codes for sets one and two. (Sets three and four have no default codes.) For more information about the function keys, read the section in Chapter 3 about reprogramming the function keys.

This section presents the following operations:

- * Selecting a function key set
- * Saving reprogrammed codes
- * Reprogramming the keys
- * Sending key codes from a program
- * Loading the function key labels

Selecting the Function Key Set

SET-UP
DEFAULT Ps = 0
ESC [7 ; Ps v

Select the function key set

Ps	Set
0	One
1	Two
2	Three
3	Four

The terminal does not save the new value in nonvolatile memory. When you reset the terminal, set one is again the active set, unless you send the command presented in Chapter 4 to save set-up values (or enter set-up and save the new value).

Loading Function Key Contents in Memory

SET-UP
DEFAULT = Nonvolatile
ESC [= 10 h

Load function key reprogramming in nonvolatile memory

Load function key reprogramming in temporary memory

ESC [= 10 /

If you elect to load key reprogramming in temporary memory, the keys return to default codes when you reset the terminal.

Reprogramming the Function Keys

SET-UP

Reprogram a function key

ESC | p₁ p₂ <message> CTRL Y

Key	p ₁		Key	p ₁	
	Unshifted	Shifted		Unshifted	Shifted
F1	1	A	F9	9	I
F2	2	B	F10	:	J
F3	3	C	F11	;	K
F4	4	D	F12	<	L
F5	5	E	F13	=	M
F6	6	F	F14	>	N
F7	7	G	F15	?	O
F8	8	H	F16	@	P

p₁ All Keys

<sp> Clear memory of current function key set
0 Load function keys in sequence from F1

p₂ Message Destination

1 Computer
2 Terminal (screen)
3 Computer and terminal
4 Printer

Select a value of p₁ to reprogram any individual key, clear all the keys, or load all the keys in sequence.

When p₁ = 0, separate each key's message with field separator (FS) delimiters (1Ch). Your command would look like this:

ESC | 0 p₂ <message F1> FS p₂ <message F2> FS p₂ <message F3> FS p₂ <message F4> FS ... p₂ <message Fn> CTRL Y

CAUTION! Count your bytes! You can program 256 bytes into each function key set, distributed among its keys as you wish. If the message you are entering exceeds the remaining number of unused bytes in the function key set, the terminal continues to load the message and destroys the existing messages in other keys.

If p_1 = a space character, you can omit the remaining command sequence (p_2 <message> CTRL Y). You need only enter

ESC | <space>

Think about where you want the message to go before you enter p_2 . If you send it only to the terminal ($p_2 = 2$), the computer cannot act on it. And if you send it only to the computer ($p_2 = 1$), the message may not appear on the screen. (Unless the computer echoes it back to the terminal.)

Each message can contain any combination of display and control characters. If you want to enter CTRL P or CTRL Y as part of the message, preface either character with CTRL P. Otherwise, the terminal interprets CTRL P and CTRL Y as part of the command.

For example, let's program shifted key F1 to tell the terminal to move the cursor to the end of the screen, display user message one (which reminds the operator to turn on the printer) on the bottom information line, and print the contents of the page on a printer connected to the terminal. We'll send these messages to the terminal as escape sequences.

1. Send (or press LOC ESC)

ESC |

to start the programming sequence.

NOTE: Press LOC ESC if you are entering the command from the keyboard.

2. Send (or press)

A

to specify the shifted F1 key

3. Send (or press)

2

to send the message to the terminal.

Now everything you enter after this and before CTRL Y (Steps 4, 5, and 6) is part of the message that goes to the terminal when you press F1.

4. Send (or press)

ESC = 7 o

to address the cursor to the end of the screen. This defines the amount printed with the page print command in the next step. 7 and o are values from Appendix F that indicate the row (line) and column position.

5. Send (or press)

ESC g

to display user message one on the bottom line.

6. Send (or press)

ESC P

to command the terminal to print an unprotected, formatted page.

7. Send (or press)

CTRL Y

to end the command.

To calculate the bytes in this example, let's look at the entire command. The message portion appears in **bold type**.

ESC | A 2 **ESC = 7 o ESC g ESC P CTRL Y**

Now let's tally the bytes. Remember, you only count the bytes in the message.

Entry	Bytes	Entry	Bytes
ESC	1	ESC	1
=	1	g	1
7	1	ESC	1
o	1	P	1

The message contains 8 bytes.

Now whenever the shifted F1 key is pressed, the terminal moves the cursor to the end of the screen, displays user message one, and prints the contents of the screen.

Sending the Contents of a Function Key

Send the contents of a function key

ESC [Pn |

Pn	Key
1-16	Unshifted 1-16
17-32	Shifted 1-16

This command sends the contents of the specified function key to its programmed destination, just as if you pressed the key.

Loading the Function Key Labels

Load function key labels

ESC _ Ps <msg> CTRL M

Field	Ps	
	Unshifted	Shifted
F1	@	P
F2	A	Q
F3	B	R
F4	C	S
F5	D	T
F6	E	U
F7	F	V
F8	G	W
F9	H	X
F10	I	Y
F11	J	Z
F12	K	[
F13	L	\
F14	M]
F15	N	^
F16	O	_(underline)
Entire line	()

<msg> = Up to nine characters per label or a 79-character line in 80-column mode
Up to seven characters per label or a 131-character line in 132-column mode

NOTE: In 80-column mode, the labels for keys F8 and F16 (unshifted and shifted) contain only eight characters.

This command loads labels or a full-line message (similar to a user message) into the function key label lines. The operator must elect in set-up to display the labels in the information lines.

The following chart shows the contents of the function key label lines when the terminal is in 80- or 132-column mode:

Label Line	Number of Columns	
	80	132
1	F1-F8	F1-F16
2	F9-F16	NA

Note that in 132-column mode, label line 2 has no contents.

Shifted Label Mode

DEFAULT = Enabled

Enable shifted label mode

ESC _ *

Disable shifted label mode

ESC _ +

Normally, the operator can display labels of the shifted function keys by pressing the SHIFT key (alone). Disabling shifted label mode disables this function.

THE FUNCT KEY

The FUNCT key sends the ASCII code of the next alphanumeric key pressed, bracketed by the start-of-header (SOH) and carriage return (CR) control characters. It works only with alphanumeric keys; don't press it with an editing key.

Press *and hold down* the FUNCT key while you press the other key, as you would the SHIFT or CTRL key.

INFORMATION LINES

The top and bottom information areas can display the following reprogrammable information:

- * Time of day (status line)
- * Status line message
- * Two user messages
- * Function key labels

This section lets you select the contents of the top and bottom information lines, load the messages, and send them to the computer. It contains several commands that are redundant or overlapping, for the sake of programming compatibility.

See Chapter 1 for more details about the information lines. Appendix G contains a list of all status line messages.

NOTE: If the screen is configured for 25, 43, or 49 data display lines, the last data line overwrites the bottom information line.

Selecting the Contents of the Information Lines

Display user message one on bottom line
Turn off bottom status or message line
Display the status line on the top line
Turn off the top line display
Select the contents of the top line
Select the contents of the bottom line

SET-UP
DEFAULT Ps = 1/0
ESC g
ESC h
ESC . b
ESC . c
ESC [4 ; Ps v
ESC [5 ; Ps v

Ps Type of Information

0 Blank
1 Status line
2 User message one
3 User message two

Note that these commands do not include the function key label lines. The previous section about the function keys tells how to load function key labels; the operator must elect in set-up to display them.

Loading the User Messages

Load text into user message one

ESC f <text> CTRL M

Load text into a user message

ESC _ PI Ps <text> CTRL M

PI User Message

0 Message field in status line

1 User message one

2 User message two

Ps Effect

0 Clears message before loading

1 Writes over existing message

NOTE: These messages are not saved in nonvolatile memory.

You can enter 79 or 131 display characters and commands in the user messages. Like the screen's other display lines, the information lines contain 80 or 132 character positions. However, the first character of a message line is always the current visual attribute (default is reverse video). You can change this visual attribute, but you cannot write over it with a display character.

The status line message field contains 30 characters.

Until you enter text in a message line, it is blank (except for the visual attribute in the first character position).

The following example shows how to enter text into user message one on the bottom information line. If you are entering these commands from the keyboard, press LOC ESC (SHIFT-ESC).

1. Display user message one on the bottom information line (if you want to see the message as you enter it) with

ESC g

or

ESC [5 ; 2 v

2. Enter

ESC f

or

ESC _ 1 0

to clear the previous text and start loading new text into user message one.

3. Change the visual attribute in the first character position if desired. The default attribute is reverse video.

4. Enter up to 79 or 131 characters of text. If you displayed the message line before entering text, you can see the message as you enter it.

5. You can also include visual attributes any place in the message with the command ESC G Ps. Remember to include any commands in the character count.

6. Enter

CTRL M

to end the message.

Sending the User Message

Send a user message to the computer

ESC Z Ps

Ps Message

- 0 User message one
- 1 Message field in status line
- 2 User message two

This command sends the desired message to the computer. It does not display the message in an information line.

Loading the Time of Day

Load the time of day

ESC x 8 hh mm

hh = two-digit number for the hour

mm = two digit number for the minute

This command loads the time in the VideoDesk clock. You can select there to display the time and/or date in the status line.

Enter military (24-hour) time. For example, to load three o'clock in the afternoon, enter

ESC x 8 1500

TERMINAL IDENTITY MESSAGES

The Answerback Message

Program the answerback message	ESC ^ <msg> CTRL Y
Send the answerback message	CTRL E

The default answerback message is blank. You can program up to 16 control or display characters in the answerback message. To include CTRL Y or CTRL P as a character in the message, precede them with CTRL P (which is not counted as a character in the message). Otherwise, the terminal interprets these codes as part of the command.

The terminal stores the reprogrammed message in nonvolatile memory.

The terminal sends the answerback message to the host when it receives CTRL E.

Sending the Terminal Identification

Send terminal identification	ESC M
-------------------------------------	--------------

When the terminal receives this command, it returns the identification message TVS965 R.0 CTRL M to the computer.

R = Firmware revision level
0 = Firmware revision sublevel

11 INSTALLATION

Before You Start	11.1
Interface Types and Cables	11.1
Checking the Voltage Setting	11.2
Choosing a Site for the 965	11.3
Installation Steps	11.4
Unpacking the 965	11.4
Attaching the Keyboard	11.5
Connecting the 965 to a Computer	11.6
Connecting Your Printer to the 965	11.7
Plugging In the 965	11.8
Turning On the Power	11.9
RS-232C Signal Assignments	11.10
Port Pin-Outs	11.10
A Few Words About RS-232C	11.12

11 INSTALLATION

This chapter contains step-by-step instructions showing how to install the terminal. Following the installation steps is a section that contains information about connecting a computer or modem and a printer with RS-232C interfaces.

BEFORE YOU START

Before you start the installation process, plan your system layout:

- * Decide on a computer interface type and obtain all cables
- * Check the voltage setting
- * Prepare the site

After the terminal is installed, review Chapters 1, 2 and 3 for details about daily use and changing operating parameters in set-up.

NOTE: Immediately after installation, before going on line, enter set-up and perform a default reset. See Chapter 3 for instructions.

Interface Types and Cables

The type of interface you select depends on the distance between the host connection and the terminal.

If the distance between the terminal and your computer or modem is less than 50 feet, connect them with an RS-232C interface cable.

The 965 offers several interface options for distances greater than 50 feet, available through your dealer. They include RS-422, RS-423, current loop, external modem, and serial-to-parallel converter. Consult your dealer or distributor for help in selecting the correct interface.

The cables for connecting your terminal to a computer or modem and printer are not included with the terminal. The service technician in your organization should be able to obtain the necessary cables, or you can contact a computer supply dealer.

Checking the Voltage Setting

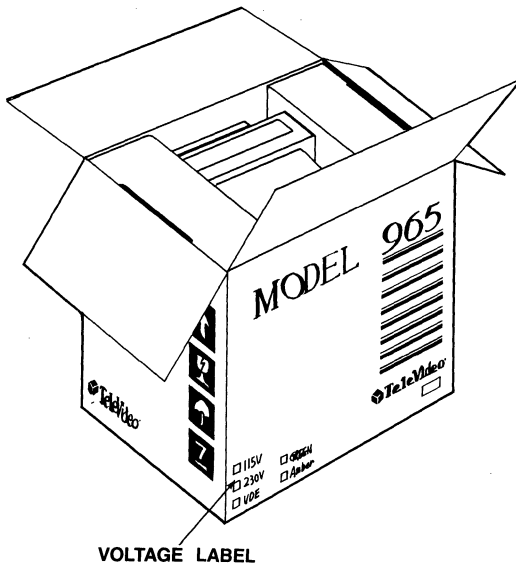

Before you connect the 965 to power or the computer line, make sure its voltage matches your outlet. Check the label on the carton stating whether its setting is 115 or 230 volts. Most U.S. power systems require 115 volts; most European systems require 230 volts.

Contact your dealer or distributor for instructions if you need to change the voltage setting.

Choosing a Site for the 965

(illustration of proper terminal location -- take figures from existing manuals)

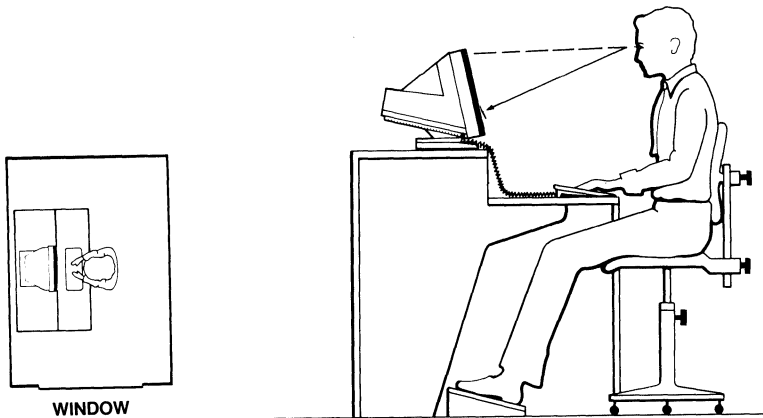

- * Choose a location with indirect lighting, away from windows or other sources of bright, direct light.
- * Allow 4 inches (10.2 cm) of clearance for ventilation on all sides.
- * Place the keyboard lower than the terminal screen.
- * Select furniture conducive to good working posture.

You can sit as close to the screen as you wish, without fear of radiation. Tests performed on TeleVideo terminals by Underwriters Laboratories indicate they emit virtually no radiation and pose no health hazard.

INSTALLATION STEPS

Review the entire installation procedure before you start. Make sure you have the necessary cables and have prepared a suitable location, as instructed in the previous sections.

STOP! Never open the terminal case. You can receive a serious electrical shock, even when the terminal is off and unplugged. Always call a service technician if you feel any service to the interior of the terminal is necessary.

Unpacking the 965

STEP 1

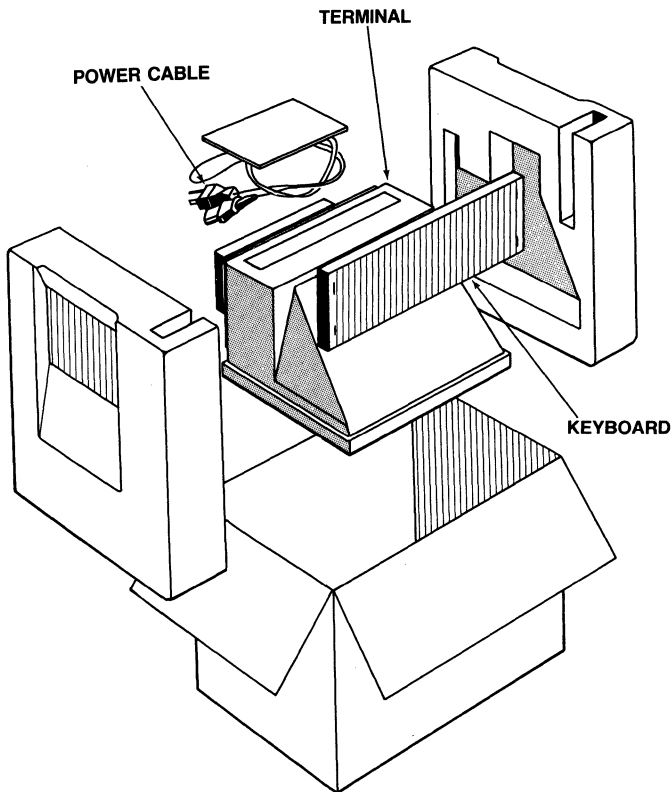

Inspect all parts for damage. If anything is missing or damaged, contact your distributor or dealer. Save the shipping material in case you move or ship the terminal again.

Attaching the Keyboard

STEP 2

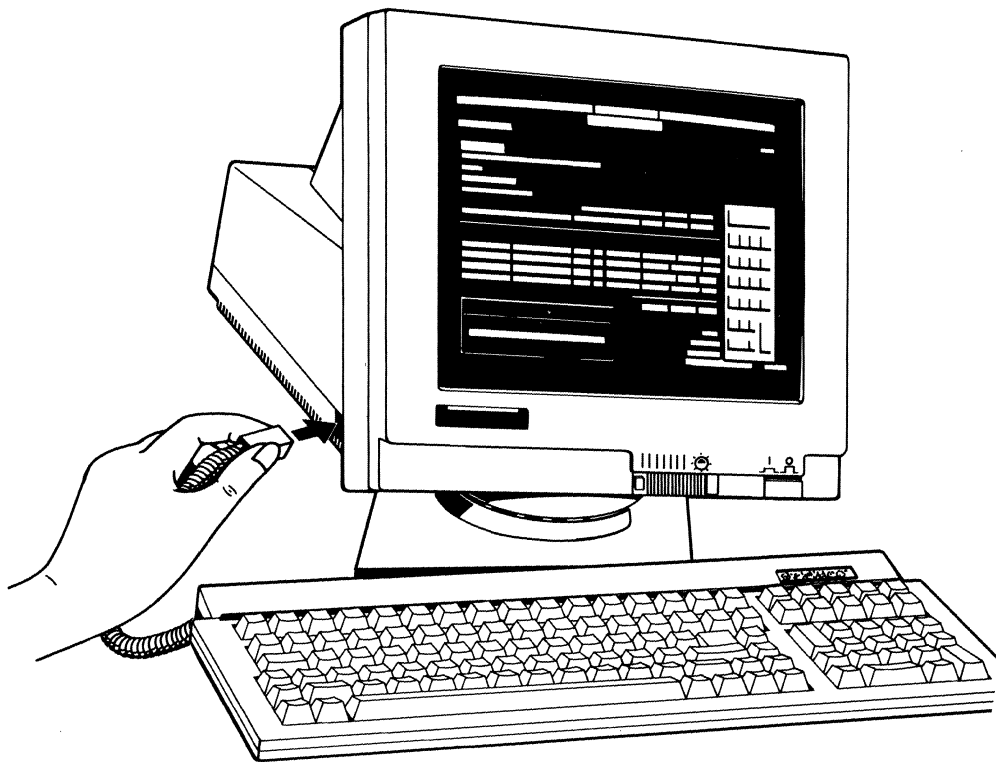

Plug the end of the coiled keyboard cable into the left side of the terminal.

CAUTION! Never disconnect or connect the keyboard when the power is on. Doing so can seriously damage the terminal.

965 VDT

11.5

Installation

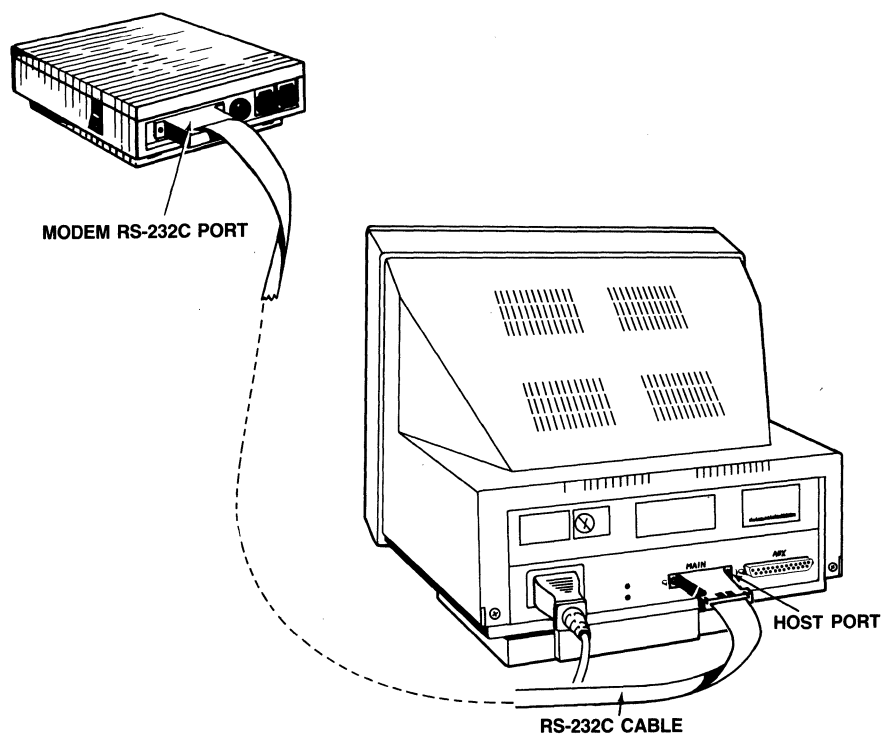

Make sure you are using the appropriate interface, as discussed at the beginning of this chapter. For an RS-232C interface, connect the cable between the 965 main port and the RS-232C port on the computer or modem. If you have to rewire the RS-232C connector for proper communication with the computer, see the pin signal tables at the back of this chapter.

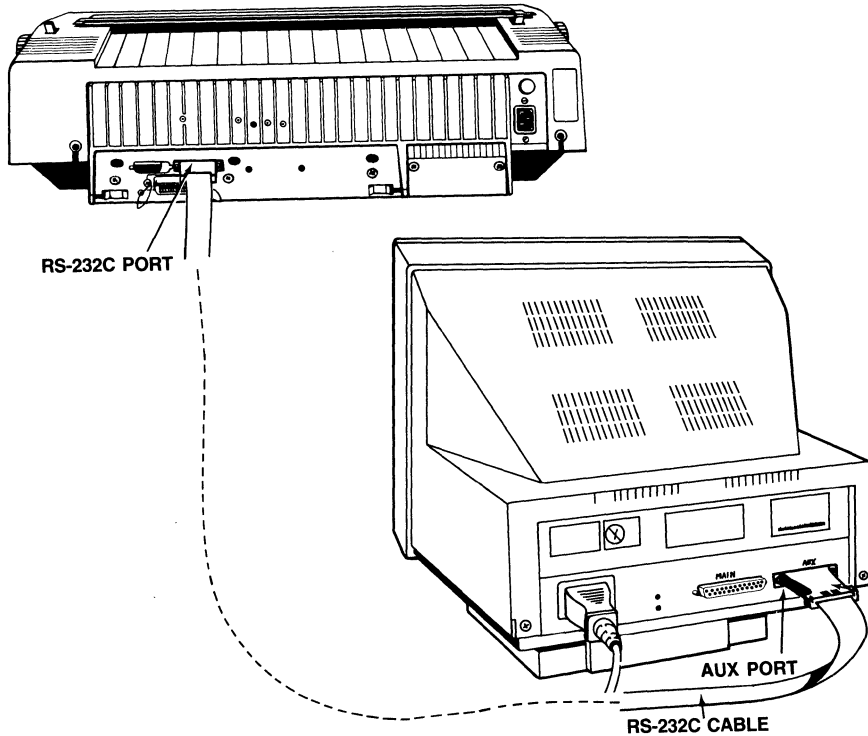

Check that your printer is set up to receive data through its serial port (check that it has a serial port!). Connect an RS-232C interface cable to the printer port on the 965 and the serial port on the printer. See the pin signal tables at the back of this chapter for information on configuring the cable connectors for proper communication.

Your application programs also affect printer operation. Consult your program manuals, check with a technician, or contact your dealer or distributor if you have problems getting your terminal and printer to communicate properly.

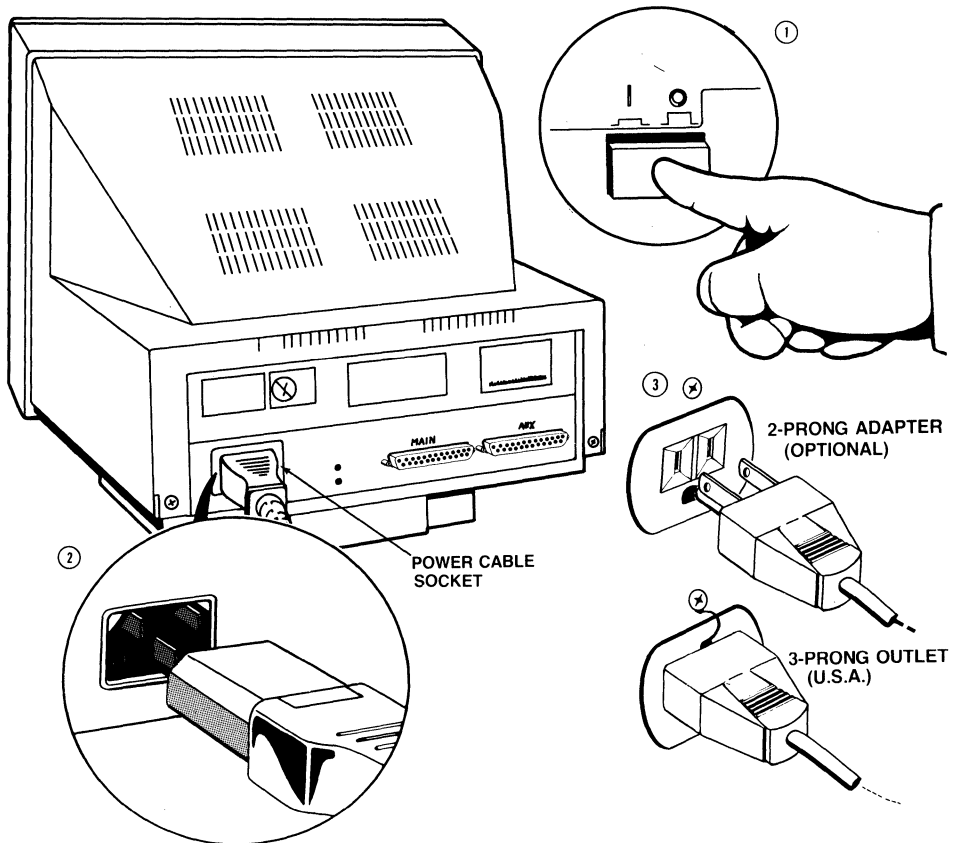

Make sure the power switch is OFF (not pushed in) before plugging in the 965.

Plug the power cable into the terminal *first*, then plug the cable into a grounded wall outlet.

NOTE: In the United States, use a 3-prong electrical outlet with a National Electrical Manufacturers Association (NEMA) Standard 5-15R rating. If you use a two-prong adapter, make sure it is properly grounded.

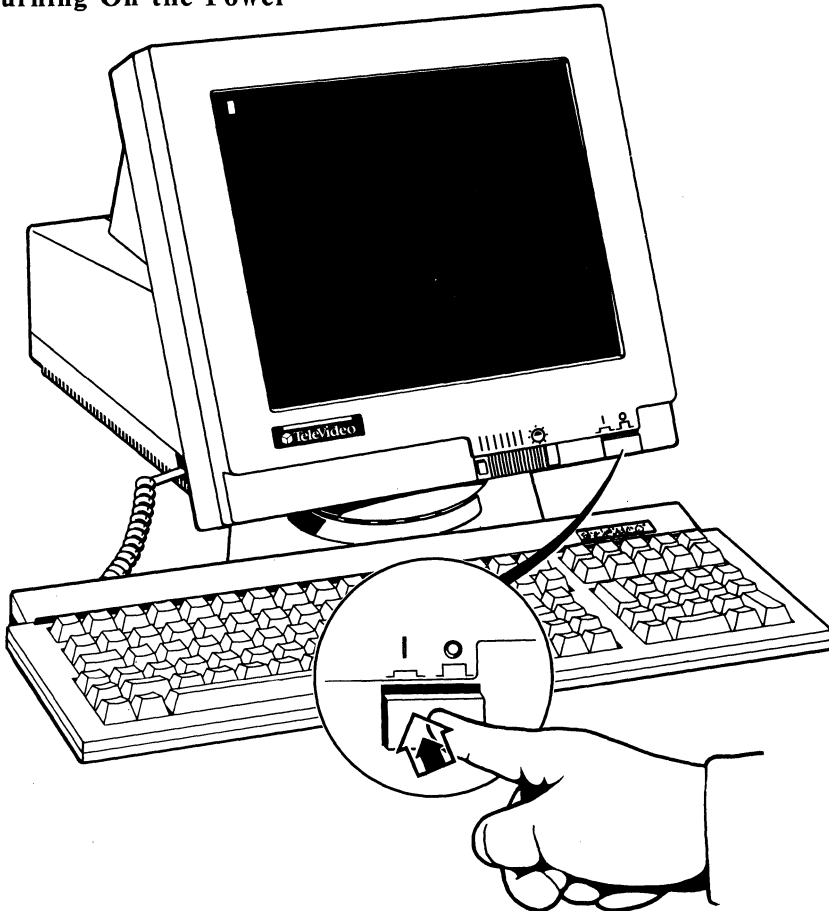

Press the power switch to turn on the terminal.

After a moment, the bell sounds; after 10 to 15 seconds the cursor appears.

NOTE: TeleVideo recommends that immediately after installation, before going on line, you enter set-up and perform a default reset. See Chapter 3 for instructions.

This completes the installation steps. See Chapter 1 for adjustment and operating instructions.

RS-232C SIGNAL ASSIGNMENTS

The 965 has two 25-pin D subminiature female EIA RS-232C data communication ports: a main (host) port and an auxiliary (printer) port.

This section contains pin-out tables for the two ports, followed by a brief, general description of the RS-232C communication standard.

Port Pin-Outs

When connecting the terminal to an RS-232C port on a host or peripheral, start by answering two questions:

- * Which signals does each unit require for proper communication? Typically, the 965 requires only Transmit Data, Receive Data, and Signal Ground (pins 2, 3, and 7) to communicate with a computer and printer.
- * Is the serial port for each interface a data communication equipment (DCE) or data terminal equipment (DTE) type? Note in Tables 11-1 and 11-2 that the 965 main port is a DTE port and the auxiliary port is a DCE port.

Main Port (DTE) Signal Assignments

Table 11-1

Pin No.	Signal Name	Direction
1	Frame Ground	n/a
2	Transmit Data	Output
3	Receive Data	Input
4	Request to Send	Output
5	Clear to Send	Input
6	Data Set Ready	Input
7	Signal Ground	n/a
8	Data Carrier Detect	Input
20	Data Terminal Ready	Output

Printer Port (DCE) Signal Assignments
Table 11-2

Pin No.	Signal Name	Direction
1	Frame Ground	n/a
2	Transmit Data	Input
3	Receive Data	Output
5	Clear to Send	Output
6	Data Set Ready	Output
7	Signal Ground	n/a
8	Data Carrier Detect	Output
20	Data Terminal Ready	Input

Check your computer and printer manuals for information about their port type, required signals, and signal direction. See the remarks following Table 11-3 if you are connecting the terminal to a modem.

If your computer has a 25-pin DCE port and your printer has a 25-pin DTE port, you should be able to connect the terminal to each with a standard interface cable, without any modifications.

However, your computer or printer may not have a 25-pin connector (some units have a 9-pin connector, for example). Or the DCE/DTE interfaces may not match up. In such cases, consult a technician or your dealer for assistance. This manual cannot specify pin connections for the multitude of nonstandard configurations available.

After you determine signal connections, you may find the cable connector needs rewiring. A service technician can rewire the connector, or your computer dealer may carry a ready-made adapter.

If your computer or printer fails to communicate properly after you connect them to the terminal, ask a service technician or your dealer for assistance.

A Few Words About RS-232C

RS-232C is an interface standard from the Electronic Industries Association. Its complete title is "Interface Between Data Terminal Equipment and Data Communication Equipment Employing Serial Binary Data Interchange." You can see why it's commonly just called RS-232C.

The RS-232C standard names and defines 20 communication signals, assigned to separate pins in a 25-pin connector. The five unassigned pins may carry nonstandard signals required by any particular system.

Each signal is transmitted as a positive or negative electric current between 3 and 15 volts. (Five and 12 volts are two commonly used voltages.) The signal assigned to each pin flows in one direction only. Signals *output* from a terminal must be *input* to a computer or printer, and vice versa.

25-Pin RS-232C Connector

Figure 11-1

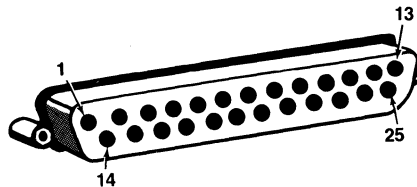

RS-232C signals travel over a serial interface cable that may have up to 25 wires, each of which can be attached to a pin in the connector at either end of the cable. Since most signals are not required for simple communication by a terminal, cables usually have less than 25 wires, with only the necessary wires attached to the connectors.

The signals flow between two types of interface port: data communication equipment (DCE) and data terminal equipment (DTE). Table 11-3 shows names, pin assignments, and directions of commonly required RS-232C signals.

Commonly Required RS-232C Signals
Table 11-3

Pin	Abbrev.	Name	Direction	
			DCE	DTE
1	FG	Frame Ground	n/a	n/a
2	TxD	Transmit Data	Input	Output
3	RxD	Receive Data	Output	Input
4	RTS	Request to Send	Input	Output
5	CTS	Clear to Send	Output	Input
6	DSR	Data Set Ready	Output	Input
7	SG	Signal Ground	n/a	n/a
8	DCD	Data Carrier Detect	Output	Input
20	DTR	Data Terminal Ready	Input	Output
22	RI	Ring Indicator	Output	Input

Pin signals 2 and 3 are the actual transmitted data. The others are control signals, ensuring that communication flows in an orderly fashion.

The 965 only needs connections to pins 2, 3, and 7. Most communication equipment requires a signal on pin 20, as well. Modems, multiplexers, and protocol converters often output other signals that lock up the 965. For example, all auto-dial modems lock the terminal up if pins 6 or 8 are connected from the modem to the terminal.

APPENDICES

- A Specifications**
- B Code and Character Sets**
- C Command Summaries**
- D Key Codes**
- E International Keyboards**
- F Cursor Coordinates**
- G Status Line Messages**

APPENDIX A SPECIFICATIONS

Part number	132985-00: White screen, 115V 132985-01: White screen, 230V 133040-00: Green screen, 115V 133040-01: Green screen, 235V
Case	Touch tilt (-5 to +26 degrees); swivel (360 degrees); front-mounted power switch and brightness adjustment; side-mounted keyboard connector
Screen	14 inches measured diagonally; P31 green or P4 white nonglare phosphor; screen saver; selectable on/off and background color
Configuration	12 set-up menus
Display format	Data lines: 24, 25, 42, 43, 48, 49 Information lines: top and bottom; status, user message, function key labels Columns: 80, 132, 80/132, 80 economy
Display memory	Up to seven pages
Character formation	24/25 data lines: 10 x 16 cell; 7 x 11 char. 42/43/48/49 data lines: 10 x 10 cell; 5 x 7 char.
Character sets	US ASCII standard (96 upper- and lowercase display with descenders, 32 control) and 955 multinational (8-bit); IBM ASCII and 8-bit multinational; Wyse 50; Wyse 50 graphics; 955 graphics; block graphics
Visual attributes	Character or page/line, embedded/nonembedded field; combinable full/half intensity blink, blank, underline, reverse
Line attributes	Combinable single/double high/wide
Cursor attributes	Block (blinking or steady), underline (blinking or steady), none

Cursor control	Home, up, down, right, left; carriage return, line feed, reverse line feed, new line; typewriter and field tabs (forward and backward); address, read
Editing	Character/line/column insert/delete; line/page/field erase; field/page/column/block clear; jump/smooth scroll, definable scrolling region, line lock; protect mode; insert/replace and page/line edit modes; programmable replacement character
Code compatibility	TeleVideo 910/910+, 912/920, 905/925, 950, 955; WY-60, WY-50/50+; ADM-3A/5/31, ADDS VP A2, DG200, Hazeltine 1500
Reprogrammable messages	Answerback, status line field, user, function key labels
Communication modes	Conversational (full or half duplex), block; local; secondary receive; local or duplex edit; monitor
Print capabilities	Formatted/unformatted page print; buffered copy, transparent, and bidirectional modes
Communication interfaces	RS-232C 256-character, buffered transmit/receive main and auxiliary ports; reconfigurable for host/printer communication; selectable character transmit delay rate; reprogrammable parameters
Word structure	7 or 8 data bits; 1 or 2 stop bits; 10- or 11-bit word
Parity	Odd, even, mark, space, or none
Baud rates	16 main, 15 auxiliary (50 to 38,400/19,200 KB)
Communication protocols	X-On/X-Off, DTR, DCD/DSR, none; reprogrammable send and print delimiters

Keyboard Detached, slim-line, typewriter-style with sculptured keycaps; sealed key switches; N-key rollover with ghost key lockout; accounting-style numeric keypad with TAB and ENTER keys; on/off repeat and keyclick; reprogrammable remote special keys

Power requirements 115/230 volt ac, 50/60 Hz

Dimensions

	Height (in.) (cm)		Width (in.) (cm)		Depth (in.) (cm)	
Cabinet	13.6	34.5	12.9	32.7	13.9	35.4
Keyboard	1.5	4.6	17.7	45.2	7.2	18.4
Footprint	8.6 x 8.0 in.					

Weight

Net 17.5 lb. (CRT); 3 lb. (kybd)

Shipping 23.5 lb. (CRT); 3.5 lb. (kybd)

Environmental requirements

Ventilation 4 inches minimum on all sides

Temperature Operating: 32 degrees F (0 degrees C) to 113 degrees F (45 degrees C)
Storage: -40 degrees F (-40 degrees C) to 149 degrees F (65 degrees C)

Relative humidity Operating: 10%-85% noncondensing.
Nonoperating: 10%-85% noncondensing.

Maximum power 25 watts

Option board

Available power	5V	200 mA
(beyond normal	+12V	0 amp
load)	-12V	100 mA

Options 20 mA current loop, RS-422, RS-423 interfaces;
external modem; serial-to-parallel converter;
foreign keycap sets

APPENDIX B CODE AND CHARACTER SETS

Seven-Bit ASCII Character Set
Table B-1

B I T S	7 6 5 4				Column →																																																																																																																														
	3	2	1	0	0 0				0 0 1				0 1 0				0 1 1				1 0 0				1 0 1				1 1 0				1 1 1																																																																																																		
	4	3	2	1	0	1	2	3	4	5	6	7	8	9	10	11	12	13	14	15	16	17	18	19	20	21	22	23	24	25	26	27	28	29	30	31	32	33	34	35	36	37	38	39	40	41	42	43	44	45	46	47	48	49	50	51	52	53	54	55	56	57	58	59	60	61	62	63	64	65	66	67	68	69	70	71	72	73	74	75	76	77	78	79	80	81	82	83	84	85	86	87	88	89	90	91	92	93	94	95	96	97	98	99	100	101	102	103	104	105	106	107	108	109	110	111	112	113	114	115	116	117	118	119	120	121	122	123	124	125	126
0	0	0	0	0	NUL	0000	DLE	201610	SP	403220	0	604830	@	1006440	P	1208050	,	1409660	p	16011270																																																																																																															
0	0	0	1	1	SOH	0001	DC1 (XON)	211711	!	413321	1	614931	A	1016541	Q	1218151	a	1419761	q	16111371																																																																																																															
0	0	1	0	2	STX	0010	DC2	221812	"	423422	2	625032	B	1026642	R	1228252	b	1429862	r	16211472																																																																																																															
0	0	1	1	3	ETX	0011	DC3 (XOFF)	231913	#	433523	3	635133	C	1036743	S	1238353	c	1439963	s	16311573																																																																																																															
0	1	0	0	4	EOT	0100	DC4	242014	\$	443624	4	645234	D	1046844	T	1248454	d	14410064	t	16411674																																																																																																															
0	1	0	1	5	ENQ	0101	NAK	252115	%	453725	5	655335	E	1056945	U	1258555	e	14510165	u	16511775																																																																																																															
0	1	1	0	6	ACK	0110	SYN	262216	&	463826	6	665436	F	1067046	V	1268656	f	14610266	v	16611876																																																																																																															
0	1	1	1	7	BEL	0111	ETB	272317	'	473927	7	675537	G	1077147	W	1278757	g	14710367	w	16711977																																																																																																															
1	0	0	0	8	BS	1000	CAN	302418	(504028	8	705638	H	1107248	X	1308858	h	15010468	x	17012078																																																																																																															
1	0	0	1	9	HT	1001	EM	312519)	514129	9	715739	I	1117349	Y	1318959	i	15110569	y	17112179																																																																																																															
1	0	1	0	A(10)	LF	1210	SUB	32261A	*	52422A	:	72583A	J	112744A	Z	132905A	j	1521066A	z	1721227A																																																																																																															
1	0	1	1	B(11)	VT	1311	ESC	33271B	+	53432B	;	73593B	K	113754B	[133915B	k	1531076B	{	1731237B																																																																																																															
1	1	0	0	C(12)	FF	1412	FS	34281C	,	54442C	<	74603C	L	114764C	\	134925C	l	1541086C		1741247C																																																																																																															
1	1	0	1	D(13)	CR	1513	GS	35291D	-	55452D	=	75613D	M	115774D]	135935D	m	1551096D	}	1751257D																																																																																																															
1	1	1	0	E(14)	SO	1614	RS	36301E	.	56462E	>	76623E	N	116784E	^	136945E	n	1561106E	~	1761267E																																																																																																															
1	1	1	1	F(15)	SI	1715	US	37311F	/	57472F	?	77633F	O	117794F	_	137955F	o	1571116F	DEL	1771277F																																																																																																															

KEY

ESC	33 27 1B	OCTAL DECIMAL HEX
-----	----------------	-------------------------

Eight-Bit Multinational Character Set
Table B-2

BITS	7 6 5 4 3 2 1				Column →		0 0		0 0 1		0 1 0		0 1 1		1 0 0		1 0 1		1 1 0		1 1 1			
	4	3	2	1	↓ Row	8	9	A (10)	B (11)	C (12)	D (13)	E (14)	F (15)											
0	0	0	0	0	0	200 128 80	220 144 90	240 160 A0	0	260 176 B0	À 300 192 C0	— 320 208 D0	à 340 224 E0	— 360 240 F0										
0	0	0	0	1	1	201 129 81	221 145 91	241 161 A1	i 1	261 177 B1	Á 301 193 C1	Ñ 321 209 D1	á 341 225 E1	ñ 361 241 F1										
0	0	1	0	0	2	202 130 82	222 146 92	242 162 A2	ç 2	262 178 B2	Â 302 194 C2	Ò 322 210 D2	â 342 226 E2	ò 362 242 F2										
0	0	1	1	0	3	203 131 83	223 147 93	243 163 A3	£ 3	263 179 B3	Ã 303 195 C3	Ó 323 211 D3	ã 343 227 E3	ó 363 243 F3										
0	1	0	0	0	4	204 132 84	224 148 94	244 164 A4	ˆ 4	264 180 B4	Ä 304 196 C4	Ô 324 212 D4	ä 344 228 E4	ö 364 244 F4										
0	1	0	1	0	5	205 133 85	225 149 95	245 165 A5	¥ 5	265 181 B5	Å 305 197 C5	Õ 325 213 D5	å 345 229 E5	õ 365 245 F5										
0	1	1	0	0	6	206 134 86	226 150 96	246 166 A6	® 6	266 182 B6	Æ 306 198 C6	Ö 326 214 D6	æ 346 230 E6	ö 366 246 F6										
0	1	1	1	0	7	207 135 87	227 151 97	247 167 A7	§ 7	267 183 B7	Ç 307 199 C7	Ø 327 215 D7	ç 347 231 E7	ø 367 247 F7										
1	0	0	0	0	8	210 136 88	230 152 98	250 168 A8	☼ 8	270 184 B8	È 310 200 C8	Ø 330 216 D8	è 350 232 E8	ø 370 248 F8										
1	0	0	1	0	9	211 137 89	231 153 99	251 169 A9	© 9	271 185 B9	É 311 201 C9	Ù 331 217 D9	é 351 233 E9	ù 371 249 F9										
1	0	1	0	0	A (10)	212 138 8A	232 154 9A	252 170 AA	à 10	272 186 BA	Ê 312 202 CA	Ú 332 218 DA	ê 352 234 EA	ú 372 250 FA										
1	0	1	1	0	B (11)	213 139 8B	233 155 9B	253 171 AB	θ 11	273 187 BB	Ë 313 203 CB	Û 333 219 DB	ë 353 235 EB	û 373 251 FB										
1	1	0	0	0	C (12)	214 140 8C	234 156 9C	254 172 AC	π 12	274 188 BC	Ì 314 204 CC	Ü 334 220 DC	ì 354 236 EC	ü 374 252 FC										
1	1	0	1	0	D (13)	215 141 8D	235 157 9D	255 173 AD	μ 13	275 189 BD	Í 315 205 CD	Ý 335 221 DD	í 355 237 ED	ÿ 375 253 FD										
1	1	1	0	0	E (14)	216 142 8E	236 158 9E	256 174 AE	Ω 14	276 190 BE	Î 316 206 CE	· 336 222 DE	î 356 238 EE	ÿ 376 254 FE										
1	1	1	1	0	F (15)	217 143 8F	237 159 9F	257 175 AF	Σ 15	277 191 BF	Ï 317 207 CF	β 337 223 DF	ï 357 239 EF	ÿ 377 255 FF										

KEY

ESC	33 27 1B	OCTAL DECIMAL HEX
-----	----------------	-------------------------

**Seven-Bit IBM Character Set
Table B-3**

BITS	7 6 5 4 3 2 1				0 0		0 0		0 1		0 1		1 0		1 0		1 1		1 1		
	4	3	2	1	0	1	2	3	4	5	6	7									
0 0 0 0	0	0	0	0	0	NUL	0	▶	20	SP	40	0	60	Ⓒ	100	P	120	,	140	p	160
0 0 0 1	1	1	1	1	1	☺	1	◀	21	!	41	1	61	A	101	Q	121	a	141	q	161
0 0 1 0	2	2	2	2	2	☹	2	↕	22	"	42	2	62	B	102	R	122	b	142	r	162
0 0 1 1	3	3	3	3	3	♥	3	!!	23	#	43	3	63	C	103	S	123	c	143	s	163
0 1 0 0	4	4	4	4	4	♦	4	¶	24	\$	44	4	64	D	104	T	124	d	144	t	164
0 1 0 1	5	5	5	5	5	♣	5	¢	25	%	45	5	65	E	105	U	125	e	145	u	165
0 1 1 0	6	6	6	6	6	♠	6	—	26	&	46	6	66	F	106	V	126	f	146	v	166
0 1 1 1	7	7	7	7	7	•	7	↕	27	'	47	7	67	G	107	W	127	g	147	w	167
1 0 0 0	8	8	8	8	8	◼	8	↑	30	(50	8	70	H	110	X	130	h	150	x	170
1 0 0 1	9	9	9	9	9	◯	9	↓	31)	51	9	71	I	111	Y	131	i	151	y	171
1 0 1 0	A (10)	10	A	10	A	◐	10	→	32	*	52	:	72	J	112	Z	132	j	152	z	172
1 0 1 1	B (11)	11	B	11	B	♂	11	←	33	+	53	;	73	K	113	[133	k	153	{	173
1 1 0 0	C (12)	12	C	12	C	♀	12	└	34	,	54	<	74	L	114	\	134	l	154	;	174
1 1 0 1	D (13)	13	D	13	D	🎵	13	↔	35	-	55	=	75	M	115]	135	m	155	}	175
1 1 1 0	E (14)	14	E	14	E	🎶	14	▲	36	.	56	>	76	N	116	^	136	n	156	~	176
1 1 1 1	F (15)	15	F	15	F	☀	15	▼	37	/	57	?	77	O	117	—	137	o	157	△	177

KEY

ESC	33 27 1B	OCTAL DECIMAL HEX
-----	----------------	-------------------------

Eight-Bit IBM Character Set
Table B-4

BITS	8 7 6 5 4 3 2 1				1 0 0 0	1 0 0 1	1 0 1 0	1 0 1 1	1 1 0 0	1 1 0 1	1 1 1 0	1 1 1 1
	4	3	2	1	8	9	A (10)	B (11)	C (12)	D (13)	E (14)	F (15)
	0	0	0	0	0	Ç	É	á	█	000	α	≡
	0	0	0	1	1	ü	æ	í	█	001	β	±
	0	0	1	0	2	é	Æ	ó	█	010	Γ	≥
	0	0	1	1	3	â	ô	ú	█	011	∏	≤
	0	1	0	0	4	ä	ö	ñ	█	100	Σ	∫
	0	1	0	1	5	à	ò	Ñ	█	101	σ	∫
	0	1	1	0	6	ã	û	ä	█	110	μ	÷
	0	1	1	1	7	ç	ù	o	█	111	τ	≈
	1	0	0	0	8	ê	ÿ	ç	█	000	Φ	○
	1	0	0	1	9	ë	ÿ	—	█	001	⊖	●
	1	0	1	0	A(10)	è	Û	—	█	010	Ω	•
	1	0	1	1	B(11)	ÿ	ç	½	█	011	δ	√
	1	1	0	0	C(12)	î	£	¼	█	100	∞	∏
	1	1	0	1	D(13)	ì	¥	ì	█	101	∅	²
	1	1	1	0	E(14)	Ä	ƒ	«	█	110	€	█
	1	1	1	1	F(15)	Å	f	»	█	111	∩	BLANK 'FF'

KEY

ESC	33 27 1B	OCTAL DECIMAL HEX
-----	----------------	-------------------------

Monitor Mode ASCII Control Characters
Table B-5

Control Code	ASCII Character	Hex Value	Character Displayed
CTRL @	NUL	00	N _L
CTRL A	SOH	01	S _H
CTRL B	STX	02	S _X
CTRL C	ETX	03	E _X
CTRL D	EOT	04	E _T
CTRL E	ENQ	05	E _Q
CTRL F	ACK	06	A _K
CTRL G	BEL	07	B _L
CTRL H	BS	08	B _S
CTRL I	HT	09	H _T
CTRL J	LF	0A	L _F
CTRL K	VT	0B	V _T
CTRL L	FF	0C	F _F
CTRL M	CR	0D	C _R
CTRL N	SO	0E	S _O
CTRL O	SI	0F	S _I
CTRL P	DLE	10	D _L
CTRL Q	DC1	11	D ₁
CTRL R	DC 2	12	D ₂
CTRL S	DC 3	13	D ₃
CTRL T	DC 4	14	D ₄
CTRL U	NAK	15	N _K
CTRL V	SYN	16	S _Y
CTRL W	ETB	17	E _B
CTRL X	CAN	18	C _N
CTRL Y	EM	19	E _M
CTRL Z	SUB	1A	S _B
CTRL [ESC	1B	E _C
CTRL \	FS	1C	F _S
CTRL]	GS	1D	G _S
CTRL ^	RS	1E	R _S
CTRL _	US	1F	U _S
DEL	DEL	7F	⌘

ASCII Control Character Abbreviations

Table B-6

NUL	null	FF	form feed	CAN	cancel
SOH	start of heading	CR	carriage return	EM	end of medium
STX	start of text	SO	shift out	SUB	substitute
ETX	end of text	SI	shift in	ESC	escape
EOT	end of transmission	DLE	data link escape	FS	file separator
ENQ	enquiry	DC1	device control 1	GS	group separator
ACK	acknowledge	DC2	device control 2	RS	record separator
BEL	bell	DC3	device control 3	US	unit separator
BS	backspace	DC4	device control 4	SP	space
HT	horizontal tabulation	NAK	negative acknowledge	DEL	delete
LF	linefeed	SYN	synchronous idle		
VT	vertical tabulation	ETB	end of transmission block		

APPENDIX C COMMAND SUMMARIES

The tables in this appendix give the commands of the personality modes in 965 Rev. A firmware.

Table C-1 contains commands of TeleVideo 965 and 955 terminals. The remaining TeleVideo terminals are in Table C-2. These are the 950, 925/905, 910/910+, and 912/920 terminals.

Commands for the WY-60 and WY-50/50+ personalities are in Table C-3, and Table C-4 contains commands for the remaining terminal personalities: VP A2, DG200, ADM 3A/5/31, and Hazeltine 1500.

NOTE: The terminal recognizes **boldfaced** commands only during enhanced compatibility mode (enabled in the General set-up menu).

TeleVideo 965 and 955 Commands
Table C-1

Command	965	955
Cursor home	CTRL ^	CTRL ^
New line	CTRL _	CTRL _
Carriage return	CTRL M	CTRL M
Line feed	CTRL J	CTRL J
Cursor up	CTRL K	CTRL K
Pn times	ESC [Pn A	ESC [Pn A
Cursor down	CTRL V	CTRL V
Pn times	ESC [Pn B	ESC [Pn B
Cursor right	CTRL L	CTRL L
Pn times	ESC [Pn C	ESC [Pn C
Cursor left	CTRL H	CTRL H
Pn times	ESC [Pn D	ESC [Pn D
Reverse line feed	ESC j	ESC j
Address the cursor		
Row, column	ESC = rc	ESC = rc
Row, column 132	ESC = r~c	ESC = r~c
Row, col decimal	ESC [r;c H	ESC [r;c H
Page, row, col.	ESC [r;c f	ESC [r;c f
	ESC - prc	ESC - prc
Read the cursor		
Row, column	ESC ?	ESC ?
Row, col. dec.	ESC [6 n	ESC [6 n
Page, row, col.	ESC /	ESC /
P r c decimal	ESC ? [6 n	ESC ? [6 n
Tab	CTRL I	CTRL I
Field tab	ESC i	ESC i
Back tab	ESC I	ESC I
Set tab stop	ESC 1	ESC 1
Clear cursor tab	ESC 2	ESC 2
Clear all tabs	ESC 3	ESC 3

TeleVideo 965 and 955 Commands
Table C-1 (continued)

Command	965	955
Clear page		
Unprotected	CTRL Z	CTRL Z
to spaces	ESC ;	ESC ;
All to spaces	ESC +	ESC +
Unprotected	ESC :	ESC :
to nulls		
All to nulls	ESC *	ESC *
Unprotected to	ESC ,	ESC ,
w.p. spaces		
Uprot. to char	ESC sp Ps	
Field	CTRL X	CTRL X
Clear column		
To W.P. space	ESC x O	
To nulls	ESC x K	
To char	ESC x N Pc	
Clear box		
Unprot. to char	ESC x F rcPc	
All to char	ESC x H rcPc	
Erase		
Line to spaces	ESC T	ESC T
	ESC [Ps K	ESC [Ps K
Line to nulls	ESC t	ESC t
	ESC x L	
Page to spaces	ESC Y	ESC Y
	ESC [Ps J	ESC [Ps J
Page to nulls	ESC y	ESC y
Insert		
Character	ESC Q	ESC Q
Pn characters	ESC [Pn @	ESC [Pn @
Column of nulls	ESC x M	
Line	ESC E	ESC E
Pn lines	ESC [Pn L	ESC [Pn L

TeleVideo 965 and 955 Commands
Table C-1 (continued)

Command	965	955
Delete		
Character	ESC W	ESC W
Pn characters	ESC [Pn P	ESC [Pn P
Cursor column	ESC x J	
Line	ESC R	ESC R
Pn lines	ESC [Pn M	ESC [Pn M
Page edit mode	ESC N	ESC N
Line edit mode	ESC O	ESC O
Insert mode	ESC q	ESC q
Replace mode	ESC r	ESC r
Line wrap on	ESC [= 7 h	ESC [= 7 h
Line wrap off	ESC [= 7 l	ESC [= 7 l
New line mode on	ESC [= 6 h	ESC [= 6 h
New line mode off	ESC [= 6 l	ESC [= 6 l
Enable keyboard	ESC "	ESC "
Disable keyboard	ESC #	ESC #
Keyclick on	ESC >	ESC >
Keyclick off	ESC <	ESC <
Key repeat on	ESC [= 8 h	ESC [= 8 h
Key repeat off	ESC [= 8 l	ESC [= 8 l
CAPS LOCK on	ESC [= 26 h	
CAPS LOCK off	ESC [= 26 l	
Normal CAPS LOCK	ESC [= 25 l	
Reverse CAPS LOCK	ESC [= 25 h	
SETUP enabled	ESC [= 11 h	ESC [= 11 h
SETUP disabled	ESC [= 11 l	ESC [= 11 l
ESC enabled	ESC [= 12 h	ESC [= 12 h
ESC disabled	ESC [= 12 l	ESC [= 12 l
CLR SPC enabled	ESC [= 13 h	ESC [= 13 h
CLR SPC disabled	ESC [= 13 l	ESC [= 13 l
BREAK enabled	ESC [= 14 h	ESC [= 14 h
BREAK disabled	ESC [= 14 l	ESC [= 14 l
Set break signal	ESC 15; Ps v	

TeleVideo 965 and 955 Commands
Table C-1 (continued)

Command	965	955
DOWN = CTRL J	ESC [= 9 h	ESC [= 9 h
DOWN = CTRL V	ESC [= 9 l	ESC [= 9 l
WordStar mode		
on	ESC [= 21 h	
off	ESC [- 21 l	
Application mode		
on	ESC [= 23 h	
off	ESC [= 23 l	
Sound the bell	CTRL G	CTRL G
Margin bell on	ESC [= 4 h	ESC [= 4 h
Margin bell off	ESC [= 4 l	ESC [= 4 l
Set bell col.	CTRL W	CTRL W
Screen saver on	ESC [8;Ps v	ESC [8 ; Ps v
Screen saver off	ESC [8;0 v	ESC [8 ; 0 v
Screen on	ESC n	ESC n
	ESC . 9	
Screen off	ESC o	ESC o
	ESC . 8	
Light background	ESC b	ESC B
Dark background	ESC d	ESC d
Set attribute	ESC G n	ESC G n
Attr. in box	ESC x I hw Pa	
W.P or H.I. on	ESC)	ESC)
W.P or H.I. off	ESC (ESC (
Set W.P. attribute	ESC . Pn	
H.I.		ESC [= 5 l
Normal		ESC [= 5 h
Set information	ESC _ Pn Ps	
line attribute	ESC [3; Ps v	ESC [3 ; Ps v

TeleVideo 965 and 955 Commands
Table C-1 (continued)

Command	965	955
Attribute base		
Character	ESC F 2	ESC F 2
Embedded	ESC F 0	ESC F 0
Nonembedded	ESC F 1	ESC F 1
Line	ESC [= 2 l	ESC [= 2 l
Page	ESC [= 2 h	ESC [= 2 h
Set cursor attr.	ESC . n	ESC . n
Set line attribute	ESC G Ps	ESC G Ps
80-column mode	ESC [= 3 l	ESC [= 3 l
	ESC . :	
132-column mode	ESC [= 3 h	ESC [= 3 h
	ESC . ;	
80-col. econ. on	ESC [= 24 h	
80-col. econ. off	ESC [= 24 l	
Select char set	ESC [9;Ps v	ESC [9; Ps v
Load font banks	ESC x @ Pb Ps	
Clear font banks	ESC x ? Pb	
Auto font load on	ESC [= 29 h	
Auto font load off	ESC [= 29 l	
Set primary set	ESC x B Pb	
Set secondary set	ESC x C Pb	
Display primary set	ESC x D	
Display second. set	ESC x E	
Display character	CTRL U	CTRL U
from secondary set		
Create a soft	ESC x A Pb	
character	B1 ... Bn	
	CTRL Y	
Graphics mode on	ESC \$	ESC \$
Graphics mode off	ESC %	ESC %
Draw a box	ESC H wh	ESC H w h
	ESC x G r c	

TeleVideo 965 and 955 Commands
Table C-1 (continued)

Command	965	955
Protect mode on	ESC &	ESC &
Protect mode off	ESC '	ESC '
Monitor mode on	ESC U	ESC U
Monitor mode off	ESC X	ESC X
	ESC u	ESC u
Set number of data lines	ESC [14;Ps v	
Set number of lines per page	ESC \ Ps	ESC \ Ps
Split the screen	ESC \ C Ps	
Split and clear	ESC \ E Ps	
Split 2 pages	ESC \ A Ps	
Split 2 and clear	ESC \ D Ps	
Activate window		
Upper	ESC \ H	
Lower	ESC \ I	
Raise split line	ESC \ R	
Lower split line	ESC \ P	
Display page		
Next	ESC K	ESC K
Previous	ESC J	ESC J
Pn	ESC [1; Pn }	ESC [1; Pn }
Close the window	ESC \ D	
Close and clear	ESC \ @	
Autoscroll mode		
on	ESC [= 19 h	
off	ESC [= 19 l	
Auto page mode		
on	ESC v	ESC v
off	ESC w	ESC w

TeleVideo 965 and 955 Commands
Table C-1 (continued)

Command	965	955
Jump scroll	ESC 9	ESC 9
Smooth scroll	ESC 8	ESC 8
Set scroll rate	ESC [6; Ps v ESC . Ps	ESC [6; Ps v
Scroll up	ESC [Pn S	ESC [Pn S
Scroll down	ESC [Pn T	ESC [Pn T
Define scrolling region	ESC [t;b r	ESC [t;b r
Line lock on	ESC ! 1 ESC . H	ESC ! 1
Line lock off	ESC ! 2 ESC . I	ESC ! 2
Communication mode		
Block	ESC B	ESC B
Conversational	ESC C	ESC C
FDX	ESC D F	ESC D F
HDX	ESC D H	ESC D H
Local	ESC c	ESC c
Local edit on	ESC k	ESC k
Local edit off	ESC l	ESC l
Set main as host	ESC [= 22 l	
Set aux. as host	ESC [= 22 h	
Set main handshk.		ESC [1;Ps v
Set handshaking		
Main receive	ESC [1;Ps v	
Main transmt	ESC [11;Ps v	
Aux. receive	ESC [12;Ps v	
Aux. transmt	ESC [13;Ps v	
X-On/X-Off on	CTRL O	CTRL O
X-On/X-Off off	CTRL N	CTRL N
Hold host trnsm	CTRL S	CTRL S
Resume host trnsm	CTRL Q	CTRL Q
Transmission control		
mode on	ESC [= 0 h	ESC [= 0 h
mode off	ESC [= 0 l	ESC [= 0 l

TeleVideo 965 and 955 Commands
Table C-1 (continued)

Command	965	955
Configure ports		
Main	ESC { p1 ... p4}	ESC { p1 ... p4
Auxiliary	ESC } p1 ... p4}	ESC } p1 ... p4
7 data bits	ESC [= 1 l	ESC [= 1 l
8 data bits	ESC [= 1 h	ESC [= 1 h
Set receive buffer fill limit	ESC [2;Ps v	ESC [2;Ps v
Set transmit delay rate	ESC [0;Ps v	ESC [0;Ps v
ACK mode on	ESC [= 28 h	
ACK mode off	ESC [= 28 l	
Send/print block boundaries		
From screen top	ESC [= 17 h	
From page top	ESC [= 17 l	
End of display	ESC [= 18 h	
End at cursor	ESC [= 18 l	
Send		
Unprot. line	ESC 4	ESC 4
Unprot. page	ESC 5	ESC 5
Entire line	ESC 6	ESC 6
Entire page	ESC 7	ESC 7
Unprot. message	ESC S	ESC S
Entire message	ESC s	ESC s
One character		
Msg line 1	ESC Z 0	ESC Z 0
Msg line 2	ESC Z 2	ESC Z 2
Status line	ESC Z 1	ESC Z 1
Terminal ID	ESC M	ESC M
Answerback	CTRL E	CTRL E

TeleVideo 965 and 955 Commands
Table C-1 (continued)

Command	965	955
Print modes		
Copy on	ESC @	ESC @
Copy off	ESC A	ESC A
	CTRL T	CTRL T
Transparent on	ESC ‘	ESC ‘
Transparent off	ESC a	ESC a
Bidir. on	CTRL R	CTRL R
Bidir. off	CTRL T	CTRL T
Sec. rec. on	ESC [= 27 h	
Sec. rec. off	ESC [= 27 l	
Page print		
Formatted	ESC P	ESC P
All	ESC [0;0 i	ESC [0;0 i
Unprotected	ESC [0;1 i	ESC [0;1 i
Unformatted	ESC L	ESC L
All	ESC [0;4 i	ESC [0;4 i
Unprotected	ESC [0;5 i	ESC [0;5 i
Page print flip on	ESC [= 15 h	ESC [= 15 h
Page print flip off	ESC [= 15 l	ESC [= 15 l
Select F key set	ESC [7;Ps v	ESC [7;Ps v
Load function	ESC	ESC
key	p1 p2 <msg>	p1 p2 <msg>
	CTRL Y	CTRL Y
F key save on	ESC [= 10 h	ESC [= 10 h
F key save off	ESC [= 10 l	ESC [= 10 l
Send F key msg	ESC [Pn	ESC [Pn
Load editing	ESC 0 Ps	ESC 0 Ps
key	p1 ... p5	p1 p2 p3
Load all editing	ESC] Ps	ESC] Ps
keys	p1 ... p60	p1 ... p60

TeleVideo 965 and 955 Commands
Table C-1 (continued)

Command	965	955
Load replace char Program	ESC e Ps ESC ^	ESC e Ps ESC ^
answerback message	<msg> CTRL Y	<msg> CTRL Y
Reprog. send delimiters	ESC x Ps p1 p2	ESC x Ps p1 p2
Reprog. print terminator	ESC p Ps	ESC p Ps
Display user one on bottom line	ESC g	ESC g
Hide bottom line	ESC h	ESC h
Display status ln on top line	ESC . b	
Turn off top line	ESC . c	
Set top line	ESC 4;Ps v	ESC 4;Ps v
Set bottom line	ESC 5;Ps v	ESC 5;Ps v
Load 25th line	ESC f <msg> CTRL Y	ESC f <msg> CTRL Y
Load user message	ESC _ p1 p2 <msg> CTRL M	ESC _ p1 p2 <msg> CTRL M
Load/display F key labels	ESC _ Ps <msg> CTRL M	
Load time of day	ESC x 8 hh mm	
Enhanced mode on	ESC = 20 h	
Enhanced mode off	ESC = 20 l	
Reset terminal	ESC ~ Pn	ESC ~ Pn
Save set-up values	ESC [0;1 }	ESC [0;1 }
Self test	ESC V	ESC V
Go to user ROM		ESC z

TeleVideo 950, 925/905, 912/920, and 910/910+ Commands
Table C-2

Command	950	925/905	912/920	910/910+
Cursor home	CTRL ^	CTRL ^	CTRL ^	CTRL ^
New line	CTRL <u> </u>	CTRL <u> </u>	CTRL <u> </u>	CTRL <u> </u>
Carriage return	CTRL <u>M</u>	CTRL <u>M</u>	CTRL <u>M</u>	CTRL <u>M</u>
Line feed	CTRL J	CTRL J	CTRL J	CTRL J
Cursor up	CTRL K	CTRL K	CTRL K	CTRL K
Cursor down	CTRL V	CTRL V	CTRL V	CTRL V
Cursor right	CTRL L	CTRL L	CTRL L	CTRL L
Cursor left	CTRL H	CTRL H	CTRL H	CTRL H
Reverse line feed	ESC j	ESC j	ESC j	ESC j
Address the cursor				
Row, column	ESC = rc	ESC = rc	ESC = rc	ESC = rc
Row				ESC [r
Column				ESC] c
Page, row, col.	ESC - prc	ESC - prc	ESC - prc	
Read the cursor				
Row, column	ESC ?	ESC ?	ESC ?	ESC ?
Page, row, col.	ESC /	ESC /	ESC /	
Tab	CTRL I	CTRL I	CTRL I	CTRL I
Field tab	ESC i	ESC i	ESC i	ESC i
Back tab	ESC 1	ESC 1	ESC 1	ESC 1
Set tab stop	ESC 1	ESC 1	ESC 1	ESC 1
Clear cursor tab	ESC 2	ESC 2	ESC 2	ESC 2
Clear all tabs	ESC 3	ESC 3	ESC 3	ESC 3
Clear				
Unprotected	CTRL Z	CTRL Z	CTRL Z	CTRL Z
to spaces	ESC ;	ESC ;	ESC ;	ESC ;
	ESC +	ESC +		ESC +
All to spaces			ESC +	
Unprotected	ESC :	ESC :	ESC :	ESC :
to nulls				
All to nulls	ESC *	ESC *	ESC *	ESC *
Unprotected to	ESC ,	ESC ,		
w.p. spaces				
Field	CTRL X	CTRL X	CTRL X	CTRL X
Code Summaries		C.12		965 VDT

TeleVideo 950, 925/905, 912/920, and 910/910+ Commands
Table C-2 (continued)

Command	950	925/905	912/920	910/910+
Erase				
Line to spaces	ESC T	ESC T	ESC T	ESC T
Line to nulls	ESC t	ESC t	ESC t	ESC t
Page to spaces	ESC Y	ESC Y	ESC Y	ESC Y
Page to nulls	ESC y	ESC y	ESC y	ESC y
Insert character	ESC Q	ESC Q	ESC Q	ESC Q
Delete character	ESC W	ESC W	ESC W	ESC W
Insert line	ESC E	ESC E	ESC E	ESC E
Delete line	ESC R	ESC R	ESC R	ESC R
Page edit mode	ESC N	ESC N	ESC N	ESC N
Line edit mode	ESC O	ESC O	ESC O	ESC O
Insert mode	ESC q	ESC q		ESC q
Replace mode	ESC r	ESC r		ESC r
Enable keyboard	ESC "	ESC "	ESC "	ESC "
Disable keyboard	ESC #	ESC #	ESC #	ESC #
Keyclick on	ESC >	ESC >		ESC >
Keyclick off	ESC <	ESC <		ESC <
Sound the bell	CTRL G	CTRL G	CTRL G	CTRL G
Screen on	ESC n	ESC n		ESC n
Screen off	ESC o	ESC o		ESC o
Light background	ESC b	ESC b		ESC b
Dark background	ESC d	ESC d		ESC d
Set attribute	ESC G n	ESC G n		ESC G n
Blinking on			ESC ^	
Blank on			ESC _	
Blinking/blank off			ESC q	
Reverse on			ESC j	
Reverse off			ESC k	
Underline on			ESC l	
Underline off			ESC m	

TeleVideo 950, 925/905, 912/920, and 910/910+ Commands
Table C-2 (continued)

Command	950	925/905	912/920	910/910+
W.P. or H.I. on	ESC)	ESC)	ESC)	ESC)
W.P. or H.I. off	ESC (ESC (ESC (ESC (
Set cursor attr.	ESC . n	ESC . n	ESC . n	
Toggle cursor on/off				ESC .
Set line attribute	ESC G n	ESC G n		ESC G n
Protect mode on	ESC &	ESC &	ESC &	ESC &
Protect mode off	ESC '	ESC '	ESC '	ESC '
Display control char				ESC F Pc
Graphics mode on	ESC \$	ESC \$	ESC \$	ESC \$
Graphics mode off	ESC %	ESC %	ESC %	ESC %
Draw a box	ESC H w h	ESC H w h		
Monitor mode on	ESC U	ESC U	ESC U	ESC U
Monitor mode	ESC X	ESC X	ESC X	ESC X
off	ESC u	ESC u	ESC u	ESC u
Set number of lines per page	ESC \ Ps			
Display page				
Next	ESC K	ESC K	ESC K	ESC K
Previous	ESC J	ESC J	ESC J	ESC J
Scroll mode on/off				ESC H
Auto page				
Mode on	ESC v	ESC v	ESC v	ESC v
Mode off	ESC w	ESC w	ESC w	ESC w
Jump scroll	ESC 9	ESC 9	ESC 9	ESC 9
Smooth scroll	ESC 8	ESC 8	ESC 8	ESC 8
Line lock on	ESC ! 1			
Line lock off	ESC ! 2			

TeleVideo 950, 925/905, 912/920, and 910/910+ Commands
Table C-2 (continued)

Command	950	925/905	912/920	910/910+
Communication mode				
Block	ESC B	ESC B	ESC B	ESC B
Conversational	ESC C	ESC C	ESC C	ESC C
FDX	ESC D F	ESC D F		
HDX	ESC D H	ESC D H		
Local	ESC c			
Local edit on	ESC k	ESC k	ESC k	ESC k
Local edit off	ESC l	ESC l	ESC l	ESC l
X-On/X-Off on	CTRL O	CTRL O	CTRL O	CTRL O
X-On/X-Off off	CTRL N	CTRL N	CTRL N	CTRL N
Hold main trnsm	CTRL S	CTRL S	CTRL S	CTRL S
Resume main trnsm	CTRL Q	CTRL Q	CTRL Q	CTRL Q
Configure port				
Main	ESC { p1 ... p4			
Auxiliary	ESC } p1 ... p4			
Send				
Unprot. line	ESC 4	ESC 4	ESC 4	ESC 4
Unprot. page	ESC 5	ESC 5	ESC 5	ESC 5
Entire line	ESC 6	ESC 6	ESC 6	ESC 6
Entire page	ESC 7	ESC 7	ESC 7	ESC 7
Unprot. message	ESC S	ESC S	ESC S	ESC S
Entire message	ESC s	ESC s	ESC s	ESC s
One character				ESC M
Msg line 1	ESC Z 0			
Status line	ESC Z 1			
Terminal ID	ESC M	ESC M	ESC M	
Answerback	CTRL E	CTRL E	CTRL E	CTRL E

TeleVideo 950, 925/905, 912/920, and 910/910+ Commands
Table C-2 (continued)

Command	950	925/905	912/920	910/910+
Print modes				
Copy on	ESC @	ESC @	ESC @	ESC @
Copy off	ESC A	ESC A	ESC A	ESC A
	CTRL T	CTRL T	CTRL T	CTRL T
Transparent on	ESC ‘	ESC ‘	ESC ‘	ESC ‘
				CTRL R
Transparent off	ESC a	ESC a	ESC a	ESC a
				CTRL T
Bidir. on	CTRL R	CTRL R	CTRL R	
Bidir. off	CTRL T	CTRL T	CTRL T	
Page print				
Formatted	ESC P	ESC P	ESC P	ESC P
Unformatted	ESC L	ESC L	ESC L	ESC L
Load function key				
	ESC	ESC	ESC	ESC
	p1 p2	p1 p2	p1 p2	p1 p2
	<msg>	<msg>	<msg>	<msg>
	CTRL Y	CTRL Y	CTRL Y	CTRL Y
Load editing key				
	ESC 0 Ps			
	p1 p2 p3			
Load all editing keys				
	ESC Ps			
	p1 ... p60			
Load replace char				
	ESC e Ps			
Program answerback message				
	ESC ^	ESC ^		
	<msg>	<msg>		
	CTRL Y	CTRL Y		
Reprog. send delimiters				
	ESC x	ESC x		
	Ps p1 p2	Ps p1 p2		
Reprog. print terminator				
	ESC p Ps	ESC p Ps		

TeleVideo 950, 925/905, 912/920, and 910/910+ Commands
Table C-2 (continued)

Command	950	925/905	912/920	910/910+
Display msg. line	ESC g	ESC g		
Display status ln.	ESC h	ESC h		
Load 25th line	ESC f <msg> CTRL Y	ESC f <msg> CTRL Y		
Reset	ESC ~ Pn	ESC ~ Pn	ESC ~ Pn	ESC ~ Pn
Self test	ESC V	ESC V		ESC V
Go to user ROM	ESC z	ESC z		ESC z

WY-60 and WY-50/50+ Commands
Table C-3

Command	WY-60	WY-50/50+
Cursor home	CTRL ^	CTRL ^
	ESC {	ESC {
New line	CTRL <u> </u>	CTRL <u> </u>
Carriage return	CTRL <u>M</u>	CTRL <u>M</u>
Line feed	CTRL J	CTRL J
Cursor up	CTRL K	CTRL K
Cursor down	CTRL V	CTRL V
Cursor right	CTRL L	CTRL L
Cursor left	CTRL H	CTRL H
Reverse line feed	ESC j	ESC j
Address the cursor		
Row, column	ESC = rc	ESC = rc
Row, col decimal	ESC a rc	ESC a rc
Page, row, col.	ESC - prc	ESC - prc
	ESC w @ prc	
Read the cursor		
Row, column	ESC ?	ESC ?
Row, col. dec.	ESC b	ESC b
Page, row, col.	ESC /	ESC /
P r c decimal	ESC w	
Tab	CTRL I	CTRL I
Field tab	ESC i	ESC i
Back tab	ESC I	ESC I
Set tab stop	ESC 1	ESC 1
Clear cursor tab	ESC 2	ESC 2
Clear all tabs	ESC 0	ESC 0

WY-60 and WY-50/50+ Commands
Table C-3 (continued)

Command	WY-60	WY-50/50+
Clear page		
Unprotected	CTRL Z	CTRL Z
to spaces	ESC ;	ESC ;
All to spaces	ESC +	ESC +
Unprotected	ESC :	ESC :
to nulls		
All to nulls	ESC *	ESC *
Unprotected to	ESC ,	ESC ,
w.p. spaces		
Uprot. to char	ESC . Ps	ESC . Ps
Clear column		
To W.P. space	ESC V	ESC V
To nulls	ESC c K	
To char	ESC c I Pc	
Clear box		
Unprot. to char	ESC c F rc Pc	
All to char	ESC c H rc Pc	
Erase		
Line to spaces	ESC T	ESC T
Line to nulls	ESC t	ESC t
	ESC c L	
Page to spaces	ESC Y	ESC Y
Page to nulls	ESC y	ESC y
Insert		
Character	ESC Q	ESC Q
Column of nulls	ESC c M	
Line	ESC E	ESC E
Delete		
Character	ESC W	ESC W
Cursor column	ESC c J	
Line	ESC R	ESC R

WY-60 and WY-50/50+ Commands
Table C-3 (continued)

Command	WY-60	WY-50/50+
Page edit mode	ESC e #	
Line edit mode	ESC e "	
Insert mode	ESC q	ESC q
Replace mode	ESC r	ESC r
Line wrap on	ESC d /	
Line wrap off	ESC d .	
New line mode on	ESC e 5	
New line mode off	ESC e 4	
Enable keyboard	ESC " CTRL N	ESC " CTRL N
Disable keyboard	ESC # CTRL O	ESC # CTRL O
Keyclick on	ESC e %	
Keyclick off	ESC e \$	
Key repeat on	ESC e -	
Key repeat off	ESC e ,	
CAPS LOCK on	ESC e &	
CAPS LOCK off	ESC e '	
Normal CAPS LOCK	ESC e U	
Reverse CAPS LOCK	ESC e V	
WordStar mode		
on	ESC ~ /	
off	ESC ~ .	
Application mode		
on	ESC ~ 3	
off	ESC ~ 2	
Sound the bell	CTRL G	CTRL G
Screen saver on	ESC e Q	
Screen saver off	ESC e P	
Screen on	ESC ' 9	ESC ' 9
Screen off	ESC ' 8	ESC ' 8
Light background	ESC A 04	ESC A 04
Dark background	ESC A 00	ESC A 00

WY-60 and WY-50/50+ Commands
Table C-3 (continued)

Command	WY-60	WY-50/50+
Set attribute	ESC G n	ESC G n
W.P or H.I. on	ESC)	ESC)
W.P or H.I. off	ESC (ESC (
Set W.P. attribute	ESC ' Pn	ESC ' Pn
Set information line attribute	ESC A Pn Ps	ESC A Pn Ps
Attribute base		
Character	ESC e 0	
Nonembedded	ESC e 1	
Line	ESC e 3	
Page	ESC e 2	
Set cursor attr.	ESC ' n	ESC ' n
Set line attribute	ESC G Ps	
80-column mode	ESC ' :	ESC ' :
132-column mode	ESC ' ;	ESC ' ;
80-col. econ. on	ESC e G	
80-col. econ. off	ESC e F	
Auto font load on	ESC e O	
Auto font load off	ESC e N	
Graphics mode on	ESC H Ps	ESC H Ps
Graphics mode off	ESC H Ps	ESC H Ps
Draw a box	ESC c G rc	
Protect mode on	ESC &	ESC &
Protect mode off	ESC '	ESC '
Monitor mode on	ESC U	ESC U
Monitor mode off	ESC X ESC u	ESC X ESC u
Set number of data lines	ESC e Ps	
Set number of lines per page	ESC w Ps	

WY-60 and WY-50/50+ Commands
Table C-3 (continued)

Command	WY-60	WY-50/50+
Split the screen	ESC x C P/	ESC x C P/
Split and clear	ESC x 3 P/	ESC x 3 P/
Split 2 pages	ESC x A P/	ESC x A P/
Split 2 and clear	ESC x 1 P/	ESC x 1 P/
Activate window		
Upper	ESC]	ESC]
Lower	ESC }	ESC }
Raise split line	ESC x R	ESC x R
Lower split line	ESC x P	ESC x P
Display page		
Next	ESC K	ESC K
Previous	ESC J	ESC J
Pn	ESC w Pn	ESC w Pn
Close the window	ESC x @	ESC x @
Close and clear	ESC x 0	ESC x 0
Autoscroll mode		
on	ESC O	ESC O
off	ESC N	ESC N
Auto page mode		
on	ESC d +	ESC d +
off	ESC d *	ESC d *
Jump scroll	ESC ' @	ESC ' @
Smooth scroll	ESC ' =	ESC ' =
Set scroll rate	ESC ' Ps	ESC ' Ps
Line lock on	ESC ' H	ESC ' H
Line lock off	ESC ' I	ESC ' I

WY-60 and WY-50/50+ Commands
Table C-3 (continued)

Command	WY-60	WY-50/50+
Communication mode		
Block	ESC B	ESC B
Conversational	ESC C	ESC C
FDX	ESC D F	ESC D F
HDX	ESC D H	ESC D H
Local		
Local edit on	ESC k	ESC k
Local edit off	ESC l	ESC l
Set main as host	ESC e 8	
Set aux. as host	ESC e 9	
Set handshaking		
Main receive	ESC c 2 n	
Main transmt	ESC c 4 n	
Aux. receive	ESC c 3 n	
Aux. transmt	ESC c 5 n	
Hold host trnsm	CTRL S	CTRL S
Resume host trnsm	CTRL Q	CTRL Q
Configure ports		
Main	ESC c 0	
Auxiliary	ESC c 1	
Set transmit delay rate	ESC c 6 n	
ACK mode on	ESC e 7	
ACK mode off	ESC e 6	
Send/print block boundaries		
From screen top	ESC d '	
From page top	ESC d &	
End of pg/ln	ESC e E	
End at cursor	ESC e D	

WY-60 and WY-50/50+ Commands
Table C-3 (continued)

Command	WY-60	WY-50/50+
Send		
Unprot. line	ESC 4	ESC 4
Unprot. page	ESC 5	ESC 5
Entire line	ESC 6	ESC 6
Entire page	ESC 7	ESC 7
Unprot. message	ESC S	ESC S
Entire message	ESC s	ESC s
One character	ESC M	
Terminal ID	ESC sp	
Answerback	CTRL E	CTRL E
Print modes		
Copy on	CTRL R	CTRL R
Copy off	CTRL T	CTRL T
Transparent on	ESC d #	
	CTRL X	
Transparent off	CTRL T	
Bidir. on	ESC d %	
Bidir. off	ESC d \$	
Sec. rec. on	ESC d !	
Sec. rec. off	ESC d sp	
Page print		
Formatted	ESC P	ESC P
Unprotected	ESC @	ESC @
Unformatted	ESC L	ESC L
	ESC p	ESC p
Load function		
key	ESC z	ESC z
	p1 p2	n
	<msg>	<msg>
	DEL	DEL
Load editing		
key	ESC Z	
	p1 p2	
	<msg> DEL	

WY-60 and WY-50/50+ Commands
Table C-3 (continued)

Command	WY-60
Set status line	ESC ' Ps
Load user message	ESC F <msg>
Load/display F key labels	CTRL M ESC z Ps <msg>
Load time of day	CTRL M ESC c 8 hh mm
Enhanced mode on	ESC ~ !
Enhanced mode off	ESC ~ sp
Reset terminal	ESC ! Pn
Save set-up values	ESC ! 2

VP A2, DG200, ADM, and HZ 1500 Commands

Table C-4

Command	VP A2	DG200	ADM3A/ 5/31	HZ 1500
Cursor home	CTRL A	CTRL H	CTRL ^	~CTRL R
New line		CTRL J	CTRL _	
Carriage return	CTRL M	CTRL M	CTRL M	CTRL M
Line feed	CTRL J		CTRL J	CTRL J
Cursor up	CTRL Z	CTRL W	CTRL K	~CTRL L
Cursor down		CTRL Z		~CTRL K
Cursor right	CTRL F	CTRL X	CTRL L	CTRL P
Cursor left	CTRL U	CTRL Y	CTRL H	CTRL H
Address the cursor				
Row, column	ESC Y rc		ESC = rc	
Column, row		CTRL P cr		~CTRL Q cr
Row, column 132			ESC = r~c	
Row	CTRL K r			
Column	CTRL P c			
Page, row, col.			ESC - prc	
Read the cursor				
Row, column		CTRL E	ESC ?	~CTRL E
Page, row, col.			ESC /	
Tab	CTRL I		CTRL I	CTRL I
Field tab			ESC i	CTRL I
Back tab	ESC O		ESC I	~CTRL I
Clear page				
Unprotected to spaces			CTRL Z	~CTRL J
All to spaces	CTRL L	CTRL L	ESC ;	
Unprotected to nulls			ESC +	~CTRL \
All to nulls			ESC :	
Unprotected to w.p. spaces			ESC *	
			ESC ,	

VP A2, DG200, ADM, and HZ 1500 Commands
Table C-4 (continued)

Command	VP A2	DG200	ADM3A/ 5/31	HZ 1500
Erase				
Line to spaces	ESC K	CTRL K	ESC T	~CTRL O
Line to nulls			ESC t	
Page to spaces	ESC k ESC J	RS F	ESC Y	~CTRL X
Page to W.P space				~CTRL W
Page to nulls			ESC y	
Insert				
Character	ESC F		ESC Q	
Line	ESC M		ESC E	~CTRL Z
Pn lines	ESC [Pn L			
Delete				
Character	ESC E		ESC W	
Line	ESC /		ESC R	~CTRL S
Insert mode				
Replace mode			ESC q ESC r	
Enable keyboard				
	ESC 6 CTRL B		ESC " CTRL N	~CTRL F
Disable keyboard				
	ESC 5 CTRL D		ESC # CTRL O	~CTRL U
Sound the bell	CTRL G	CTRL G	CTRL G	CTRL G
Screen on				
Screen off	ESC d ESC D			
Set attribute				
Tag bit set	ESC 0 n CTRL N		ESC G n	~CTRL G n
Tag bit reset	CTRL O			

VP A2, DG200, ADM, and HZ 1500 Commands
Table C-4 (continued)

Command	VP A2	DG200	ADM3A/ 5/31	HZ 1500
Blinking on		CTRL N		
Blinking off		CTRL O		
Reverse on		RS D		
Reverse off		RS E		
Underline on		CTRL T		
Underline off		CTRL U		
W.P or H.I. on	CTRL N	CTRL \	ESC)	~CTRL Y
W.P or H.I. off	CTRL O	CTRL]	ESC (~CTRL _
Cursor on	CTRL X			
Cursor off	CTRL W			
Graphics mode on	ESC 1			
Graphics mode off	ESC 2			
Autoscroll mode				
on		CTRL R		
off		CTRL S		
Display page				
Next			ESC K	
Previous			ESC J	
Auto page				
Mode on			ESC v	
Mode off			ESC w	
Communication mode				
Block	ESC t		ESC B	
Conversational	ESC T		ESC C	
FDX			ESC D F	
HDX			ESC D H	
Hold host trnsm	CTRL S			
Resume host trnsm	CTRL Q			

VP A2, DG200, ADM, and HZ 1500 Commands
Table C-4 (continued)

Command	VP A2	DG200	ADM3A/ 5/31	HZ 1500
Send				
Unprot. line			ESC 4	
Unprot. page			ESC 5	
Entire line			ESC 6	
Entire page			ESC 7	
Unprot. message			ESC S	
Entire message	ESC s			
One character				~CTRL T
Terminal ID		RS C		
Answerback			CTRL E	
Print modes				
Copy on	CTRL R	RS ETX	CTRL R ESC A 2	CTRL R
Copy off	CTRL T	RS STX	CTRL T	CTRL T ESC A 0
Transparent on	ESC 3	RS SOH	ESC A 1	ESC *
Transparent off	ESC 4	RS STX	CTRL T	ESC /
Line print all		CTRL Q		
Line print unprot.		CTRL A		
Page print				
Formatted	ESC X		ESC P	
Unprotected			ESC @	
Unformatted	ESC x		ESC L	
Display msg. line	ESC B		ESC {	~CTRL N
Display status ln.	ESC b		ESC }	~CTRL P
Load function key	ESC p1 p2 <msg> CTRL Y		ESC p1 p2 <msg> CTRL Y	
Load replace char			ESC . 8 m	
Reprog. send delimiters			ESC . n m	

APPENDIX D KEY CODES

Native Mode Key Codes Table D-1

A. Editing Keys

Key	Code	
	Alone	Shifted
HOME	CTRL ^	CTRL ^
DOWN	CTRL V	CTRL J
UP	CTRL K	ESC j
RIGHT	CTRL L	CTRL L
LEFT	CTRL H	CTRL H
BACK SPACE	CTRL H	CTRL H
TAB (main)	CTRL I	ESC I
LINE FEED	CTRL J	CTRL J
ENTER	CTRL M	CTRL M
RETURN	CTRL M	CTRL M
CLEAR SPACE	CTRL Z	ESC *
CE	CTRL X	ESC 0
CHAR INSERT	ESC Q	ESC Q
CHAR DELETE	ESC W	ESC W
LINE INSERT	ESC E	ESC E
LINE DELETE	ESC R	ESC R
LINE ERASE	ESC T	ESC t
PAGE ERASE	ESC Y	ESC y
TAB (kypad)	CTRL I	CTRL I
SEND	ESC 7	ESC 6
PRINT	ESC P	ESC L
PAGE	ESC K	ESC J

**Native Mode Key Codes
Table D-1 (continued)**

B. Function Key Codes

Key	Set One		Set Two	
	Alone	Shifted	Alone	Shifted
F1	SOH @ CR	SOH ' CR	SOH P CR	SOH p CR
F2	SOH A CR	SOH a CR	SOH Q CR	SOH q CR
F3	SOH B CR	SOH b CR	SOH R CR	SOH r CR
F4	SOH C CR	SOH c CR	SOH S CR	SOH s CR
F5	SOH D CR	SOH d CR	SOH T CR	SOH t CR
F6	SOH E CR	SOH e CR	SOH U CR	SOH u CR
F7	SOH F CR	SOH f CR	SOH V CR	SOH v CR
F8	SOH G CR	SOH g CR	SOH W CR	SOH w CR
F9	SOH H CR	SOH h CR	SOH X CR	SOH x CR
F10	SOH I CR	SOH i CR	SOH Y CR	SOH y CR
F11	SOH J CR	SOH j CR	SOH Z CR	SOH z CR
F12	SOH K CR	SOH k CR	SOH [CR	SOH { CR
F13	SOH L CR	SOH l CR	SOH \ CR	SOH CR
F14	SOH M CR	SOH m CR	SOH] CR	SOH } CR
F15	SOH N CR	SOH n CR	SOH ^ CR	SOH ~ CR
F16	SOH O CR	SOH o CR	SOH _ CR	SOH ☐ CR

Application Mode Key Codes
Table D-2

A. Editing and Special Keys

Key	Hex Code	
	Unshifted	Shifted
LEFT	88	80
TAB (main)	89	81
DOWN	8A	82
UP	8B	83
RIGHT	8C	84
RETURN	8D	85
HOME	8E	86
BACK SPACE	8F	87
LINE FEED	90	A0
PRINT	92	A2
CLEAR SPACE	93	A3
CHAR INSERT	94	A4
CHAR DELETE	95	A5
LINE INSERT	96	A6
LINE DELETE	97	A7
LINE ERASE	98	A8
PAGE ERASE	99	A9
PAGE	9A	AA
ESC	F0	F1
SEND	F2	F3
ENTER	F4	F5
TAB (kypad)	F6	F7
CE	F8	F9
BREAK	FB	FC
NO SCROLL	FD	--

Application Mode Key Codes
Table D-2 (continued)

B. Function Keys

Key	Hex Code	
	Unshifted	Shifted
F1	D0	E0
F2	D1	E1
F3	D2	E2
F4	D3	E3
F5	D4	E4
F6	D5	E5
F7	D6	E6
F8	D7	E7
F9	D8	E8
F10	D9	E9
F11	DA	EA
F12	DB	EB
F13	DC	EC
F14	DD	ED
F15	DE	EE
F16	DF	EF

C. Numeric Keypad Keys

Key	Hex Code
0	B0
1	B1
2	B2
3	B3
4	B4
5	B5
6	B6
7	B7
8	B8
9	B9
,	BC
-	BD
.	BE
00	FA

WordStar Mode Key Codes
Table D-3

Key	Command	
	Unshifted	Shifted
HOME	^QE Top of screen	^QR Beginning of file
DOWN	^X Down line	^Z Up line
UP	^E Up line	^W Down line
LEFT	^S Left character	^A Left word
RIGHT	^D Right character	^F Right word
TAB (main)	^I Tab right	^QB Block beginning
TAB (kypad)	^I Tab right	^QK Block end
PAGE	^C Up screenful	^R Down screenful
CLEAR	^QX Bottom of screen	^QC End of file
CHAR INSERT	^V Insert on/off	^QP Previous position
CHAR DELETE	^G Delete character	^T Delete word right
LINE INSERT	^N Carriage return	^KH Hide/display block
LINE DELETE	^Y Delete line	^KV Move block
LINE ERASE	^QY Delete to end of line	^Q DEL Delete to beg. of line
PAGE ERASE	^KY Delete block	^KC Copy block
CE	^U Interrupt	^KJ Delete file
PRINT	^PB Boldface beg./end	^PS Underscore beg./end
SEND	^KW Write block to file	^KR Read file into text
F1	^OL Left margin set	^OR Right margin set
F2	^OI Tab set	^ON Tab clear
F3	^B Reform paragraph	^OC Center line
F4	^OS Line space setting	^OG Paragraph tab
F5	^KB Mark block beg.	^KK Mark block end
F6	^QF Find string	^QA Find & replace
F7	^L Find/replace again	^QV Start of last find/replace
F8	^JH Set help level	^QQ Repeat next command
F9	^QZ Continuous up scroll	^QW Continuous down scroll
F10	.IIE Heading	.FO Footing
F11	.PA New page	^PD Double strike beg./end
F12	^PV Subscript beg./end	^PT Superscript beg./end
F13	^OJ Justification on/off	^OW Word wrap on/off
F14	^K Block menu	^Q Quick menu
F15	^KD Save, done edit	^KX Save, exit to system
F16	^KS Save and resume	^KQ Abandon edit

APPENDIX E INTERNATIONAL KEYBOARDS

U.K. Keyboard Layout

Figure E-1

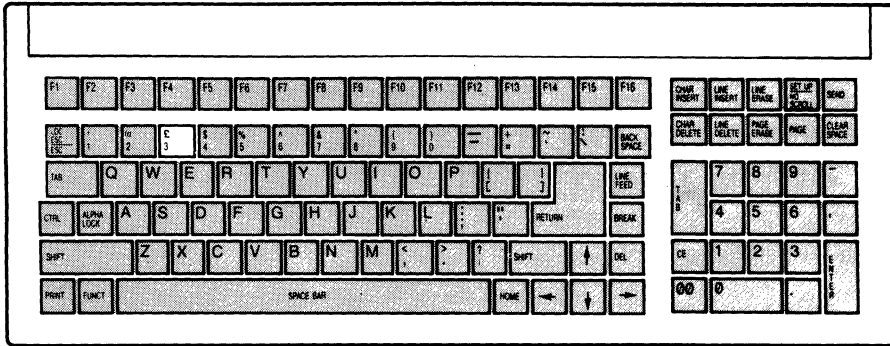

French Keyboard Layout

Figure E-2

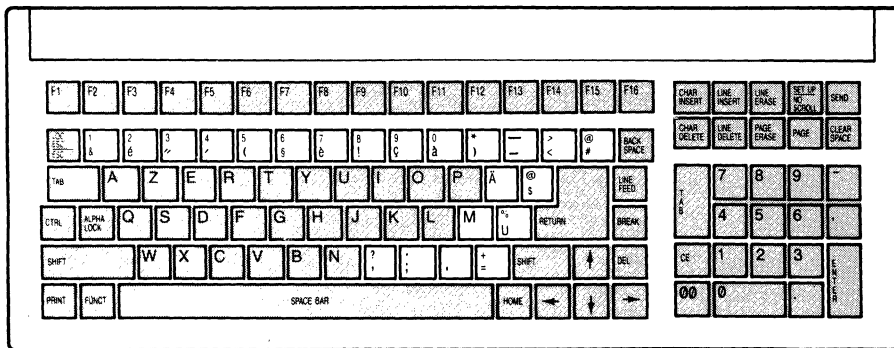

**German Keyboard Layout
Figure E-3**

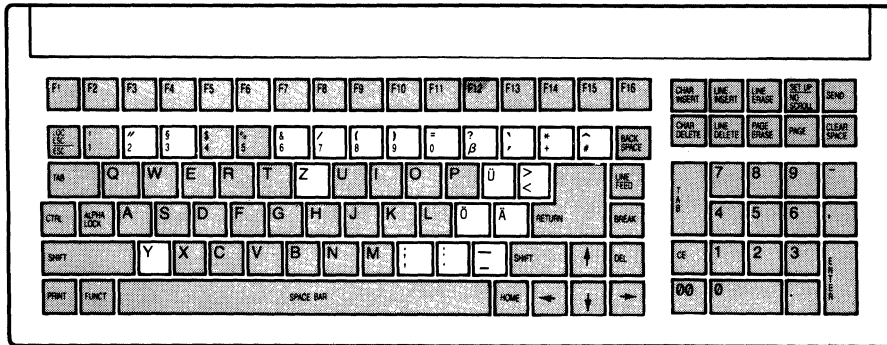

**Swedish Keyboard Layout
Figure E-4**

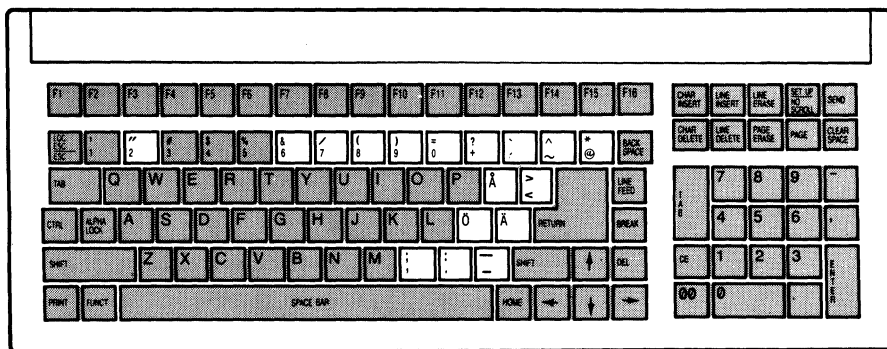

**Norwegian Keyboard Layout
Figure E-5**

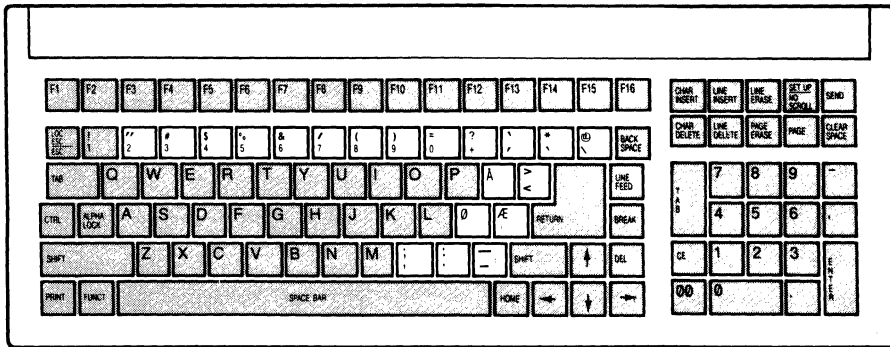

**Finnish Keyboard Layout
Figure E-6**

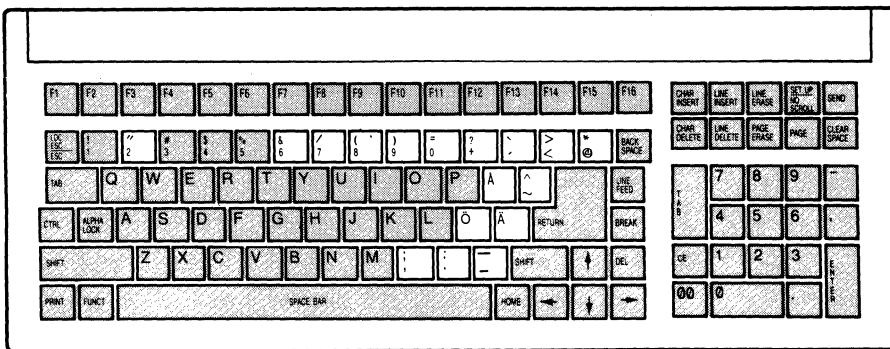

APPENDIX F CURSOR COORDINATES

Row/ Column	ASCII Code Transmitted	Row/ Column	ASCII Code Transmitted	Row/ Column	ASCII Code Transmitted	Row/ Column	ASCII Code Transmitted
1	Space	28	;	55	V	82	q
2	!	29	<	56	W	83	r
3	"	30	=	57	X	84	s
4	#	31	>	58	Y	85	t
5	\$	32	?	59	Z	86	u
6	%	33	@	60	[87	v
7	&	34	A	61	\	88	w
8	'	35	B	62]	89	x
9	(36	C	63	^	90	y
10)	37	D	64	_	91	z
11	*	38	E	65	`	92	{
12	+	39	F	66	a	93	
13	,	40	G	67	b	94	}
14	-	41	H	68	c	95	~
15	.	42	I	69	d	96	DEL
16	/	43	J	70	e		
17	0	44	K	71	f		
18	1	45	L	72	g		
19	2	46	M	73	h		
20	3	47	N	74	i		
21	4	48	O	75	j		
22	5	49	P	76	k		
23	6	50	Q	77	l		
24	7	51	R	78	m		
25	8	52	S	79	n		
26	9	53	T	80	o		
27	:	54	U	81	p		

APPENDIX G STATUS LINE MESSAGES

Field	Values	Description
1	p rrr ccc	P = Page of memory (0-6) R = Row (1-168) C = Column (1-132)
2	*	Monitor mode on/off (blank)
	w	WordStar mode on/off (blank)
	mode	Communication mode: FDX = full duplex HDX = half duplex BLK = block LOC = local
3	W.P.	Write protect mode on/off (blank)
4	PROT	Protect mode on/off (blank)
5	CAP	CAPS LOCK key engaged/released (blank)
6	GRAF	Graphics mode on/off (blank)
7	blank	
8	mode	Print mode or operation: UFPG = Unformatted page print FMPG = Formatted page print TRSP = Transparent mode COPY = Copy mode BDIR = Bidirectional mode
	SEND	Block send in progress
	HOLD	NO SCROLL key engaged (screen updating halted)



1170 Morse Avenue
P.O. Box 3568
Sunnyvale, CA 94088-3568