

LOGIC ANALYZERS

PM3551/10/30/50/70

Operating manual

9499 500 12211

8304028

This manual covers software release 1.1



PHILIPS

LOGIC ANALYZERS

PM3551/10/30/50/70

Operating manual

9499 500 12211
8304028

This manual covers software release 1.1



PHILIPS

A publication of the Scientific and Industrial Equipment Division.
PHILIPS EXPORT B.V. - EINDHOVEN - THE NETHERLANDS - 1983
Printed in the Netherlands.

April 28, 1983

TABLE OF CONTENTS

<u>Section</u>	<u>Description</u>	<u>Page</u>
1	INTRODUCTION	1.4
1.1	General information.	1.4
1.2	Features	1.5
2	CHARACTERISTICS.	2.1
2.1	Logic State analyzer	2.4
2.2	Logic Timing analyzer.	2.9
2.3	Operation.	2.11
2.4	Display.	2.11
2.5	Display modes.	2.12
2.6	Compare mode	2.13
2.7	Power supply	2.13
2.8	Environmental characteristics.	2.14
2.9	Physical characteristics	2.16
2.10	Accessories and Options	2.17
3	GENERAL DIRECTIONS	3.1
3.1	Information and Warnings for the User.	3.2
3.2	Description of controls, connectors and display.	3.6
3.2.1	Front panel.	3.6
3.2.2	Rear panel.	3.9
4	DESCRIPTION OF THE MENUS	4.1
4.1	Full menus	4.3
4.1.1	Configuration menu	4.3
4.1.2	Trigger menu	4.7
4.1.3	Data menu.	4.17
4.1.4	Compare menu	4.21
4.1.5	Options menu	4.27
4.2	Condensed menus.	4.32
5	DESCRIPTION OF THE DATA DISPLAYS	5.1
5.1	List	5.3
5.1.1	Selective data	5.7
5.1.2	Compare data	5.8
5.2	Graph.	5.9
5.3	Timing	5.12
5.3.1	Timing compare	5.15
5.4	Sync mode.	5.16
6	CONNECTION	6.1
6.1	Input.	6.2
6.2	What else to connect?.	6.3
7	USER MESSAGE LIST.	7.1
8	OPERATION.	8.1
8.1	General.	8.2
8.2	Triggering	8.2
8.3	Selective data acquisition	8.4
8.4	Compare.	8.4

->

TABLE OF CONTENTS (cont'd)

<u>Section</u>	<u>Description</u>	<u>Page</u>
9	INTERFACE AND OPTIONS.	9.1
9.1	Printer Interface.	9.2
9.2	Disassemblers General.	9.4
9.2.1	Disassemblers Accesories	9.5
9.2.2	Non-volatile memory.	9.7
9.3	Disassembler connection and display.	9.10
9.3.1	A Package.	9.11
9.3.2	M Package.	9.18
10	INSTALLATION INSTRUCTIONS FOR OPTIONS.	10.1
10.1	Unit identifier switch	10.3
10.2	Additional 24-channel state analyzer	10.4
10.3	8-channel 50 MHz timing analyzer	10.5
10.4	Option board, disa's and non-volatile memory	10.10
11	PROBLEM REPORTS AND CHANGE REQUESTS.	11.1

1

I N T R O D U C T I O N

April 20, 1983

1. INTRODUCTION

1.1. GENERAL INFORMATION

The Philips PM3551 Logic Analyzer family comprises 4 models: PM3551/10, PM3551/30, PM3551/50 and PM3551/70, with each model containing features suitable for a variety of application needs.

This manual contains information to operate the whole range of models.

The PM3551/30 and PM3551/70 models are compact instruments whose easy-to-operate design offers the user a very comprehensive selection of Time, Data and Graph analysis features. The extensive measurement capabilities will enable the user to test and troubleshoot a wide range of digital systems, with the additional plus factor that the instruments are extremely well suited for use in a teaching environment.

The PM3551/70 model is capable of recording a maximum of 59 state channels and 8 50MHz timing channels while the PM3551/30 although identical in design and operation is capable of measuring a maximum of 35 state channels and 8 50MHz timing channels.

The PM3551/10 and PM3551/50 models have the same features as the above mentioned PM3551/30 and PM3551/70 models with the exception of the "50MHz Timing Analyzer" mode.

The operator control panel is divided into several functional areas which guide and help the user to set up the most effective test procedure.

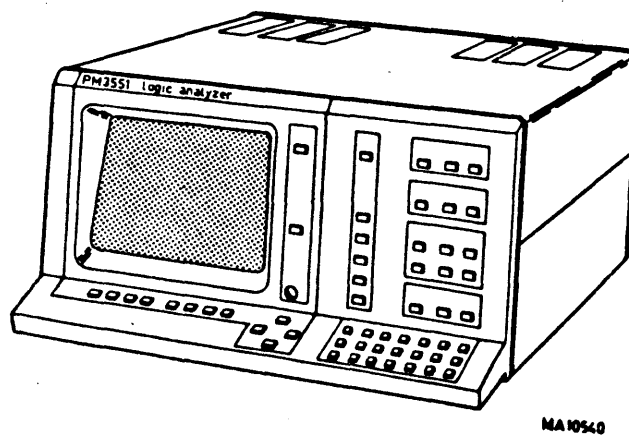

Fig.1.1. Logic Analyzer PM3551

1.2. FEATURES

A functionally organized keyboard/softkey structure in combination with an interactive menu-display serve the user in setting up and entering parameters for triggering, capturing, comparing and counting the activities of the system under test.

The extensive triggering capability of the 7 sequential trigger-words, that can be combined with clock and trigger-qualifiers, permits capturing data from complex system activities or from deep branched or nested loops. Each trigger-word has the same width as the number of input channels of the various models.

The sequence of the different trigger-words used can be defined by the use of an IF, THEN, ELSE algorithm, with the possibility of placing a certain amount of delay between the statements.

In this mode, triggering can be selected as True or False.

A notable feature of this mode is that the selected trigger sequence can be specified as true or alternatively as not true. This latter mode is called "Trigger on Sequence Break" mode and provides the capability of triggering when a defined repetitive pattern (eg. a loop or a polling sequence) is broken or not executed in the specified order.

The moment of capturing data can be delayed by states and/or trigger occurrences and/or time.

The Logic Analyzer can also be used for making time measurements. A readout of the elapsed time between two points in a program can be obtained.

Special features of note here are the COMBI and the SYNC modes.

The COMBI mode allows the state section to be triggered by the timing section or vice-versa, while in the SYNC mode the displays of a number of timing channels are cross-referenced with state sampling. This enables analysis of critical state/time relationships.

Data to be captured is clocked into the analyzer on selected clock edges of one of the three selectable clock sources. For each clock used, there are up to four qualifiers available.

In the COMPARE mode, a comparison can be made between captured data and stored data in the formats: List or Timing.

The instrument automatically stores the current mode- and function setting, when the mains voltage supply is switched off. After switching on, the instrument comes up in the initial default mode- and function setting.

All analyzer models can be equipped with the option to store up to 4 additional settings. Here each setting is stored and retrieved by a code, entered through the keyboard.

In the TIMING mode, glitches of a duration of as little as 5 nanoseconds can be captured from the data-stream.

When powering up the analyzer, a self-test routine is automatically initiated. If a fault is encountered during this self-test, an appropriate diagnostic message will be displayed.

The PM 3551 can be equipped with a 4 channel 300MHz timing option, independently of the presence of the 8 channel 50 MHz section. This allows high precision timing measurements.

Other options are the RS232-C Serial interface which enables connection of a printer or cassette, the IEEE 488 Parallel interface and the Disassembly packages. One interface can be installed, and it is a prerequisite for installation of a Disassembly option. The Disassembly (Disa) option allows the user to view captured data in the mnemonic language of the most currently available 8 and 16-bit microprocessors.

Data is entered into the analyzer via 8-channel pods, each provided with its own threshold adjustment. A variety of convenient pod attachments are available for connecting the system under test to the analyzer.

C H A R A C T E R I S T I C S

2. CHARACTERISTICS

The instrument has been designed and tested according to IEC Publication 348 for Class I instruments and has been supplied in a safe condition. The present Operating Manual contains information and warnings which should be followed by the purchaser to ensure safe operation and to maintain the instrument in a safe condition.

Properties expressed in numerical values with stated tolerances are guaranteed for ambient temperatures of +5 deg.C ... +40 deg.C unless stated otherwise. Numerical values without tolerances are typical and represent the characteristics of an average instrument. This specification is valid after the instrument has warmed up for 15 minutes.

OPERATION MODES:

- Logic State Analyzer only
- Logic Timing Analyzer only
- Combi Mode where the LSA can enable the triggering of the LTA or vice-versa.
- SYNC Mode where LTA is cross-referenced with the LSA

MODELS:

Type-numbers	PM3551/10	PM3551/30	PM3551/50	PM3551/70
No of State Channels	35	35	59	59
No of 50MHz Timing Channels	-	8	-	8

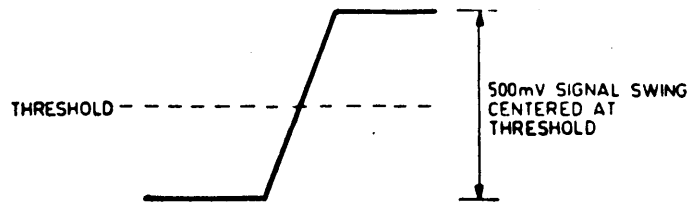

MA 10030

Fig.2.1 Minimal signal swing

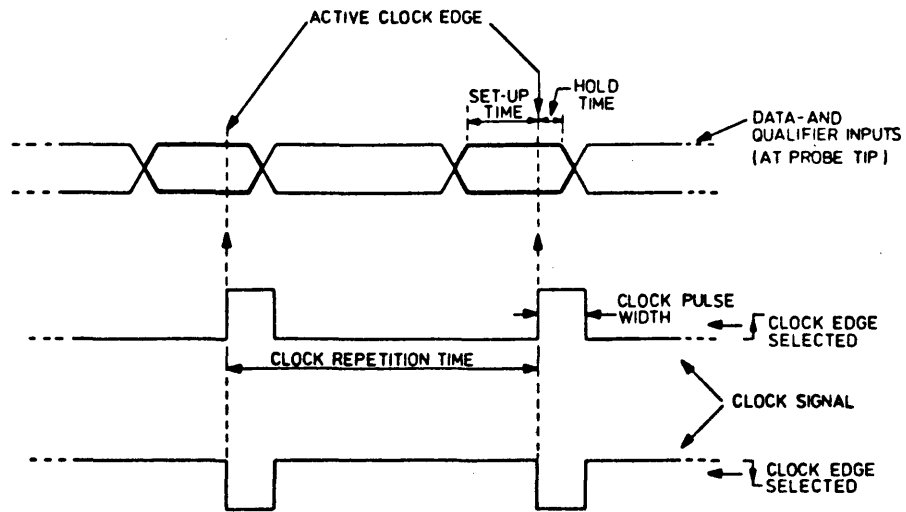

MA10531N

DESCRIPTION	VALUE
DATA AND QUALIFIER SET-UP	15 ns
DATA AND QUALIFIER HOLD	0 ns
CLOCK PULSE WIDTH	20 ns(min)
CLOCK REPETITION TIME	70 ns(min)

MA10531

Fig.2.2 Definition of terms and times

2.1 LOGIC STATE ANALYZER

Data Input : PM3551/10; 35 channels maximum via
5 Pods PM8821
PM3551/30; 35 channels maximum,
27 via 4 Pods PM8821 + 8 via 1 Pod PM8825
PM3551/50; 59 channels maximum via
8 Pods PM8821
PM3551/70; 59 channels maximum,
51 via 7 Pods PM8821 + 8 via 1 Pod PM8825

Pod Type : PM8821 and PM8825 multi-lead probe Pods
to be connected at the rear of the
instrument.

Following values are typical values and specified at the probe tip(s)

Impedance : 4 MOhm//6 pf

Max. input voltage : -50 V to +50 V

Threshold : Software selectable per pod.
Fixed TTL, ECL or variable selectable per
pod between -3 V and +12 V
in steps of 100 mV.

Max. sensitivity : 500 mV pp signal swing, centered on the
threshold voltage (see Fig. 2.1).

Set-up and hold times : Data set-up time minimum 25ns
Data hold time minimum 0ns
Both related to the active clock edge at
the probe tip (see Fig. 2.2).

Data acquisition : Data collected is selectable from:
a. states i.e. all combinations at inputs
are clocked in.

b. occurrences i.e. only certain types
of words are acquired.

c. combination of both.

Clock

Source : External (synchronous) clocking.

Number of clocks : Three separate clocks can be acquired via
3 leads of one multi-lead probe Pod PM8821.

Threshold : Same specification as data input (see also
Fig. 2.1).

Impedance and max. input voltage : Same specification as data input

Clock repetition time : Min. 70ns (see Fig. 2.2).
 Clockpulse width : Min. 20ns (see Fig. 2.2).
 Sampling : Selectable on positive or negative clock edge.

Clock qualifiers

Number : 2...4 clock qualifiers
 (input via one probe Pod PM8821)
 Two clock qualifiers are fixed, the other two are interchangeable with two data channels.

Threshold : Same specification as data input (see also Fig. 2.1).

Impedance and max. input voltage : Same specification as data input

Sampling : At clock edge and at selected qualifier level. True and False combinations are possible (see Fig. 2.2).

Selection : "1" for a high level
 "0" for a low level
 "X" for don't care (qualifier not in use).

Set-up and hold times : Data set-up time minimum 25ns
 Data hold time minimum 0ns
 Both related to the active clock edge at the probe tip (see Fig. 2.2).

Memory

Format : The memory depth is 1K (=1023) bits per channel.
 A second memory of the same size is available for compare mode operation.

Triggering

Source : 1) Internal, 2) Manual or 3) External
 (External socket TRIG IN is also input for trigger qualifier)

1) Internal : Triggering on up to 7 words, each delayed by a delay count, can be selected for:

- . Parallel and Quasi parallel triggering
- . Sequential triggering (ARM word(s) enable the TRIG word)
- . Immediate Sequential Triggering. Word N must be followed immediately by word N+1.

For all trigger modes, all combinations can be made with up to 7 words, clocks and delays.

Trigger words can be selected for "true" or "false" triggering.

The number of triggers can be preset and counted (see: Delay and Counter).

2) Manual : Operator controlled STOP.

3) External i.e. external trigger or trig. qualifier : Via input socket TRIG IN and PM8800 or PM 8810 probes. This input acts as an enable for the internal trigger logic and is selectable as edge or level active.

The external input offers the following possibilities:

- . When the internal trigger word is set as all don't cares, this input acts as an external trigger.
- . When the internal trigger word is defined this input acts as a trigger qualifier.
- . Connection for PM8810 Logic Trigger Probe

Following values are typical values and apply only when the specified probe is used.

Input Impedance : 5 MOhm // 15 pf

Max. Input Voltage : + 50 V

Threshold : Fixed TTL

Sensitivity : 500 mV_{pp} signal swing (see Fig. 2.1)

Set-up and hold times when PM8800 is used : Signal set-up time minimum 30ns
Signal hold time minimum 0ns
Both related to the active clock edge at the probe tip (see Fig. 2.2).

- Set-up and hold times when PM8810 is used : Signal set-up time minimum 50ns
Signal hold time minimum 5ns
Both related to the active clock edge at the probe tip.
- Delay : In the trigger menu, delay can be specified in the range of 0 to 64k steps
- as states of clock(s)
- in occurrences of word(s)
- in time
- Outputs : -MATCH OUT. Is activated by the MATCH OUTPUT ON WORDS:-statement in the trigger sequence list.
The output is TTL high when the trigger word occurs, and remains high until the next trigger word occurs.
The delay between input probe tip (PM 8821) and the Match out connector amounts to: 3 state clock cycles +50 +/-15 nS.
The pulse length is always more than 60 nS.
- RUN OUT. The output is TTL high during data acquisition.
The delay between internal start and stop, and the output is 25 +/-15 nS.
- Output specification:
-TTL compatible
-Source current 3 mA at Voh= 2,4 V.
-Sink current 3 mA at Vol= 0,5 V.
-Short-circuit proof.
-Max. ext. voltage + or -25 V.
- (outputs via BNC connectors at rear side)
- Input : TRIG IN
(input via BNC connector at rear side)

Selective data acquisition

- Selection : Up to two different blocks of selective data acquisition can be selected.
- Block limits : Start on a certain word or on START.
End on a certain word, word+trigger delay, or END.
- Selected data : Samples on specified clock(s).
-A specific word and samples on specified clock(s).

-One specific word.

-A specific word followed by a number (max. 255) samples on specified clocks.
This can be limited by a max. repeat of 512

Counter

: In Selective data menu, between specified start and finish, a counter can count:
-Samples with specific clock(s)
-Specific words
-Time

2.2 LOGIC TIMING ANALYZER

Data Input : 8 channels via 1 Pod
 Pod Type : PM8825 Pod to be connected
 at the rear of instrument.

Following values are typical values and specified at the probe tip(s).

Impedance : 1 MOhm // 5 pf
 Max. Input voltage : -50V to +50V
 Threshold : TTL, ECL or VAR
 variable selectable between -3 V and +12 V
 in steps of 100 mV.

Max. sensitivity : + 200 mV. with respect to threshold.
 level.

Maximum non-detect-
 able pulse width : 24 ns (=set up, + hold time + sample interval)

Channel to channel : <3 ns
 skew

Glitch detection : Selectable over all 8 channels.
 Glitches from 20ns sample period
 down to 5ns, selectable by user.

Clock

Source : Internal
 Fixed 20 ns (i.e. 50 MHz), transitional
 clocking system (refer to for
 explanation of transitional clocking).

Memory

Depth : 1/4 K bits per channel.
 (recording up to 256×10^6 samples)

Triggering

Source : 1) Internal, 2) Manual, 3) External and
4) Glitch

1) Internal : 3 modes: Word
Word + Glitch
Glitch after window
Triggering selectable on leading or
trailing edge of word match.
Timing and State can be combined in
COMBI mode and SYNC mode.

2) Manual : Operator controlled STOP.

3) External : Via input socket TRIG IN and PM8800
probe. This input is edge active.
Values apply only when the belonging
PM8800 probe is used.
This input can be used as input for a
trigger- or glitch qualifier signal, refer
also to next point 4.

Trigger filter : Selectable between 20ns--300ns,
in 20ns steps.

Input impedance : 5 MOhm // 15 pf

Max. input voltage : + 50 V

Threshold level : Same voltage at PM 8800 probe tip as at
input of PM 8825 Pod.

Sensitivity : 300 mVp-p with respect to threshold level.

Min. pulse width : 5 ns.

4) Glitchtriggering : Triggering on glitches on one selected
channel with a selected glitch width of
minimum 5 ns. up to a maximum of N sample
intervals where N is selectable between
1 and 15. One sample interval is 20 ns.

Glitch window : Defining a window by an arming word (start)
plus a delay (finish) within which the
analyzer is looking for glitches.

Glitch-qualifier : Via input socket TRIG IN and PM8800 probe
or with the same characteristics as
Trigger-qualifier "External" point 3).
Used as glitch-qualifier an extra trigger
condition is added to the glitch-triggering
e.g. to control a glitch window.
Used as trigger-qualifier it enables the
selected timing triggerword to be
extended with one bit.

<u>Delay</u>	: 1) Time delay and 2) final delay
1) Time delay	: Max. 20×2^{20} nsec. =20971 usec. via a 20 bit counter which counts in steps of 20 nsec.
2) Final delay	: Max. 255 transitions
<u>Output</u>	: MATCH OUT: ECL level, True (high), when the selected trigger word is true until the next trigger word appears. (output via BNC connector at rear side)
<u>Input</u>	: TRIG IN: (input via BNC connector at rear side).

2.3 OPERATION

Operation is by key actions combined with various data or menu displays. The keys are divided into two key fields, see also front panel layout, Fig.3.2 :

Front panel keys	: Allow user direct access to the analyzer display modes and control functions.
Key-board keys	: Allow the user to enter the required parameters within a display mode. This keyboard is based on a combination of hard-keys (for cursor control and HEX value entry) and soft-keys (when entry is not a HEX character).

2.4 DISPLAY

The display is a green phosphor 9 inch video display. This video display can show a maximum of 24 text lines when the instrument is in a full menu mode. When in data display mode the display is divided into three fields (see also front panel layout, Fig.3.2) :

Heading	: The top 6 lines of the display which contain a condensed menu display.
Data field	: The centre 16 lines of the display. This area contains the data display.
Softkey function field	: The bottom 2 lines of the display which display the functions of the softkeys located under the display.

- EXTERNAL DISPLAY : Via BNC output connector COMP VIDEO at the rear side of the instrument.
- Display scan : Non-interlaced
 - Number of display lines : Total 312, visible 256
 - Cable matching impedance : 75 Ohm
 - Polarity : High level is bright
 - Sync pulses : 20%...40% of total
 - Line frequency : 15600 Hz
 - Frame frequency : 50 Hz
 - Max video bandwidth : 10,7 MHz
 - External display timing : See figure 2.3.

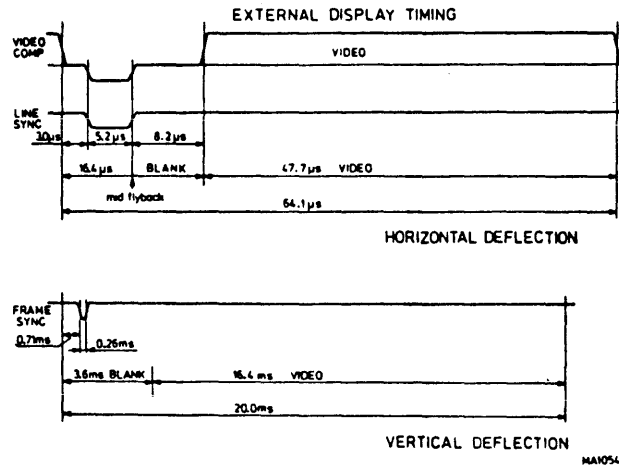

Fig.2.3 External display timing

2.5 DISPLAY MODES

- Data display** : State list display; binary, octal, decimal, hexadecimal, ASCII or combinations of these. Inverted display by groups or by individual channels is possible.
- : Timing display; 8 channel format, vertical expansion by channel delete, horizontal scale continuously controllable.
 - : Graphic display; data magnitude is plotted against time sequence.
- Menu display** : For specification of parameter set-ups the following menus can be displayed:
- Configuration menu
 - Trigger menu (State or Timing)
 - Data acquisition menu
 - Compare menu
 - Option menu

2.6 COMPARE MODE

Memory	:	A reference memory is available to store the contents of the acquisition memories of both state and timing. This memory can also be loaded via the optional interface.
Store	:	With the store function, data contained in the acquisition memory is copied into the reference memory.
Modes	:	Full compare: The two entire memories are compared
		Compare Mask: Channels over which the compare takes place and the limits of the compare with respect to the trigger point are defined by the user.
		Offset: Shift of stored data (masked) with respect to current data.
		Skew: Timing only This allows deviation of an edge in the current data with respect to stored data.
		Search: Stops continuous compare process when an inequality is found, or counts equalities or inequalities.

2.7 POWER SUPPLY

AC Supply	:	Safety Class I	IEC-348, ECMA-57
Power consumption	:	130 VA	PM 3551/10
	:	250 VA	PM 3551/30
	:	180 VA	PM 3551/50
	:	280 VA	PM 3551/70
Nominal mains-voltage ranges	:	110...127 Vac \pm 10% or 220...240 Vac \pm 10%	Mains fuses 4A delayed (2x), both mains-voltage ranges
Nominal frequency range	:	50...60 Hz \pm 10%	

2.8 ENVIRONMENTAL CHARACTERISTICS

The characteristics are valid only if the instrument is checked in accordance with the official checking procedure. Details of these procedures and failure criteria are supplied on request by the PHILIPS organization in your country, or by N.V. PHILIPS' GLOEILAMPENFABRIEKEN, TEST AND MEASURING DEPARTMENT, EINDHOVEN, THE NETHERLANDS.

-CLIMATIC CONDITIONS

Ambient temperature

Rated range of use + 5 ...+ 40 Deg.C

Limit range of operation 0 ...+ 45 Deg.C

Limit range for storage and transport -40 ...+ 70 Deg.C

Relative humidity

Rated range of use 20% ... 80% Non condensing

Limit range for storage and transport 5% ... 95%

Altitude

Rated range of use up to 5000 m.

Limit range for storage and transport up to 15000 m.

Mains Interruption

10 ms (nominal mains supply) No influence on settings and data storage.

-MECHANICAL CONDITIONSVibration

Rated range of use	Negligible value	
Limit range for storage and transport	0.28 mm(p-p) max. 20 m/s ²	Frequency range 10 ... 150 Hz

Bump

Rated range of use	10 m/s ²	6 ms
Limit range for storage and transport	100 m/s ²	1000X, 6 ms in each of 3 directions

Electromagnetic Compatibility (EMC)Electromagnetic Interference (EMI)

Conducted interference	level B 10 kHz ... 30 MHz	VDE 0871
Radiated interference	level B	VDE 0871

Electromagnetic susceptibility (EMS)

Conducted susceptibility

Transients on mains connections (ingoing)		Assymetrical only
---	--	-------------------

Fast low energy pulses

Pulse height	1500 V max.	No damage to occur
Rise time	35 ns. max.	
Pulse width	100 ns. approx.	
Source impedance	150 Ohm max.	

2.9 PHYSICAL CHARACTERISTICS

Dimensions

Width	450 mm
Height incl. feet	242 mm
Height excl. feet	227 mm
Depth max.	570 mm
Depth min.	496 mm

Weight

Net, without accessories and options
17 kg(approx.)

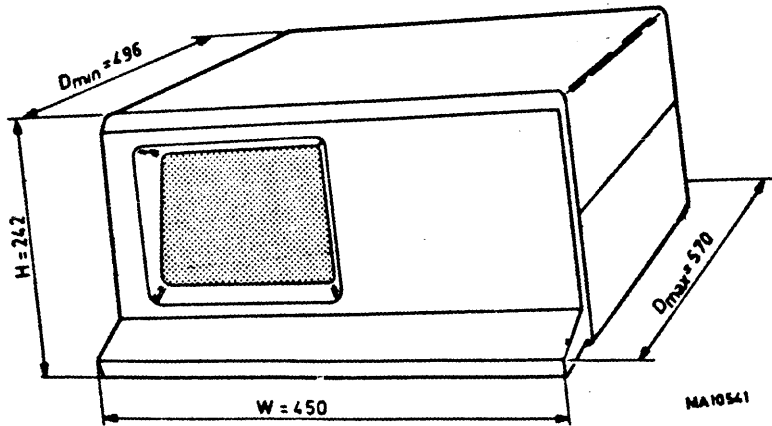

Fig.2.4 Dimensional drawing

2.10 ACCESSORIES AND OPTIONS**-Accessories included in delivery:**

1	Operating manual	
5	8-channel pods (with PM 3551/10)	PM 8821
4	8-channel pods (with PM 3551/30)	PM 8821
8	8-channel pods (with PM 3551/50)	PM 8821
7	8-channel pods (with PM 3551/70)	PM 8821
1	8-channel timing pod (with PM 3551/30 & /70)	PM 8825

-Instrument "upgrading" options (These options are field-installable):

PM 8850/00	DISA A (Z80, 8085, 68000 Disassembler)	
PM 8850/10	DISA N (Intel Disassembler)	
PM 8850/20	DISA M (Motorola Disassembler)	
PM 8850/30	DISA Z (Zilog Disassembler)	
PM 8850/40	DISA R (Rockwell/RCA/NS Disassembler)	
PM 8850/80	Non-volatile memory for storage of 4 user-defined instrument settings.	

The above PM 8850/xx options can be installed on the Options board PM 8851/00/20 or /40.

PM 8851/00	Options board with printer output.
PM 8851/20	Options board with printer output + RS 232C control interface.
PM 8851/30	8 channel 50 MHz timing analyzer (T50-1,2)
PM 8851/40	Options board with printer output + IEEE 488 (IEC 625) control interface.
PM 8851/50	Additional 24 channel state analyzer (S15-3).
PM 8851/70	Additional 4 channel timing analyzer 300 MHz.

The printer output is always RS232C.

-Optional accessories:

PM 8800	External trigger probe (set of four probes)
PM 8810	Logic trigger probe
PM 8811	Serial data pod
PM 8817/19	Personality adaptor for 68000
PM 8817/40	Personality adaptor for 40-pin micro processors
PM 8817/64	Personality adaptor for 64-pin micro processors

-Parts of accessories:

PM 8815/00	5 Pod nozzles for personality adaptor
PM 8815/40	40-pin clip with ribbon cable.
PM 8815/64	64-pin clip with ribbon cable.
PM 8816/19	Personality box for 68000.
PM 8816/40	Personality box for 40-pin micro processors
PM 8816/64	Personality box for 64-pin micro processors
PM 8819/00	Extension kit for PM 8821 (leads, clips and nozzle)
PM 8819/10	54 coloured leads for PM 8821 (length 26 cm)
PM 8819/20	35 measuring clips
PM 8819/30	50 mini dualclips
PM 8819/40	54 coloured leads for PM 8825 (length 12 cm)

Note: For more information refer to the chapter 9.

GENERAL DIRECTIONS

3.0 GENERAL DIRECTIONS

3.1 WARNINGS AND INFORMATION FOR THE USER

- It is recommended that this section is read completely before switching on the instrument.
- This instrument has been designed and tested in accordance with IEC Publication 348, Class 1, Safety Requirements for Electronic Measuring Instruments and has been supplied in safe condition. This Manual contains information and warnings, all of which must be considered to ensure safe and reliable operation of the instrument.

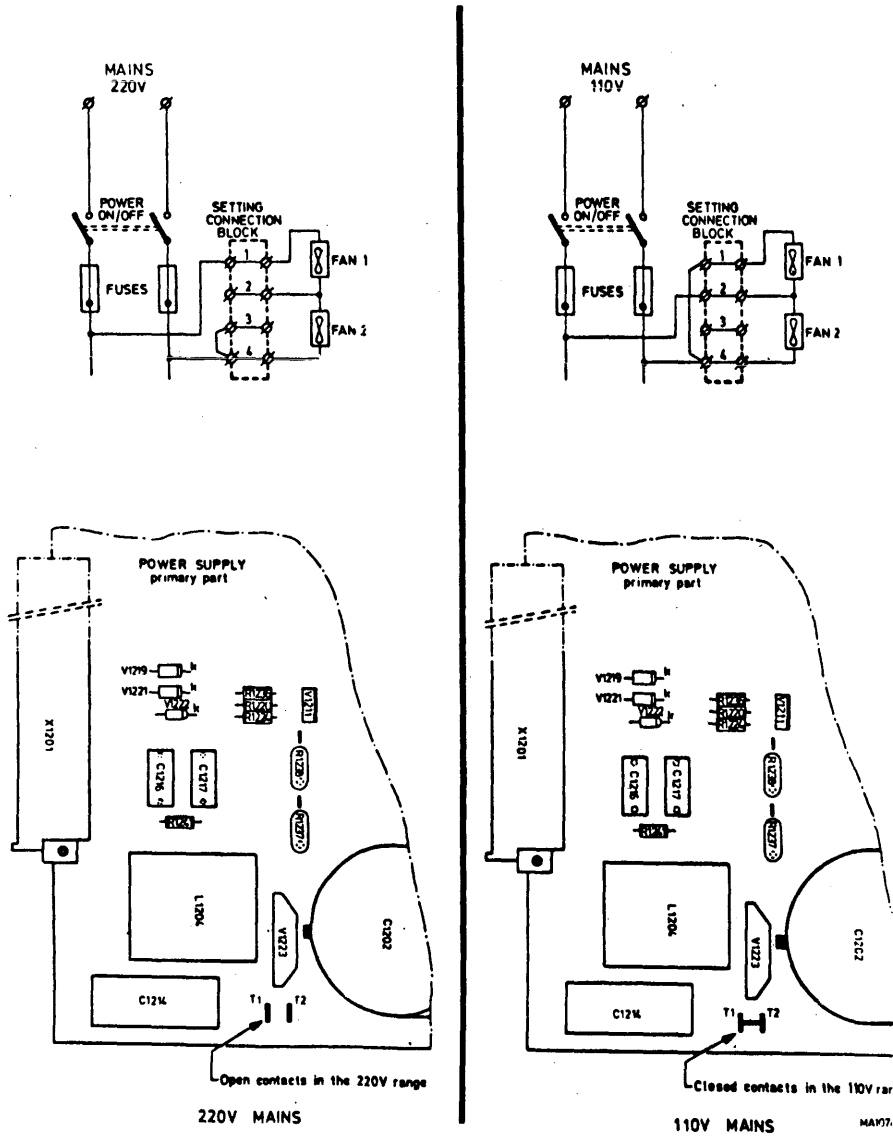

Fig. 3.1 Connecting for 220 V or 110 V range mains voltage.

Mains adaption

- Before connecting the instrument to the mains supply, ensure that it is set to the correct voltage range. To do this, the upper cabinet plate has to be removed and it can be seen if some connections of the power supply compartment are set to the relevant voltage range. Range settings are shown in figure 3.1. New instruments are shipped with the voltage range setting correct for the country of destination.

Earthing

- Before switching on, the instrument shall be connected to a protective earth conductor in one of the following ways:
 - . via the protective earth terminal at the rear of the instrument, identified by the symbol (⏏).
 - . via the earth wire in the three-core mains cable.

The mains plug shall only be inserted in a socket outlet provided with a protective earth contact. The protective action shall not be negated by the use of an extension cord without protective conductor. Replacing the mains plug is at the user's own risk.

WARNING: Any interruption of the protective conductor inside or outside the instrument, or disconnection of the protective earth terminal, is likely to render the instrument dangerous. Intentional interruption is discouraged. When an instrument is brought from a cold to a warm environment, condensation may cause a hazardous condition. Ensure, therefore, that the earthing requirements are strictly adhered to.

Cooling

- Take care that the forced air flow through the instrument is not obstructed. Do not place any instruments or papers on the top of the instrument to avoid excessive heating-up.
- Do not use the instrument when the built-in fans are not running.

Adjustment, replacement of parts and repair

- When the instrument is connected to the mains, terminals may be live, and the opening of the covers or the removal of parts (except those to which access can be gained by hand) is likely to expose live parts.
- The instrument shall be disconnected from all voltage sources before it is opened for any adjustment, repair, replacement or maintenance.
- Capacitors inside the instrument may still be charged even if the instrument has been disconnected from all voltage sources.
- Any adjustment, repair or maintenance of the instrument, when opened under voltage, should be avoided as far as possible, and, if inevitable, should only be carried out by a skilled person who is aware of the hazards involved.
- Never remove a circuit-board or component until the instrument has been switched-off for at least one minute.
- Ensure that only fuses with the required rated current and of the specified type are used for replacement.
The use of make-shift fuses and the short-circuiting of fuse holders is prohibited.

Maintenance

- Cooling
Check the vent holes and the dust filter (located in the bottom plate) once a year.
If necessary free the holes (use pressurized air).
When the filter is clogged with dust, it must be replaced.
Ordering number dust filter: 5322 480 40142.
- Cleaning
If necessary, the VDU glass surface, the front panel, and the cabinet-plates may be cleaned with a soft pad, cloth, or cotton-wool with some water and common household cleansing, or some alcohol or white spirit.
Do not use abrasive cleaning pads or materials.

Nickel-cadmium battery

The non-volatile instrument setting memory is energized by a 3.6V nickel-cadmium battery located on the video interface unit (VIU-1). This battery requires no special maintenance.
Bad battery condition is generally indicated by the message SETTING INVALID when selecting a saved or stored setting.
A battery in bad condition must be replaced (call your local Philips Service Organization).

Note that this battery may never be opened, nor short-circuited, nor be thrown in open fire.

Defects and abnormal stresses

- Whenever it is likely that the protection has been impaired, the instrument should be made inoperative and secured against any further operation.
- The protection is likely to have been impaired if, for example, the instrument:
 - . shows visible damage.
 - . fails to perform its intended functions.
 - . has been subjected to prolonged storage under unfavourable conditions.
 - . has been subjected to severe stresses during transport.

Power up self test

- When switching-on, the microprocessor initiates a test program wherein it checks the immediate microprocessor environment, keyboard and memories.
If this test gives a faulty result, the C.R.T. remains blank.
If a RAM is faulty, the wrong address is displayed binary.

Service test

- The instrument is provided with a service test program as an aid to pin-point any functional defect. This program is selected by pressing - and - pushbuttons simultaneously.
The service test program consists of a number of separate test modules, sequentially activated. The first module is entered when selecting the test program. A test module is dealing with a particular way of testing or with the testing of a particular part of the circuit. By depressing the - pushbutton the next testmodule is entered. Pressing the - and - pushbuttons simultaneously leads to a return back to the operational program. More information about the "service test" will be given in the (separate) SERVICE MANUAL of this instrument.

Turning power on

For connecting and detailed preparation for use refer to chapter 6.

- The instrument is turned on by switching the power ON/OFF switch at the rear of the instrument to ON. See also figure 3.3
- Check that the built-in fans are running.
- The initial configuration menu appears on the display.

3.2 DESCRIPTION OF CONTROLS, CONNECTORS AND DISPLAY

This section describes the operation and function of controls and sockets on the instrument. The front panel's functional areas as well as the controls in those areas are explained in the sequence they would normally be used by the operator.

3.2.1 FRONT PANEL

Fig. 3.2 Front panel

CURSOR position area

- CURSOR IN HEADING** : This button forces the cursor into the heading (this is the condensed menu).
- CURSOR IN DATA FIELD** : This button forces the cursor into the data field.

The cursor can be located on one character only, or on a group of characters. The cursor generally consists of a reverse video block combined with a blinking character.

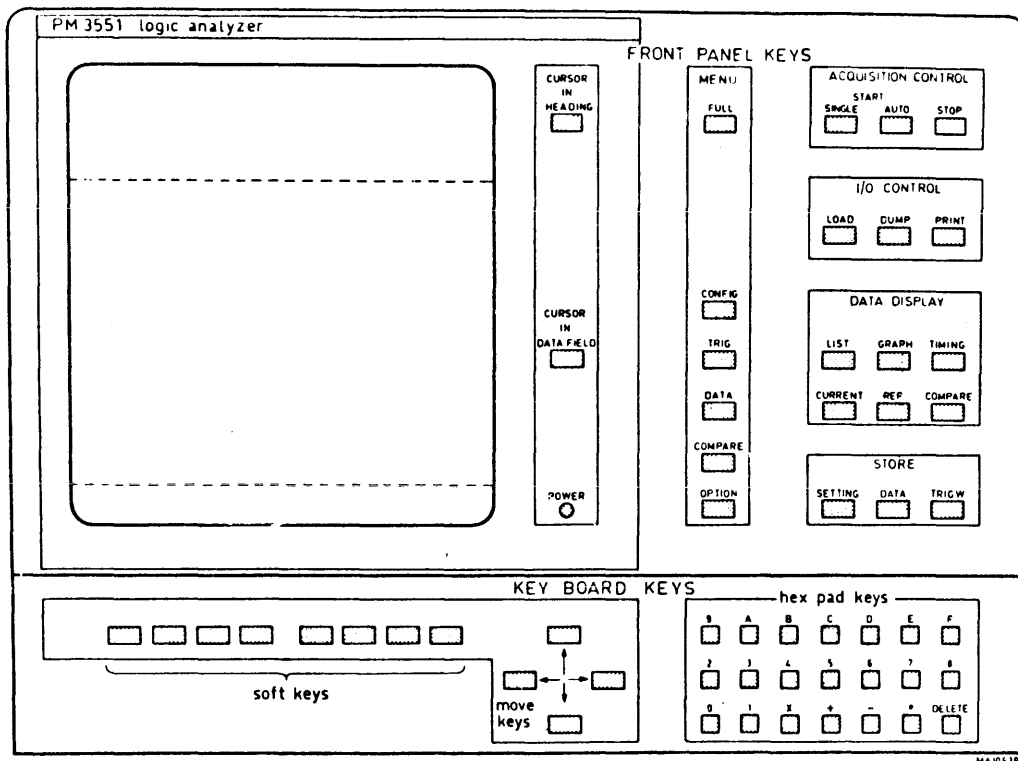
The cursor can be moved with the four move keys.

- POWER (lamp)** : Indicates that the instrument is switched-on.
(The main switch and fuses are located at the rear panel).

MENU area

FULL : Selects a Full menu (refer to Menu Description).
 CONFIG : Selects the Configuration menu
 TRIG : Selects the Trigger menu
 (When both the State- and the Timing analyzers have been selected, this key gives alternatively the state- and the timing trigger menus)
 DATA : Selects the Data menu
 COMPARE : Selects the Compare menu
 OPTION : Selects the Options menu

ACQUISITION CONTROL area

START SINGLE : Starts a single shot data acquisition action.
 START AUTO : Starts an automatic restart data acquisition action.
 STOP : Stops data acquisition in single, as well as in auto mode.

I/O CONTROL area (only active if an interface option has been installed)

LOAD : The analyzer memory is loaded with data from a storage device, or controller.
 DUMP : The analyzer memory contents is transferred to a storage device or controller.
 PRINT : The analyzer memory contents is transferred to a printer.

DATA DISPLAY area

LIST : Memory contents is displayed in a list format.
 GRAPH : Memory contents is displayed in a graph format.
 LIST and GRAPH display apply only to the State Analyzer.
 TIMING : Memory contents is displayed as blockform signals
 This applies only to the Timing Analyzer.
 CURRENT : The contents of the current memory is displayed.
 REF : The contents of the reference memory is displayed.
 COMPARE : The contents of the current memory and the contents of the reference memory are compared.

STORE area

SETTING : The settings of the analyzer are stored
 (only if an option PM 8850/80 has been installed).
 DATA : The contents of the current memory is copied into the reference memory.
 TRIGW : The cursor word (which is the uppermost word of the displayed data list) is copied into the censored trigger word in the trigger menu.

SOFTKEYS

There are 8 softkeys, located directly underneath the display. Each active softkey function is displayed in inverse video, just above the key. A disabled softkey function is presented in normal video.

MOVE KEYS (scroll,shift)

These keys have two functions:

- Positioning of the cursor in the menus, or in the label line in the data field.
- Scrolling the data list, or horizontal shift of the timing display window.

HEX KEYS

The hex keys (0---F) permit hexadecimal input for the various settings.

- X = don't care
- . = decimal sign
- DELETE = deletes full numerical input

3.2.2 REAR PANEL

Fig. 3.3 Rear panel

Seen from the rear, you find from left to right the following unit indication:

-S15.1 S15.2 S15.3 (the latter only in versions /50 and /70)
S indicates State Analyzer p.c. boards.

-T50.1 T50.2 (both only in versions /30 and /70)
T indicates Timing Analyzer p.c. boards.

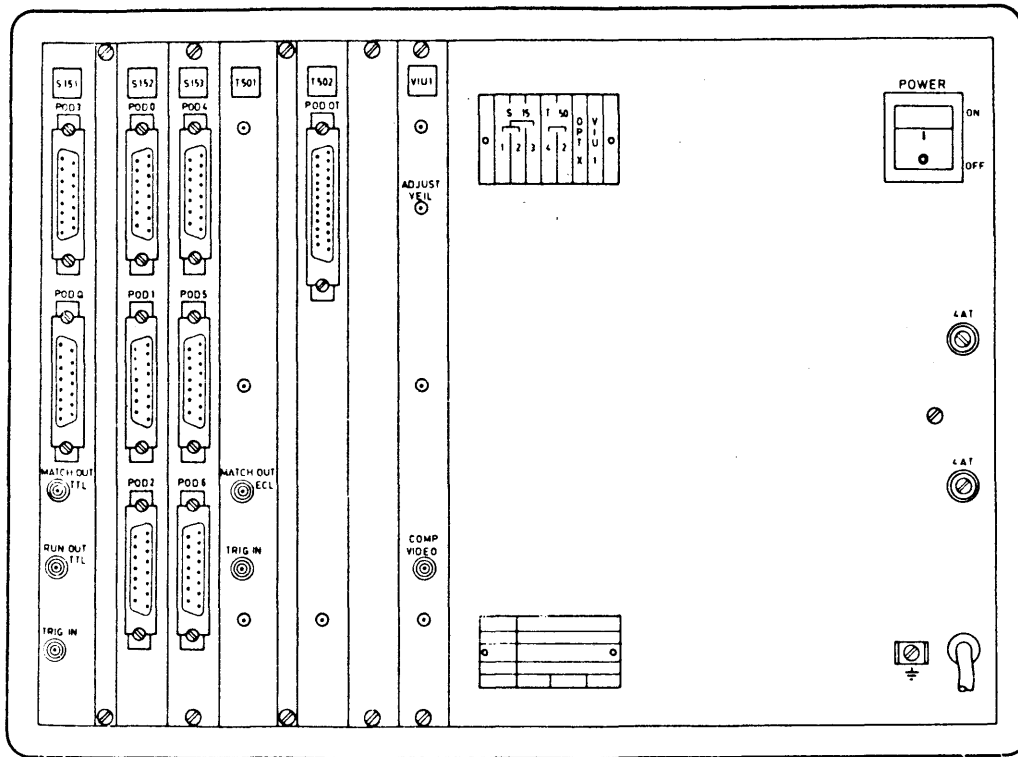
-OPT.X (instructions for field fitting are given in the service manual, and are delivered with the option).
 p.c. Board for instrument options.

-VIU.1 (video interface unit)
 Video interface p.c. board.

On above mentioned units you will find the following:

1 State section

On S15.1 and S15.2 the input connectors are located for POD#0, POD#1, POD#2, POD#3 and POD#Q.

The POD#0 input is not present in the /30 and /70 models, where POD#0 data is taken internally from the Timing POD PM 8825. So Pod#0 data can then be displayed in a list as well as in a timing diagram.

POD#0...POD#3 are data inputs; POD#Q is input for clocks and qualifiers (two of the qualifiers may be used as data channels).

On S15.3 the input connectors are located for POD#4, POD#5 and POD#6. All these inputs are 15 pins input connectors to connect PM 8821 PODs.

On S15.1 three BNC connectors are present:

- MATCH OUT delivers an active high TTL signal if a trigger word occurs.
- RUN OUT is delivering an active high TTL signal during data acquisition, i.e. between start and stop (final triggering).
- TRIG IN features triggering of the data acquisition with an external signal. The external signal must be fed via the PM 8800 probe and is specified as TTL level at the probe tip.

2 Timing section

On T50.1 and T50.2 the following connectors are present:

- POD#OT 25 pins input connector for 8 timing channels (data input via POD PM 8825).
- MATCH OUT BNC connector, delivering a high active ECL signal during the time that the selected trigger word is true and clock pulse(s) is (are) present.
- TRIG IN BNC connector features triggering of the data acquisition with an external signal. The external signal must be fed via the PM 8800 probe and can be selected between -3V and +12V at the probe tip. (Threshold is adjustable at the relevant p.c. board). An unused input is regarded as a "0".

3 Video Interface Unit (VIU):

- ADJUST VEIL allows brightness adjustment of the veil in the timing display.
- COMP VIDEO BNC output giving a video signal (1.25 Vp-p) to connect an external video display. This signal includes line- and frame sync pulses.

Mains section

- Mains switch
- Two fuses 4 Amps (delayed action) for both the 110V and 220V ranges.
- Mains cord provided with gnd wire
- Separate gnd connection

Brightness adjustment

- At the LEFT HAND SIDE of the instrument;
- Screw driver adjustment for brightness of the display.

D E S C R I P T I O N O F T H E M E N U S

DESCRIPTION OF THE MENUSWHAT'S A MENU?

A menu is a survey of specific functions, parameters and values which apply to a certain main analyzer mode or function.

There are full menus and condensed menus.

A full menu states full detailed information and requires the whole display area.

A condensed menu states just the most relevant information leaving room for a display field for data.

The following menus are selectable:

- Configuration menu
- Trigger menu state section
- Trigger menu timing section
- Selective data acquisition menu
- Compare menu
- Options menu

For each full menu a condensed menu is available (options menu excepted). Changes in a full menu are automatically copied in the corresponding condensed menu; changes in condensed menus are not all copied in the corresponding full menu.

Selectable functions are indicated by the cursor and the labels above the softkeys.

The cursor, which puts the selected function or value in inversed video, can be positioned with the four arrow keys.

Note that with each new cursor position, the softkey functions may change.

By pressing the relevant softkey the function or parameter is selected.

When you switch-off the instrument, all settings in the menus remain stored in a battery back-up memory. The configuration menu photographs in this chapter show the default values of the settings after switching on.

First we discuss the full menus.

4.1 FULL MENUS

4.1.1 CONFIGURATION MENU

General information

In this chapter we discuss the menus of an Instrument provided with 35 or 59 state channels and 8 timing channels, so skip numbers or functions which are not applicable in your Instrument.

Press the FULL- and the CONFIG key in the MENU area.

(after switching-on the instrument display shows always the initial full Configuration Menu)

Note that the current instrument setting is always saved in a battery back-up memory, when the mains voltage is switched off.

In the following we discuss the menus as in the initial setting.

```

                                CONFIGURATION MENU

MODE          59 CHANNEL STATE WITH 8 TIMING

CLOCKS        CLOCKS          QUALIFIERS Q0 Q1 Q2 Q3
              CLK0= f         TRUE      X X X X
              CLK1= 1         TRUE      X X X X
              CLK2= 0

DATA INPUT    THRESHOLD AND CLOCKS VS. LABELS

  POD#0 POD#6   POD#5  POD#4   POD#3  POD#2   POD#1  POD#0
  TTL  TTL     TTL   TTL     TTL   TTL     TTL   TTL
0 AAAAAAAAAA BBBBEEEEEEEE CCCCCCCCCCCC DDDDDDDDDDDDDDD
1 ----- EEEEEEEEEEEEEEE EEEEEEEEEEEEEEE GGGGGGGGGGGGGGG
CLK INT=                                     TTTTTTTT

FORMAT AAA BBBB CCCC DDDD EEEE FFFF GGGG
LOGIC  POS POS  POS POS  POS POS  POS
BASE   HEX HEX  HEX HEX  HEX HEX  HEX

  CLOCKS          QUALIFIERS
  OFF  f  1  TRUE  FALSE  1  0  X
  
```

Fig. 4.1 Full Configuration Menu

MODE

The following modes are selectable:

- COMBI This mode applies typically for combinative use of both the State Analyzer and the Timing Analyzer. Each Analyzer is capable of enabling the triggering of the other Analyzer (LSA enables LTA, or LSA waits for LTA). Start data acquisition is common for both Analyzers.
- STATE In this mode your instrument is a State Analyzer only.
- TIME Now you have a Timing Analyzer only (max 8 channels).
- SYNCED The Timing Analyzer will now run synchronously with the State Analyzer. The Timing Analyzer being triggered by the ENABLE LTA command. Both Analyzers work on their own sample clock, but reference is obtained between both captured data. You will miss two timing channels; they are used for synchronization purposes between both analyzers. Samples captured with the State Analyzer are marked in the timing diagram.
- STORED If the setting memory PM8850/80 is built-in this key is enabled. You can recall one out of four stored instrument settings. Refer to page 4.6.
- SAVED Pressing this key recalls the complete instrument setting as it was when the instrument was switched off. If the instrument setting was not correct at the moment of switching-off, the message INVALID SETTING will be shown when the saved key is pressed.

CLOCKS

Allows you to select the active clocks and clock-edges. Also the corresponding qualifiers and their polarity can be selected. Note that at least one clock must be selected.

DATA INPUT THRESHOLD AND CLOCKS VS. LABELS

In this field you can select labels per active clock, and the logic threshold voltage per Pod. In the 35-channel state analyzer version this field consists of the following two fields.

THRESHOLD

A correct threshold voltage is important to obtain a reliable logic level detection of the input signals. The threshold voltage is selectable per Pod. You can select TTL, ECL, or VAR. VAR is any value between -3V and +12V, and must be entered via the HEX key pad.

LABELING

This function allows you to label groups of input channels; the same labels remain present in all further displays.

Available labels are A---G.

Channels of adjacent Pods can be grouped together by giving them the same label.

Labels may be allocated in any order in this field, but the resulted display format (see the FORMAT line) is always in alphabetical order. Certain rules apply to the allocation of labels:

- Labels must be allocated on a contiguous block basis.
- The same label can be allocated to two or more clock sources, provided it covers the same channel inputs.

Note that the labeling is also related to the base-selection which is discussed in the next points.

Timing channels have basically label T (for timing) with a channel number. If the capture mode has been selected the label C applies.

LOGIC

This function and the BASE (see point 6) one have a combined cursor. Logic applies to the logic (polarity) of the input signals.

Often positive logic is used, where '1' is a high voltage, and '0' is a low voltage.

An exception is e.g. IEEE/IEC bus logic, where a '1' is a low voltage and a '0' is a high voltage.

In this case pressing the NEG soft key will result in the active low systems signals being displayed as 1's.

BASE

The base is the numerical base, or the code in which the data will be represented.

The base can be binary, hexadecimal, octal, decimal or ASCII7.

The base selection is related to the above channel-labeling.

Generally a specific number of bits is used per base setting.

E.g. if octal base has been selected, the labeling must be logically in a group of three channels (though other numbers are allowed).

The value of non-activated bits in a group depends on the selected logic, selected threshold, etc.

The STORED softkey allows selection of one out of four settings of the non-volatile memory. The settings are each stored under label #1 -- #4.

The SAVED softkey recalls the setting as it was at the moment you switched-off the instrument before (this is retained in a battery back-up memory).

After switching-on, the instrument menus are always in the initial default setting.

-How to STORE a SETTING.

Press the Store Setting key in the STORE field.

The message STORE ON Y blinks on the display, in which Y is the label number under which this setting is stored.

The label numbering starts initially on #1, the next one on #2, and so on.

Note that it takes approx. 10 Sec. (typ.) up to 1 Min. 20 Sec. (max.) to store one complete setting.

Do not switch off the instrument during this store cycle, otherwise this setting will be lost.

As soon as the message STORE ON Y disappears, the setting has been completely stored.

If attempts are made to store an instrument setting and all four labels are occupied, the message NO FREE LABELS flashes on the display.

The display changes to the configuration menu with the message: ERASE AND STORE ON LABEL X (with the flashing cursor on X).

The softkey functions are now:

```
--#1--  --#2--  --#3--  --#4--  -ENTER  -NONE-  -----  -----
```

Find out which of the settings on label 1--4 can be erased and replaced by the new setting. Enter that number by pressing the relevant softkey and press the ENTER softkey. If erroneously a wrong label number softkey has been pressed, you can correct this by pressing the NONE softkey.

-How to RECALL a SETTING

Select the full configuration menu.

Press the STORED softkey.

The message RECALL STORED LABEL Y (with the flashing cursor on Y), appears on the display and the softkey functions are the same as indicated above.

Press the relevant label number softkey and press the ENTER softkey. If erroneously a wrong label number softkey has been pressed, correct this by pressing the NONE softkey.

Experience has proven that it is quit useful to note the setting details of each stored setting for yourself.

4.1.2 TRIGGER MENU

Press the FULL- and the TRIG key in the MENU area.

Note that in versions PM 3551/30/70 there are two trigger menus. One for the state analyzer and one for timing analyzer. In the COMBI-mode, these menus are alternately displayed by pressing the TRIG key.

State trigger menu

```

STATE TRIGGER MENU
TRIGGER ON SEQUENCE TRUE
1 FIND WORD 1 DELAY = 100 STATES OF CLK 0
2 FIND WORD 2
3 FIND WORD 3 OR 4
  IF WORD 3 THEN STEP 1 ELSE STEP 4
4 FIND WORD 5 DELAY = 1000 STATES OF CLK 0+1
5 END. MATCH OUT ON WORDS: 5

```

```

WD CLK AAA BBBB CCCC DDDD EEEE FFFF GGGG Q F
1 0 XXX XXXX XXXX XXXX X T
2 0 7E6 021C 4C00 22FF X T
3 1 00438 4C66 00FF X T
4 1 00438 3A67 F4FF X T
5 0 7E6 021C 4412 10FF X T

```

```

0 1 2 _____

```

Fig. 4.2 State Trigger Menu

This menu is divided in 3 main fields, from top to bottom:

```

**STATE TRIGGER MENU**
- TRIGGER ON SEQUENCE TRUE, OR -BREAK

- SEQUENCE
- -
- -

TRIGGER-WORDS
- -
- -

```

TRIGGER ON SEQUENCE TRUE, OR -BREAK

1. Trigger on sequence true

In this mode a number of conditions must be fulfilled in a specific order to obtain triggering.

2. Trigger on sequence break

A number of conditions must be sequentially fulfilled; if the sequence is broken triggering occurs.

SEQUENCE

In this field you can write the trigger sequence order. This list is divided in steps, numbered from 1 onwards. The various trigger words are labelled as 1--6 (or 7). You can enter trigger words, delays, if-then-else conditions and so on.

Note that these trigger words can also be used in the selective data acquisition- and the compare menu.

For detailed information on the trigger sequence possibilities refer to chapter:

Note that in the Combi mode linkage can be made between the State-analyzer- and the Timing analyzer triggering.

Two functions are possible:

-Enable LTA : The State analyzer enables triggering of the Timing analyzer.

-Wait for LTA : The State analyzer starts the Timing analyzer. After triggering (incl. the delays) of the Timing analyzer, the next trigger word of the State analyzer is enabled.

TRIGGER WORDS

Trigger words are initiated in the trigger sequence list.

As soon as a word has been selected in the sequence list, it appears in the 'don't care'-form in the trigger word list.

Note that the trigger words can only be set in binary-, octal- or hexadecimal form.

Words 1--6 are the principal trigger words. Each of these words can also be used by a delay counter (delay on occurrences) in the trigger step were it is used as the trigger word.

At the same time, each of the words 1--6 may be used with:

-the selective data acquisition, to define start and stop of sample windows.

-the counter, to define start and stop of the counter window.

-the compare function, to define the start and stop of the memory block to be compared.

Two more words, word A and word B, are available:

They can be used as:

-an occurrences delay counter in every trigger step

-a word to be captured by selective data acquisition

-a word to be counted by the counter

In addition word B can also be used as a trigger word in the trigger sequence; in this case word B is labelled as word 7.

In the heading of the trigger word list you find:

```
WD CLK <LABELS> Q F
```

In which:

WD is trigger word number.

CLK is the clock source for that trigger word.

<Labels> is the indication of the selected channel labels.

Q is the polarity of the external trigger word qualifier, or the external trigger edge signal. See below.

F is the definition (true or false) of the trigger word with qualifier.

In the trigger word list you find the trigger words as soon as they are initiated in the trigger sequence list.

Note that clock numbers, qualifiers, and the True or False condition are entered via the softkeys.

The trigger word itself is entered via the hex keyboard.

Some trigger qualifier details.

Q is the external trigger word qualifier, or the external trigger edge signal, and must be applied to the TRIG IN connector at the rear of the State Analyzer (S15.1).

Note that this signal controls all trigger word qualifiers as far as they have been specified. With the control cursor positioned on the qualifier of the trigger word, the soft key labels are:

```

DELAYED EDGE      DELAYED LEVEL NOT DELAYED
--|--      --|--      --|--      --O--      --H--      --L--      --X--      -----

```

Note that the Delayed Edge- and Delayed Level functions apply to the Logic Probe PM 8800. These functions compensate the delay of the data Pods (PM 8821).

The Not Delayed functions apply to the PM 8810 Trigger Probe, or it may be a TTL signal applied via a coax. cable.

Delayed- and Not Delayed qualifier functions do not work together.

Note that edge triggering works as a latch function. Once the selected qualifier input edge signal has passed, it remains latched for the rest of the trigger sequence. Accordingly, the edge trigger can only be selected once in the trigger sequence. Combinations of one edge qualifier and two or more level qualifiers are possible.

Trigger Sequence Softkeys Functions

In the following we give an example with some principal trigger functions. In this example we succesively pressed the left-most softkey.

For more information on trigger functions refer to chapter. 5.2.

TRUE BREAK -----

selects the main trigger mode.

Sequence TRUE means triggering after fulfilment of all trigger conditions.

Sequence BREAK means triggering is obtained if a trigger word is found which is not in the right sequence.

In the sequence break trigger mode, one trigger word per step can be set. Each trigger word may be with or without delay, the last step refers (with a GOTO statement) to a step earlier in the list to obtain the sequence.

Note that in the following example, if WRD1 or WRD2 is found in the sequence WRD3->WRD4->WRD5->WRD3 also triggering occurs (also if WRD1 or WRD2 are sampled with another clock). Refer to Fig. 4.3.

- 1 FIND WORD 1
- 2 FIND WORD 2
- 3 FIND WORD 3
- 4 FIND WORD 4
- 5 FIND WORD 5
- 6 GOTO STEP 3

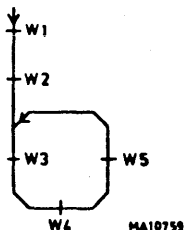

Fig. 4.3 Example of trigger on sequence break.

If the initial setting TRUE is desired, press the -> or V key to proceed.

-----FIND WORD-----
 1 1->2 1 OR 2 ----- END EDIT

The Find Word keys control the trigger word selection in this step.

- 1 = find word 1
- 1->2 = find word 1, immediately followed by word 2 (next clock sample; no matter which clock).
- 1 OR 2 = find word 1 or word 2 (this can be:
 - a Boolean relation:
 - find word 1 or find word 2,
 - or a conditional relation when combined with If ---- Then ---- statement.

END puts the END statement in the next step, after which the trigger output signal(s) can be selected, if required. The END statement is not selectable in the first step.

EDIT The sequence list is aborted from the cursor position downwards, permitting easy modification.

```

                -----LTA-----
DELAY  -----  -----  ENABLE  WAIT  NEXT  -----  -----

```

DELAY If this key is pressed, the delay value can be entered via the decimal keys of the hex key pad. After entering the delay value use the appropriate soft key key to obtain the unity of delay being selected.

ENABLE/WAIT LTA is the trigger-linkage function.

-ENABLE LTA The Logic State Analyzer enables triggering of the Timing Analyzer. This is selectable in the COMBI- as well as in the SYNC mode.

-WAIT LTA The triggering of the Logic State Analyzer is enabled by triggering of the Timing Analyzer (COMBI mode only).

NEXT initiates the next step in the sequence.

```

STATES OCCUR USEC MSEC SEC ----- ----- -----

```

If DELAY has been selected these softkey functions become available.

STATES The delay is a number of state clocks (0--65535). The clocks activated in the configuration menu or a combination of these clocks can be specified.

OCCUR The delay is by occurrences (0--65535) of a specific word. This word can be the same word as used in the trigger step itself, or word A.

USEC MSEC SEC Provide a delay in time. (0--999 for usec and msec; 0--65 for sec.)

```

-----ON CLOCKS-----
0      1      2      0+1      0+2      1+2      0+1+2      -----

```

Here you can select the clock(s) related to the earlier selected states delay.

Note that the '+' sign means a logic 'OR'.

```
-----IF WORD-----
 2      2->3  2 OR 3  -----  -----  NEXT  -----  -----
```

Gives the possibility to check for 1, or 2 or an immediate follow of two words, combined with the delay function. If key NEXT is pressed the next trigger step is initiated, and we just have a simple form of delay.

```
-IN--  -AT--
DELAY  DELAY  -----  -----  -----  -----  -----  -----
```

Here you can extend the trigger delay function. The above trigger word(s), or combination of words can be selected to be found during the delay, or at the end of the delay. Pressing either of these, results in the appropriate soft key text, being entered into the trigger sequence plus the prompt 'THEN STEP'. Following this we must enter the step number to which we require the trigger sequence to branch to, if the 'IF...THEN' condition is met. Upon entering entering this step number via the hex pad the soft keys respond with the following:

```
ELSE
STEP  -----  -----  -----  -----  NEXT  -----  -----
```

If the NEXT key is pressed, a new step is generated. In addition the instrument assumes that, if the 'IF...THEN' condition is not fulfilled, the trigger sequence should continue from this new step number. Should we not require this, then use of the 'ELSE STEP' key enables free definition of the step number at which the trigger sequence should continue.

Up to now we completed an example of a rather extended trigger step. Try other trigger functions for your self.

Timing trigger menu

```

          TIMING TRIGGER MENU

TRIGGERMODE  WORD

          EXT CHAN
          76543210
TRIGGER OCCURS AT  WORD X 00001111 VALID > OR = 200 nSEC

TIME DELAY      2    nSEC
FINAL DELAY     127  TRANSITIONS

```

```

PRE  CENTER  POST  _____

```

Fig. 4.4 Timing Trigger Menu

The main functions in this menu are, from top to bottom:

```

**TIMING TRIGGER MENU**
-TRIGGER MODE

-TRIGGER OCCURS AT

-TIME DELAY

-FINAL DELAY

```

Triggering can be done with the aid of a trigger word, a glitch, and a trigger window. The trigger word includes the external trigger /trigger qualifier.

The trigger glitch can be selected on one channel; the trigger bit on that channel in the trigger word is then automatically switched off.

Note that with glitch triggering, triggering occurs at the trailing edge of the glitch.

TRIGGER MODE

The following main trigger modes are selectable here:

```

-WORD
-GLITCH IN WORD
-GLITCH IN WINDOW

```

If glitch triggering has been selected, the glitch-line appears in the trigger menu.

TRIGGER OCCURS AT/AFTER ---

Five different trigger functions are possible:

1) AT WORD

Triggering occurs when the trigger word has been true for at least the selected valid time.

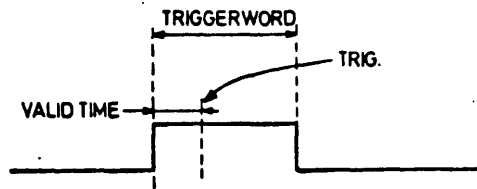

2) AFTER WORD

Triggering occurs at the trailing edge of the trigger word, if this word has been true for at least the valid time.

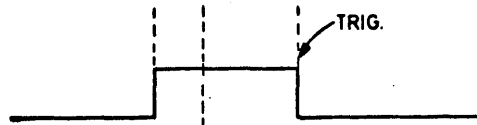

3) AT WORD AND GLITCH

Triggering occurs when the trigger word has been true for at least the valid time, and a glitch is present in the remaining time of the word.

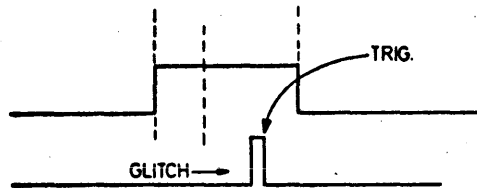
4) AT WORD AND GLITCH
IN WINDOW

Triggering occurs when the trigger word has been true for at least the valid time, and a glitch has been present in the following window.

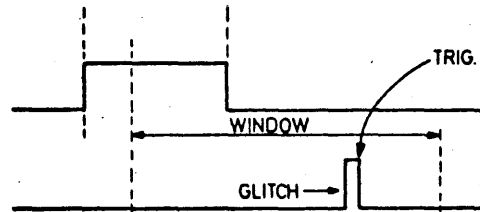
5) AFTER WORD AND
GLITCH IN WINDOW

Triggering occurs when the trigger word has been true for at least the valid time, and a glitch has been present in the window following the trailing edge of the trigger word.

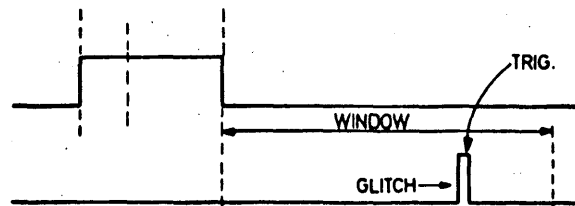

MA10746

Of course you noticed already that the glitch valid time could be set at a higher value than e.g. the word valid time. In this case triggering occurs if the trailing edge of the glitch is present in the remaining time of the trigger word.

The same applies also for glitch in window triggering.

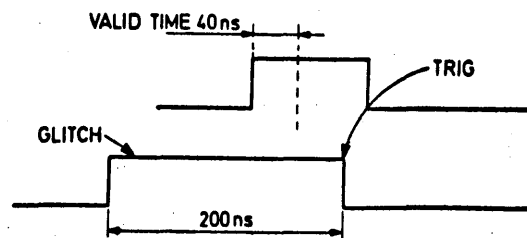

To be exactly, note that the glitch triggering in the timing display is as shown in next figure.

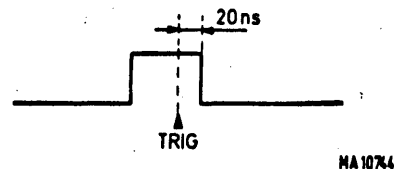

MA1074

EXT

Next thing you can select is the external trigger qualifier. This signal can be a 0, 1, or X.

CHAN

The eight bits of the trigger word are displayed here. Each bit (except those bits which have been switched-off in the Configuration menu) can be set to a 0, 1, or X.

VALID > OR =

This is the valid time setting for the trigger word (and the qualifier).

The trigger condition must be true for at least the selected time. In this way you can suppress erroneously triggering due to parasitic glitches.

If the glitch triggering has been selected, also the 'glitch line' is displayed.

The trigger glitch can be selected on one of the timing channels.

VALID < OR =

This is the valid time setting for the trigger glitch.

Glitches which are longer than the selected time are neglected. Note that the capture mode effectively prelongs a glitch shorter than 20ns to 20ns.

The next line shows:

TIME DELAY if you have selected trigger on WORD or GLITCH IN WORD, or TRIGGER WINDOW if you have selected GLITCH IN WINDOW. The time is selectable via the decimal keys of the hex keyboard (max. approx. 20 mS).

-TIME DELAY

This is the delay between presence of the trigger condition and the start of the final delay.

-WINDOW

This is a time window during which a trigger glitch can be detected. This window opens at the end of the valid time of the trigger word, or at the trailing edge of the trigger word (AT or AFTER respectively). Triggering occurs if during this time window a glitch of less than the specified length occurs.

The last line shows:

FINAL DELAY

This is the delay which gives pre-, center- or post data with respect to the end of the Time Delay.

The final delay can be set with the softkeys PRE, CENTRE and POST, or can be set to any value between 0 and 255 with the decimal keys of the hex keyboard.

- PRE : The memory of the timing analyzer is filled with data present just before the end of the time delay (delay=25).
 CENTRE : The memory is filled with data 'centered' before as well as after the end of the time delay (delay=127).
 POST : The memory is filled with data appearing just after the end of the time delay (delay=230).

If pre- or post trigger data setting is selected via the softkeys, a default overlap of 25 transitions is used.

Refer to Fig. 4.5.

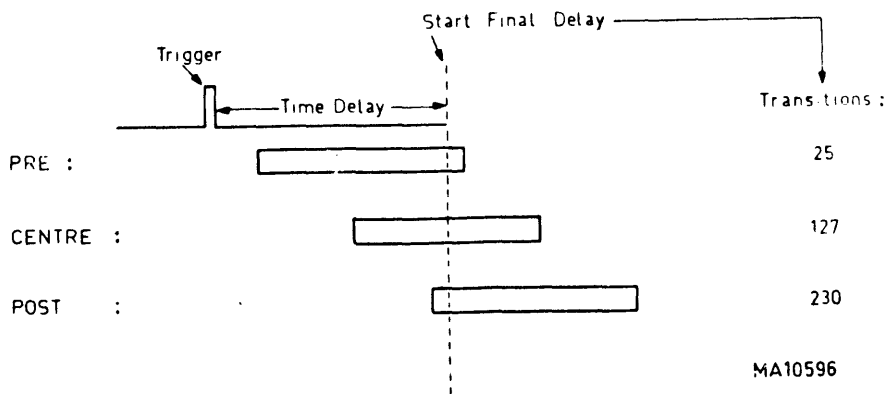

Fig. 4.5 Time Delay and Final Delay

4.1.3 DATA MENU

Press the FULL- and the DATA key in the MENU area.
If you had selected a stored mode before, the data menu will be as it was stored.

```

          DATA ACQUISITION MENU

DATA SELECTION:BLOCK 1+2 ON
1.CAPTURE :CLOCKS 0
SAMPLE FROM:WORD 1          TO:WORD 2
2.CAPTURE :CLOCKS 1
SAMPLE FROM:WORD 2          TO:WORD 5 + DELAY
COUNTER   :ON
COUNT    :TIME
START AFTER:WORD 1
FINISH AT :WORD 2

WD CLK AAA BBBB CCCC DDDD EEEE FFFF GGGG 0 F
A 0 XXX XXXX XXXX 0020 X T
B 0 XXX XXXX XXXX 0040 X T

1 0 XXX XXXX XXXX XXXX X T
2 0 7E6 021C 4C00 22FF X T
3 1 00438 4C66 00FF X T
4 1 00438 3A67 F4FF X T
5 0 7E6 021C 4412 10FF X T

-DELAYED EDGE- -DELAYED LEVEL- -NOT DELAYED-
f 3 1 0 H L X

```

Fig. 4.6 Data Menu

Now the SELECTIVE DATA ACQUISITION MENU is on the display.

This menu has two functions:

1. Selection of data which will be stored in the Analyzer's memory.
2. Enabling of a counter which counts the number of specific samples (word- or clock related), or the time between two selected words.

Both functions may be enabled at the same time.

Note that this menu applies only to the State Analyzer, and works in both the trigger sequence true- and trigger sequence break modes.

The data menu is divided in 3 main fields, from top to bottom:

```

**SELECTIVE DATA ACQUISITION MENU**
- DATA SELECTION: (BLOCK1)
                  (BLOCK2)

-COUNTER: ---

- WORDS LIST
-
-

```

DATA SELECTION can be switched on or off.

DATA SELECTION means making a selection of the data to be stored in the Analyzer's memory.

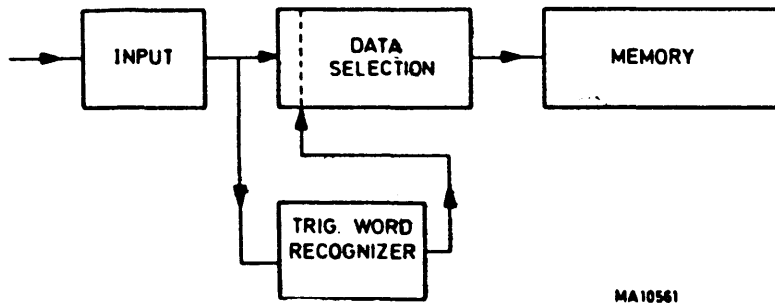

Fig. 4.7 Principal Block Diagram Data Selection

Data selection is very useful, when collecting certain groups of data from a program run, e.g. jump routines in a repetitive loop.

Selective data acquisition is effective in so-called blocks; two different blocks can be defined at the same time. The blocks are numbered with 1 and 2.

Four kinds of selective data acquisition are possible:

ONLY CLOCKS

-Only samples on specified clock(s)

WORD AND CLOCKS

-Only words A or B and samples on specified clock(s)

ONLY WORDS

-Only words A or B

WORD A + DELAY

-Only words A followed by a certain number (1--255) of samples on the specified clock(s). This number of samples is the same for both blocks.

REPEAT This combination may be repeated a number of times (1--512).

ALWAYS The word A +delay capture combination runs continuously up to the end.

Some restrictions on the use of words A and B in selective data acquisition:

Two or three items of the following list don't go together:

- Trigger on sequence break
- Selective data acquisition with word A and delay
- Selective data acquisition with word B

So only one of these three may be selected, otherwise one of the following error messages can be displayed:

- NOT A+DLY + BRK
- NOT WRD B + BRK
- NOT WD B+ A+DLY

Blocks are defined by a START and an END.

The start of a block can be:

- START, this is the start of data acquisition.
- WORD, this can be any of the words of the trigger menu.
- WORD+DELAY, this enables starting of data acquisition, when the delay counter following a specified word is fulfilled.

The end of a block can be:

- END, this is the end of data acquisition, so the final triggering.
END can be used if the block starts with START, or with a WORD .

- NEXT, this is the following event in the trigger sequence.
It can be the next word found, or the fulfilling of the following delay counter. Very usefull for conditional branches.

NEXT can only be selected if the block starts with a WORD.

- WORD, this is a word of the trigger list.
If for start a word has been selected, the number of the end word may not be lower than that of the start word.

- WORD+DELAY, a word can be followed by the delay coupled to that word in the trigger menu.

COUNTER

The counter is a function which can count samples or time between two defined points.

Counting can be specified as:

ONLY CLOCKS, the number of samples with the specified clock(s) will be counted.

WORDS+CLOCKS, only words A or B with the specified clock(s) will be counted.

ONLY WORDS, only words A or B are counted.

TIME, time measurement

The count result is indicated in the State List display.

The counter is only enabled in a window. This window is defined by a start and an end, and can be set as follows:

START AT can be specified by START, or by a word of the trigger list.

START is the start moment of data acquisition

WORD is one of the words of the trigger list.

WORD+DELAY is one of the words of the trigger list with the delay coupled to that word.

FINISH AT can be specified by END, NEXT, or WORD.

END is the end of data acquisition (final triggering)

NEXT is the next word in the list.

WORD is one of the words of the trigger list.

WORD+DELAY is one of the words of the trigger list with the delay coupled to that word.

WORD LIST

This list shows the words as selected in the trigger menu with words A and B.

Words A and B serve as words to be counted.

Word B appears only if it is not used as word 7 in the trigger list.

Note that the trigger words as selected in the trigger menu cannot be changed in the selective data menu.

For selection of the words A and B and the belonging qualifiers refer to the trigger menu description.

4.1.4 COMPARE MENU

Press the FULL- and the COMPARE key in the MENU area.

```

          COMPARE MENU
    IF AUTO THEN:SPEED IMMED
          :STOP ON COMPARE EQUAL

          STATE SECTION:ON

    COMPARE LABELS :
    AAA BBBB CCCC DDDD EEEE FFFF GGGG
    COMPARE BLOCK  :FROM CUR MEM/LIN# +40 TO +200
          :REF MEM/LIN# +44
    COMPARE CLOCKS :0

          TIMING SECTION:OFF

AAA BBBB CCCC DDDD EEEE FFFF GGGG

          ONLY CLOCK-
0+1+2  0  1  2  0+1  0+2  1+2  _____

```

Fig. 4.8 Compare Menu

Now the Compare menu is on the display; we have now the possibility to compare two blocks of data.

One block is current data (stored in the acquisition memory), the other block is data in the reference memory of the analyzer.

Comparison can be done for data in the state section as well for data in the timing section, and can be done in both the manual- and the auto start mode.

Note that also comparison is possible in the COMBI- and SYNC modes.

The main functions in the compare menu are:

****COMPARE MENU****

-IF AUTO THEN :--

-STATE SECTION :--

-TIMING SECTION:--

IF AUTO THEN :

The auto restart display time is adjustable here. This is the time between final triggering, and the start of the next data acquisition. You can adjust this time between 1...9 sec, or IMMEDIATE. With Immed the maximum compare frequency rate is obtained.

Note that this setting is not only applicable in the Compare mode, but also in the non-compare auto mode.

In the Auto Compare mode the following functions are selectable:

-STOP ON COMPARE EQUAL

Data acquisition and comparison continue until an equal compare has been found.

-STOP ON COMPARE NOT EQUAL

Data acquisition and comparison continue until an unequal compare has been found.

-COUNT FAILURES AND SUCCESSES

Data acquisition and comparison continue until you press the STOP key. In the meantime the numbers of FAILURES (unequal-comparisons) and SUCCESSES (equal comparisons) are counted. The results are presented in the data display.

STATE SECTION :

This function can be switched on or off.

COMPARE LABELS:

Gives the possibility to select which labels, must be compared. Selection of the labels is done with the soft keys.

COMPARE BLOCK:

With this function you can define the blocks in the current- and reference memory which must be compared.

Note that thanks to the versatile compare features, data blocks in different areas of both memories can be compared, refer to Fig. 4.10.

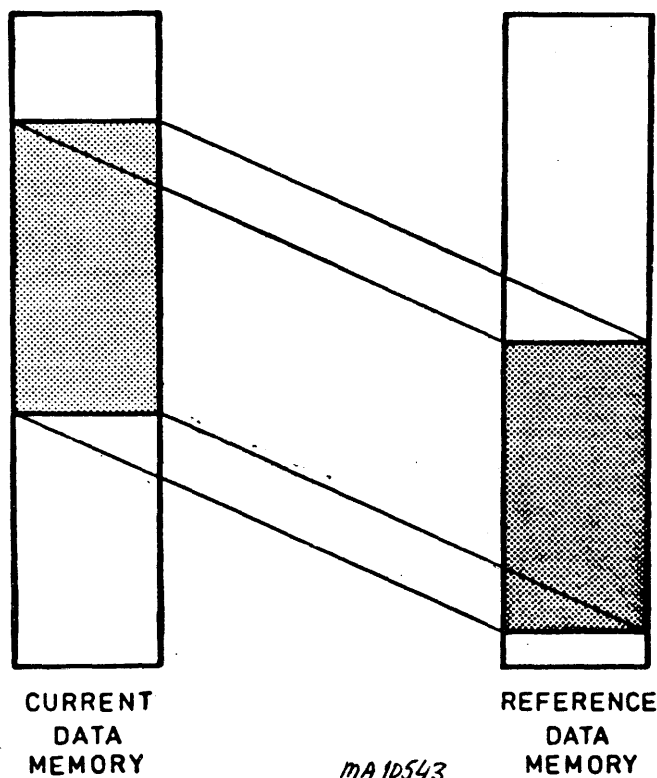

Fig. 4.10 Comparison of shifted memory blocks

In this case a line number, or a word number limit specification is required.

The beginning of a block can be defined with:

- MEM/LINE# this may be any number between -1023 and +1023.
- TOP this is the beginning of the memory.
- WORD this is a word of the trigger list.

The end can be defined with:

- MEM/LINE# this may be any number between -1023 and +1023.
- BOTTOM this is the end of the memory.
- WORD this is a word of the trigger list. The word number must be higher than that of the word defining the start of the block.

When MEM or LINE numbers have been entered, the compare function searches for MEM or LINE numbers which are present in both memories. So a lower number may be entered to point to the beginning of a block, and a higher number may be entered to point to the end of a block. Compare from MEM or LINE# -1023 to MEM or LINE# +1023 is possible.

Compare from TOP to BOTTOM can be used if the start of data acquisition is fixed; e.g. with selective data acquisition starting from WORD1. If also pre-trigger data might be present in the memory, compare from top to bottom is not recommended because the start of data acquisition generally is not fixed.

The block length of the reference memory is always the same as the length of the current memory block.

Depending on the selected current memory limits, the reference memory limits are generally specified as SAME. In case VAR has been selected, a MEM/LINE# in the reference memory can be specified as start of the reference memory block.

Line number off-set and cursor displacement

It stands to reason that reference data and current data must be sampled with the same instrument setting such as trigger word, delay, etc.

However if data have been sampled with different trigger delay, note that the following may happen.

In this example we assume that the trigger delay was 200 in the reference data, and 300 in the current data; we want to compare current data line numbers -10 to 10, with reference data starting with line number 0.

After comparison we select successively Current-, Reference-, and Compare display as indicated in Fig. 4.9.1--3. If screen overflow occurs in Compare display select hex label base.

First (Fig. 4.9.1) we select the Current display with the cursor on TRIG.

When we select now the Reference data display, note that the cursor position is at 10 (this is because current line -10 was compared with reference line 0, so current data line TRIG (=0) corresponds with reference line 10).

When we select now the Compare display, we will see the combination of the former two displays. In the current list the unequals are displayed in reverse video. Line numbers 11 and 12 of the current list show no unequals, and line numbers 21 and 22 in the reference list are not displayed, because they were not included in comparison.

Next we go back to Current display and put the cursor at e.g. 100 (refer to Fig. 4.9.2). Switching-over to the Reference display, we'll find line number 110 in the top of the list (this is the same difference as in Fig. 4.9.1).

In the Compare display we don't find any unequal in the current list, and no data in the reference data at all (these sections of the memories have not been compared).

In the last example (Fig. 4.9.3) the cursor displacement is shown. Assume we select the Current display and put the cursor at line number 288. Line number 288 to 300 incl. are displayed.

When we now select reference display we will see line numbers 188 to 200 incl. on the display. Did you expect line numbers 298 to 310?

Because the trigger delay for the reference data was only 200 (see above), line number 200 is the last line in the reference display.

When we switch back to the Current display we will now find line numbers 178 to 190 incl., so due to the difference in the number of post-trigger lines the cursor has been displaced.

The same phenomena of cursor displacement will appear when switching over from Current display to Reference display and vice versa.

COMPARE CLOCKS

It is also possible to select samples for comparison by their clocks.

STATE COMPARE PRINCIPLE

After the compare function has been started, the analyzer searches for an unequal in the memories, starting from the beginning of the sections to be compared. As soon as an inequality has been found, the message NEQ is displayed, and the analyzer starts the data list display routine.

If no inequality is found, the compare function runs up to the very last character at the end of the sections to be compared. Next the EQ message is displayed, and the data list display is started.

Note that it may take a considerable time to compare memories to the full extend (from line 0 to 1022 over 35 channels may take up to 57 sec.).

So it is quite handy to delete data for compare, in which you are not really interested.

Note that in SW rel. 1.0 and 1.1 automatically a compare is executed after pressing the Store Data key. This costs time, because then two memories with the same contents are compared.

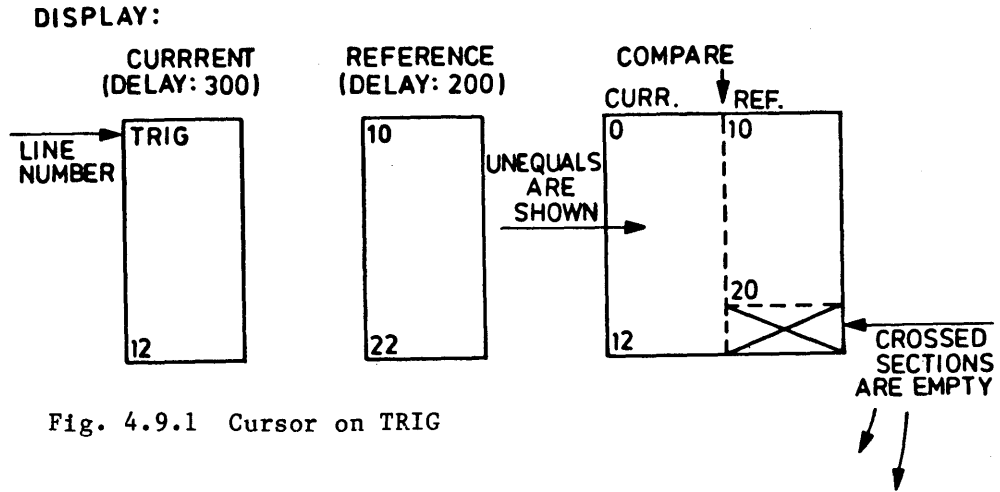

Fig. 4.9.1 Cursor on TRIG

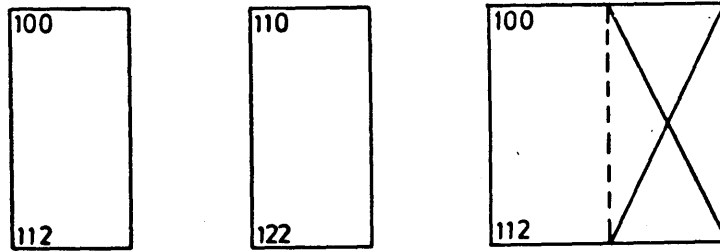

Fig. 4.9.2 Cursor on +100

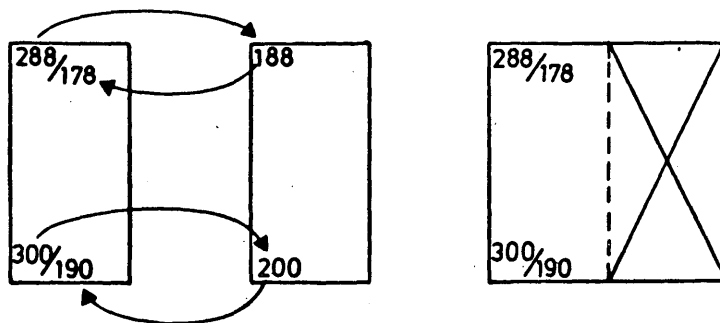

Fig. 4.9.3 Cursor displacement

MA10768

Fig. 4.9 List line or mem number off-set and cursor displacement examples with compare.

TIMING SECTION :

Can be switched on or off.

Refer to Fig. 4.10.1 and 4.10.2.

COMPARE CHANNELS

Each channel can be switched on or off for comparison.

:FROM TRIG

Time value of the beginning of the block to be compared with respect to the trigger point (+ or -).

:LENGTH

Time value of the length of the block to be compared.

:SKEW

This is the maximum time value of the allowed difference between a current edge and the corresponding reference edge (absolute value).

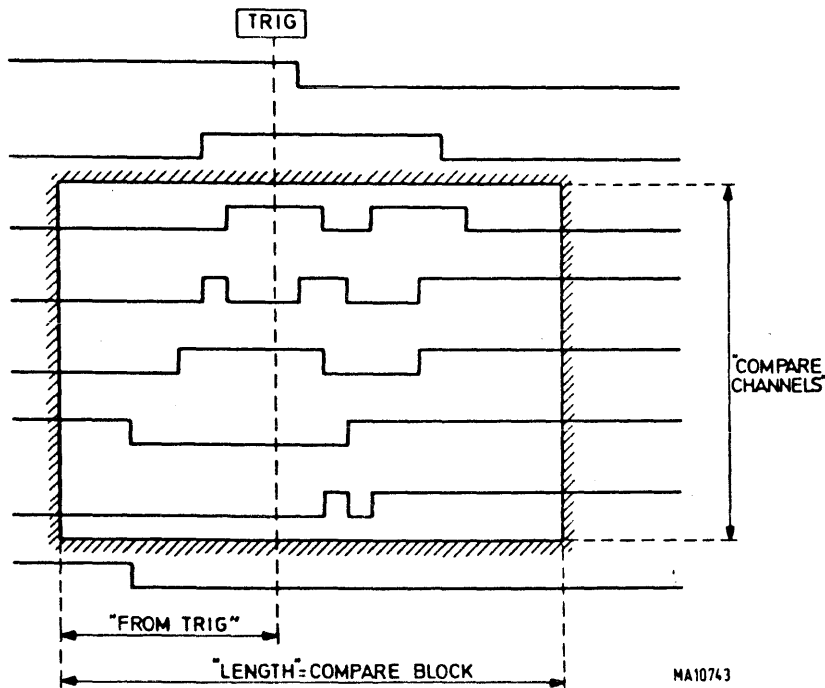

Fig. 4.10.1 Timing compare

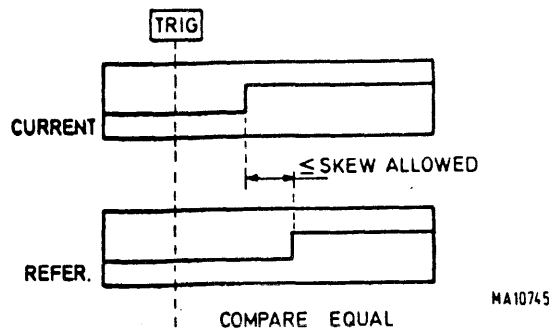

Fig. 4.10.2 Maximum allowed skew with timing compare

4.1.5 OPTIONS MENU

Press the OPTION key in the MENU area.

OPTIONS MENU

```

PRINTER -OFF
BAUD RATE-9600
SEND    -PAGE

```

```

DISASSEMBLERS
A-PACKAGE MOTOROLA
- 280      - 6800
- 8085     - 6809
- 68000    ■ 68000

```

```

  OFF ON _____

```

Fig. 4.11 Options Menu

Now the options menu is on the display.

The main sections of this menu are:

****OPTIONS MENU****

INTERFACE:

DISASSEMBLERS:

INTERFACE

The interface can be a:

- Printer interface
- RS232C control interface.
- IEEE 488 bus interface.

Printer:

The printer must be provided with an RS232C interface. The Baud-rate of the Logic Analyzer I/O can be set to the standard values from 110 to 9600.

The printer driver is controlled by putting the cursor at the PRINTER line and pressing the softkeys ON or OFF.

With the cursor at the BAUD RATE line the Baud rate can be set with the softkeys.

With the cursor at the SEND line, the following print-commands are selectable:

DISPLAY PAGE

The printer prints a copy of the analyzer's display.

ALL DATA

All data in the acquisition memory are send to the printer.

DATA+MENUS

The full instrument setting and the data in the acquisition memory are sent to the printer.

ALL MENUS

The full instrument settings are sent to the printer.

The print action is started by pressing the I/O CONTROL PRINT key.
The print action is halted by pressing this key again.

DISASSEMBLERS

A Disassembler is a program which converts the machine code of a specific micro processor into the corresponding assembly language. In fact a disassembler is similar to the resident processor micro-programms. Only a disassembler translates the machine code, where the micro processor executes the machine code. The disassembler program knows how to distinguish opcode from data.

Disassembler programs are located in various disassembler packages, as indicated below:

Disassembler Package:	Features
A	Most common micro processors
M	Motorola micro processors
N	Intel micro processors
Z	Zilog micro processors
R	Other micro processors and IEEE488/IEC625 disa

A disa package consists of a small p.c.board provided with some proms. Disa packages (max. 4) are located on the options board.

For detailed information such as installation, connection, etc. refer to chapter 9.

A disassembler program is selected by putting the cursor on the specific micro processor on the display, and pressing the activ ON softkey. This automatically sets the labels, base and logic in the configuration menu for the selected micro processor (check this).

Disassembler display:

The header of a LIST display shows the selected micro processor and the specific assembly functions such as:

- Status
- Address
- Data
- Mnemonics
- Operand
- Int

The following softkey functions are possible:

DISPLAY or DISPLAY
 FORMAT POSIT

The Display Format function permits control of the Blank, Recall and Invert functions.

The Display Position function permits control of the data cursor, such as Cursor, Find, Page+ and Page-.

For more information on the display control refer to chpt: List Display.

SYNC or SYNC
 AUTO MANUAL

A disassembler program requires micro processor status information to distinguish instruction code from data etc., otherwise correct disassembly is not possible.

Some types of micro processors (e.g. 8085) deliver sufficient status information; in this case the AUTO- and MANUAL SYNC softkeys are not activated.

With other micro processors, a selection can be made of Automatic Synchronization, or Manual Synchronization. See below.

SELECT or SELECT
 STATE DISA

If the Select State function has been selected the disassembly functions disappear from the display.

If the Select Disa function has been selected the disassembly functions appear on the display.

Manual Sync functions

Select the Disassembler program in the Options menu.

Start a single shot data acquisition (no selective data, nor compare data activated).

Depress Sync Manual.

Depress Select Disa.

The disassembler presumes that the upmost line of the data list is an instruction, or the first byte of an instruction, and takes this line as a sync reference for the disassembler program.

Depress Display Format.

The disassembler program is now in the Retain Sync mode, this means that when scrolling or paging the data list on the display, the original sync reference remains. (note that the softkey shows Set New Mansync, this means that the disassembler is in the Retain Mansync mode).

Data lines before the sync reference can not be disassembled.

If now the Set New Mansync key is depressed, (the key shows Retain Mansync) the sync reference is always the upmost line of the data list. Each time after scrolling or paging, the upmost data line is automatically taken as a new sync reference.

When a disassembler has been selected the configuration is automatically set for the specific micro processor.

Normally this configuration need not to be changed. However the configuration can be adopted to met special requirements.

To this end, after selection of the disassembler you can switch back to the configuration menu and change e.g. clocks or qualifiers. The labels however cannot be changed.

For full details on specific micro processor disassemblers, connection, etc. refer to chapter 9.

SETTING MEMORY

This is a non-volatile memory which stores up to four different instrument settings. This memory consists of a small p.c. board provided with some EEPROMs, and is located on the I/O and Options board; refer to ???

Note that there is a STORED and a SAVED softkey in the Configuration menu. For directions for use refer to the description of the Configuration menu.

4.2 CONDENSED MENUS

GENERAL INFORMATION

A condensed menu is meant as a "quick reference guide" when you are looking at a data display, and contains the most important information of the corresponding full menu.

There is a condensed menu for each available full menu (except the option menu).

A condensed menu is displayed in the upper six display lines, above the data.

Generally settings present in the condensed menu can be changed by pressing the Cursor in Heading key, positioning the cursor, and entering the desired setting.

The menu name is always in the centre of the top line.

The top left corner locates the operator warnings, such as:

INVALID KEY, OVERRANGE, etc.

The right top corner is reserved for the acquisition message.

Direct after start of acquisition the message: ACQUISITION STARTED is given.

In the following descriptions is presumed that one of the keys LIST, GRAPH, or TIMING has been depressed.

CONDENSED CONFIGURATION MENU

Press the CONFIG key.

```

          CONFIGURATION MENU
        CLK0=f ABCD... CLK1=f ...EFG CLK2=OFF
FORMAT 0A BBBB CCCC DDDD EEEE FFFF GGGG
LOGIC  POS POS  POS  POS  POS  POS  POS
BASE   HEX HEX  HEX  HEX  HEX  HEX  HEX
LIST CURRENT STATE   COUNTER = 197  μSEC
MEM # 00 BBBB CCCC DDDD EEEE FFFF GGGG
2 377                03FF 0012 08FF
2 378                03FF 0002 08FF
2 379                03FF 0002 08FF
2 380                03FF 0002 08FF
2 381                03FF 0032 08FF
2 382                03FF 0002 08FF
2 383                03FF 0012 08FF
2 384                03FF 0002 08FF
2 385                03FF 0072 08FF
2 386                03FF 0002 08FF
2 387                03FF 0072 08FF
2 388                03FF 0002 08FF
2 389                03FF 0012 08FF

      LABEL
BLANK INU RECALL CURSOR FIND NEXT PAGE+ PAGE-

```

Fig. 4.12 Condensed Configuration Menu

The top line of the condensed menu shows which clocks have been activated, and the corresponding channel labels.

The three remaining lines show the display format, -logic and -base of the input data.

CONDENSED TRIGGER MENU

Press the TRIG key.

Remember that in the Combi mode pressing this key, consecutively displays the State-, and the Timing trigger menu.

Condensed state trigger menu

```

STATE TRIGGER MENU
W2 0 7E6 021C 4C00 22FF
W3 1                021C 4C66 00FF
W4 1                021C 3A67 F4FF
W5 0 7E6 021C 4412 10FF
FINAL DELAY = 1000 STATES OF CLK 0+1
LIST CURRENT STATE COUNTER = 197 #SEC
MEM # 400 03FF 0012 08FF
2 377                03FF 0012 08FF
2 378                03FF 0002 08FF
2 379                03FF 0002 08FF
2 380                03FF 0002 08FF
2 381                03FF 0032 08FF
2 382                03FF 0002 08FF
2 383                03FF 0012 08FF
2 384                03FF 0002 08FF
2 385                03FF 0072 08FF
2 386                03FF 0002 08FF
2 387                03FF 0072 08FF
2 388                03FF 0002 08FF
2 389                03FF 0012 08FF

```

L LABEL I INV R RECALL C CURSOR F FIND N NEXT P PAGE+ P PAGE-

Fig. 4.13 Condensed State Trigger Menu

The triggerwords are displayed with active clock edge, and triggerword false or true indications.

Maximum four triggerwords are displayed.

If you selected more than four triggerwords in the full triggermenu, only the last four words are displayed here.

With the cursor up and down keys the remaining trigger words can be scrolled visible.

If a final delay (this is the delay after the last trigger word) has been selected, it is also displayed here.

The word in the top line of the data list can be copied in the trigger words in the condensed menu.

-Put the cursor in the heading (this is the condensed menu).

-Set the cursor on the desired word in the condensed menu. If required use the scroll function to obtain another word in the trigger list.

-Press the STORE TRIGW key.

Condensed timing trigger menu

Fig. 4.14 Condensed Timing Trigger Menu

As an exception the condensed timing trigger menu shows all the timing trigger parameters.

The first line shows the Trigger Mode.

The second line shows the Trigger Qualifier, the Trigger Word and the minimal time (Valid For) during which the trigger condition must be true.

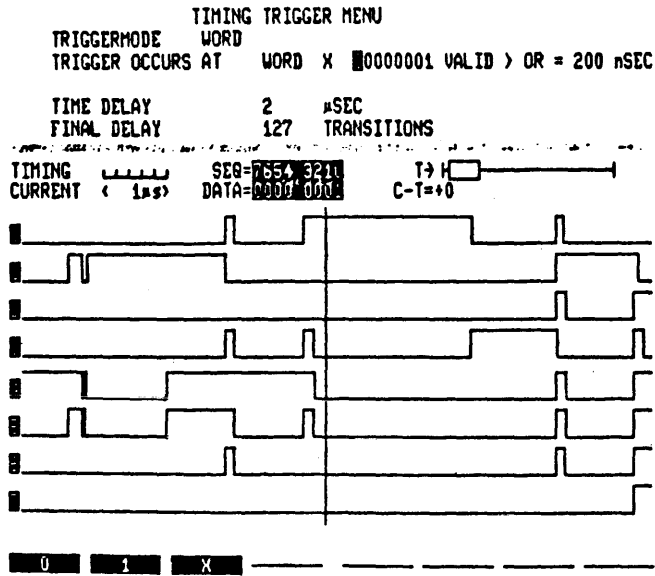
The third line (if present) shows the active channel glitch detection, with the selected valid time.

The next line shows the Time Delay, or the Time Window

The last line shows the Final Delay.

CONDENSED DATA MENU

Press the DATA key.

```

          DATA ACQUISITION MENU
DATA SELECTION: LOCK #1 ON
1.CAPTURE   :CLOCK 0
  SAMPLE FROM:WORD 1      TO:WORD 2
2.CAPTURE   :CLOCK 1
  SAMPLE FROM:WORD 2      TO:WORD 5 + DELAY
LIST CURRENT STATE   COUNTER = 197  μSEC          TRIG
MEM # 000-0000-0000-0000-0000-0000-0000-0000
2 377          03FF 0012 08FF
2 378          03FF 0002 08FF
2 379          03FF 0002 08FF
2 380          03FF 0002 08FF
2 381          03FF 0032 08FF
2 382          03FF 0002 08FF
2 383          03FF 0012 08FF
2 384          03FF 0002 08FF
2 385          03FF 0072 08FF
2 386          03FF 0002 08FF
2 387          03FF 0072 08FF
2 388          03FF 0002 08FF
2 389          03FF 0012 08FF

  ACTIVE BLOCKS
  OFF  1  2  1+2

```

Fig. 4.15 Condensed Data Acquisition Menu

If data selection was enabled, the related block limits and captured samples are given here, in the same lay-out as in the full menu.

The counter setting is not shown in the condensed data selection menu.

CONDENSED COMPARE MENU

Press the COMP key.

```

          COMPARE MENU
        STATE SECTION:ON
AAA-655B-CCCC-0000-FFFF-FFFF-6666
COMPARE BLOCK :FROM CUR MEM/LINEN +40 TO +200
               :REF MEM/LINEN +44
COMPARE CLOCKS :0
LIST CURRENT STATE  COUNTER = 197  μSEC          TRIG
MEM # AAA-655B-CCCC-0000-FFFF-FFFF-6666
2 377              03FF 0012 08FF
2 378              03FF 0002 08FF
2 379              03FF 0002 08FF
2 380              03FF 0002 08FF
2 381              03FF 0032 08FF
2 382              03FF 0002 08FF
2 383              03FF 0012 08FF
2 384              03FF 0002 08FF
2 385              03FF 0072 08FF
2 386              03FF 0002 08FF
2 387              03FF 0072 08FF
2 388              03FF 0002 08FF
2 389              03FF 0012 08FF

          LABEL
BLANK INV RECALL CURSOR FIND NEXT PAGE+ PAGE-

```

Fig. 4.16 Condensed Compare Menu

Condensed state compare menu.

This menu shows:

State section: ON

The block limits in the current memory as well as in the reference memory.

The clocks to be compared.

5 D E S C R I P T I O N O F T H E D A T A D I S P L A Y S

5. DATA DISPLAYS

There are two groups of data displays:

- List display
- Timing display (only with versions PM 3551/30/70)

The List display represents data from the Logic State Analyzer.

The Timing display shows data from the Logic Timing Analyzer.

Each data display is accompanied with a condensed menu, located at the top of the data display. For description of the condensed menus refer to chapter 4.2.

The display is divided in the following sections, from top to bottom:

(Error Message)	Menu Name	(Run)
	Condensed Menu	
	----- Data Display Heading -----	trig/man
	-	
	-	
	-	
	Data Display	
	-	
	-	
	-	

The menu name is always in the centre of the top line.

The top left corner locates the error messages, such as:

INVALID KEY, OVERRANGE, etc.

The right top corner is reserved for the acquisition message.

Direct after start of acquisition the message: ACQUISITION STARTED is given.

If the CURSOR IN HEADING key has been depressed, settings in the menu can be changed.

If the CURSOR IN DATA FIELD key has been depressed, control is given over the displayed data.

A specific data display is always selected by pressing the relevant key in the DATA DISPLAY area.

The source for the data display can be selected with the keys:

CURRENT which displays the data from the current memory

REF which displays the data from the reference memory

COMPARE which displays data from the current memory, and compares it with the reference memory data.

Inequalities are indicated by reversed video presentation in the LIST, and underling in the TIME display. There is no GRAPH compare display.

In the following description of the displays, keys CURSOR IN DATA FIELD and CURRENT have been depressed.

5.1 LIST

Press the LIST key.

```

                                STATE TRIGGER MENU
W1 0 7E6 021C 4A66 0000
W2 0 7E6 021C 3A11 4000
W3 1                                03FF 0012 0800

FINAL DELAY = 1000 STATES OF CLK 0+1
LIST CURRENT STATE COUNTER = 1.6 #SEC TRIG
LINE # 000-0000-0000-0000-0000-0000-0000-0000
516 7E6 021C 3A11 4000
517 7E6 021C 2E61 0000
518 7E6 021C 3000 1400
519 7C5 0006 8C00 0200
520 7C5 0006 8E1C 3200
521 7E6 021C 4412 1000
522 7E6 021C 4602 0100 03FF 0002 0800
523 7E6 021C 4800 1000
524 7E6 021C 4A66 0000
525 7E6 021C 4C00 2200
526 7E6 021C 4E4E 7500
527 7E6 021C 5012 1000
528 7E5 0006 8C00 0200

```

Fig. 5.1 Data List Display

List heading

The heading of the list display contains the following information:

```

LIST CURRENT STATE
MEM OR LIN NO < Selected Labels >
LIST           : The name of the display
CURRENT,
REFERENCE or
COMPARE       : The source of the displayed data.
STATE        : Means State list.
OLD          : Is shown if settings have been changed after
              acquisition.
MEM or LIN NO : Memory address number or line number.
              This is the sequential numbering of the samples in
              the memory.
              MEM NO is used if the trigger word is not in the
              memory. E.g. final delay greater than 1023 samples.

```

LIN NO indicates that the trigger word is in the memory and gives the relation between the sample number and the trigger word. The trigger word itself has number 0, but is indicated with TRIG. Forgoing trigger words (arm words) are indicated as WRD1, WRD2 etc. Samples before the trigger word have a '-' number; samples after the trigger word have a '+' number.

Label line This line shows the labels as selected in the configuration menu.
With the cursor in the heading, labels can be deleted or recalled, or the value can be inverted (refer to the LABEL soft keys). See below.

List display

Data is represented under the selected labels, according to the selected base, polarity, etc.
The list is generally 13 lines long; the top line is the data cursor line.

The data cursor line is used as a reference between the list display and the timing display in the sync mode, and the graph display, in which the data cursor is a vertical solid line.

If no data are present in the memory, the list display is empty.

List set-up

The data list set-up is depending on the relation between clocks and labels as selected in the configuration menu.

If each label is sampled with a specific clock, the successive clock number samples will be displayed next to each other (parallel display). Refer to the following two examples:

CONFIG. MENU	LIST DISPLAY		
1)			
CL 0 label A	A	B	C
CL 1 label B	CL 0	CL 1	CL 2
CL 2 label C	-	-	-
	-	-	-
	-	-	-
2)			
CL 0 label C	A	B	C
CL 1 label B	CL 2	CL 1	CL 0
CL 2 label A	-	-	-
	-	-	-
	-	-	-

Note that a clock 0 sample always starts a new line of the table.
A clock 1 sample is positioned on the same line when it follows the clock 0 sample. In the same way a clock 2 sample is put on the same line when it follows a clock 1 or a clock 0 sample.

If no clock 0 sample is present, a clock 1 sample can start a new line. If no clock 0 and no clock 1 samples are present, a clock 2 sample starts a new line.

On the other hand, channels sampled by different clocks but with the same label, will be displayed under the same label without any further clock indication (serial display).

As there is no direct time relation between two successive lines of the data list, there is also no time relation between samples with different clocks on the same line. However the minimal time here is longer than one clock cycle.

April 20, 1983

Softkey functions

With the cursor in the DATA FIELD the following softkeys are shown:

```

----- LABEL -----
BLANK INV. RECALL  CURSOR FIND NEXT  PAGE+ PAGE-

```

The LABEL functions control the presentation of the channels or groups as shown in the List heading. Pressing the BLANK key blanks the related column of data, resulting in information being deleted from the screen and replaced by a column of points.

The label-character is replaced by a dash.

With the RECALL key the column of data can be recalled.

The INV. softkey inverts the value in the related column; the label is now shown as a undercase character. If this key is pressed again the non-inverted values come back. Also if RECALL is pressed on an inverted column, the non-inverted values come back.

The next group: CURSOR, FIND, NEXT, PAGE+, and PAGE- controls the data cursor as a viewing-aid over the memory. Soft scroll of the list is possible with the CURSOR SCROLL keys.

The top line of the displayed data list is the cursor word.

The NEXT softkey is only activated if a specific cursor word has been selected.

With the PAGE+ and PAGE- softkeys the cursor can be paged through the memory (this is + or - 13 lines respectively).

Pressing the CURSOR softkey shows the following softkey labels:

```

-----
-----
-----
-----
-TOP-  BOTTOM  ENTER  ABORT

```

Pressing TOP shifts the data list in such a way that the first memory address appears on the top line of the list on the display.

Pressing BOTTOM shifts the data list such that the last memory address appears in the bottom line of the list of the display.

Also a line number can now be given via the hex keypad, and entered by pressing the ENTER softkey. A line number may be preceded with a '+' or a '-' sign.

Pressing the DELETE key on the hex pad resets the line number you just typed before the ENTER softkey is pressed.

Pressing the ABORT softkey resets the cursor functions; the display remains unchanged.

On pressing the FIND key the following soft key functions are shown:

```

-----
-----
-----
MEM
CONT  TRIG  WORD  -----  ABORT

```

Pressing MEM CONT enables the entry of a user defined word via the hex pad.

After pressing MEM CONT the following softkeys are activated:

```

-----
-----
-----
-----
-----
COPY   ENTER   ABORT

```

Instead of the channel label indication above the data list, now a row of dots is shown. The memory contents to be searched can now be selected.

Note that there is a difference between a . (dot) and an X (don't care).

-A . (dot) can be data or a space.

-An X (don't care) is only data.

The memory contents can be selected via the hex pad, also the . and the X. In ASCII only the . and X are functioning.

By pressing the COPY softkey, the memory contents in the top line of the data list on the display is copied.

Or a value can be entered via the hex key pad and pressing the ENTER softkey.

Pressing the ABORT softkey resets this input.

Instead of using the MEM CONT function, also the TRIG softkey can be pressed. This shifts the data list such, that the trigger word comes in the top line of the data list.

The third possibility is by pressing the WORD softkey. Now one of the words as selected in the trigger sequence list, can be selected to appear in the top line of the list on the display.

The NEXT softkey functions if a Mem Contents, or one of the words of the trigger list has been selected.

By pressing the NEXT softkey the next selected memory contents or word appears in the top line of the data list on the display.

The NEXT function remains active until labels have been changed in the Configuration menu.

The NEXT function works for both the current- and the reference memory.

When the Compare Display has been selected, the NEXT softkey puts the next unequal comparison line in the top of the list. If there are no unequals the NEXT softkey is not activated.

The NEXT function steps wrap-around through the memory for selected memory contents, or a word; or unequal comparisons in compare display.

Cursor functions

SCROLL UP, SCROLL DOWN These functions feature soft scroll of the data list.

SHIFT <- and -> control the set cursor position.

5.1.1 SELECTIVE DATA DISPLAY

```

          DATA ACQUISITION MENU
DATA SELECTION:BLOCK 1+2 ON
1.CAPTURE   :CLOCKS 0
SAMPLE FROM:WORD 1      TO:WORD 2
2.CAPTURE   :CLOCKS 0
SAMPLE FROM:WORD 3      TO:WORD 4

LIST CURRENT STATE
LINE # 000000000000000000000000 TRIG
WRD1  7E6 021C 4A66 0000
1 -22 7E6 021C 4C00 2200
1 -21 7E6 021C 4E4E 7500
1 -20 7E6 021C 5012 1000
1 -19 7E5 0006 8C00 0200
1 -18 7E5 0006 8E1C 3200
1 -17 7E6 021C 3212 1000
1 -16 7E6 021C 3402 0100
1 -15 7E6 021C 3600 0200
1 -14 7E6 021C 3867 F400
WRD2  7E6 021C 3A11 4000
WRD3  7C5 0006 8C00 0200
2 -11 7C5 0006 8E1C 3200

      LABEL
BLANK INU  PECALL CURSOR FIND NEXT PAGE+ PAGE-

```

Fig. 5.2 Selective Data Display

After triggering the display shows the selected data blocks with indication 1 or 2 before each data line in the list.

If block 1 overlaps block 2, the indication 1 remains until the end of block 1.

In instruments of version D01 it is possible that some lines of data are displayed before the selected data blocks (skip these lines).

5.1.2 COMPARE DISPLAY

For comparison of data lists the following preparations are required:

-Store the reference data in the reference memory. This can be done by pressing the STORE DATA key by which data in the current memory is copied into the reference memory, or by storing external data via the I/O interface.

-Set the compare conditions in the state compare menu.

After pressing the DATA DISPLAY COMPARE key, both memories are compared and the result of the comparison is displayed.

```

          COMPARE MENU
        STATE SECTION:ON
AAA-BBBB-CCCC-DDDD
COMPARE BLOCK :FROM CUR TOP TO BOTTOM
               :REF SAME
COMPARE CLOCKS :0

LIST COMPARE STATE   COMPARED FROM MEM/LINE# -26 TO   0 TRIG
LINE # AAA-BBBB-CCCC-DDDD EE
-26 7E6 021C 4B00 1000   -40 7E6 021C 5012 1000
WRD1  7E5 021C 4B58 0200   -39 7E5 0006 8C00 0200
-24 7E5 021C 4C00 3200   -38 7E5 0006 8E1C 3200
-23 7E6 021C 4E4E 7E00   -37 7E6 021C 3212 1000
-22 7E6 021C 5012 1000   -36 7E6 021C 3402 0100
-21 7E5 0006 8C00 0200   -35 7E6 021C 3600 0200
-20 7E5 0006 8E1C 3200   -34 7E6 021C 3867 F400
-19 7E6 021C 3E1E 1000   -33 7E6 021C 3A11 4000
-18 7E6 021C 3402 0100   -32 7E6 021C 2E61 0000
-17 7E6 021C 3E00 0E00   -31 7E6 021C 3000 1400
-16 7E5 021C 3867 F400   -30 7C5 0006 8C00 0200
WRD2  7E5 021C 3A11 4000   -29 7C5 0006 8E1C 3200
-14 7E6 021C 3E5E 0000   -28 7E6 021C 4412 1000

OFF ON

```

Fig. 5.3 List display in the compare mode.

If no screen overflow occurs, both the current memory and the compare block of the reference memory are displayed. If screen overflow occurs, only the current memory is displayed.

Unequal bits or values are displayed in the current memory list in reverse video.

COMP is indicated in the list heading and the compare result EQ or NEQ is displayed.

Not-equal data will be displayed in reverse video.

State compare is also possible in the auto mode, featuring stop on compare equal or not equal, or continuously counting failures and successes.

5.2 GRAPH DISPLAY

Press the GRAPH key.

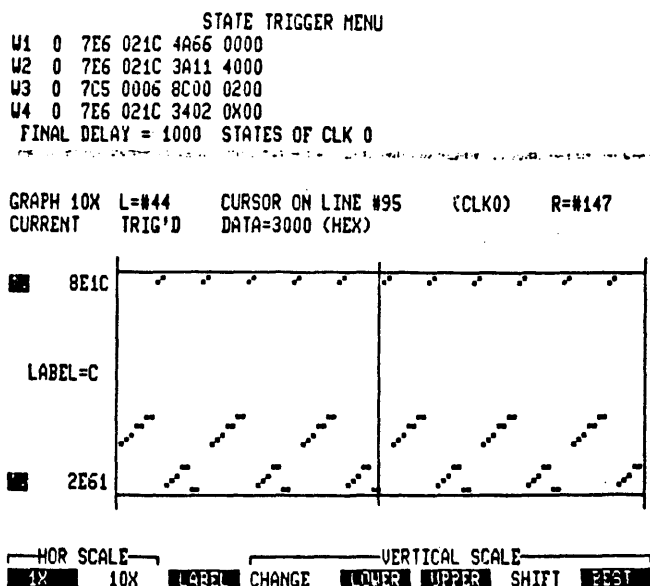

Fig. 5.4 Graph Display

A graph display gives a graphical representation of the contents of a specified label, of the state analyzer memory.

The label may not be wider than 32 channels (=FFFFFFFF_H), nor may the label-base be in ASCII.

The graphic display consists principally of dots. The vertical position of a dot represents an analogue value.

The values of the upper and lower limit lines are selectable. Their values are indicated at the left hand side of these lines.

All values higher than the upper limit, or lower than the lower limit, are represented as single off-scale dots.

The horizontal axis of the graph is the sequence of the samples (from left to right).

The resolution (max. number of positions) is:

Horizontally: 104

Vertically : 50 (+ 2 off-scale)

The horizontal scale can be set to X1 or X10.

In the X1 mode the memory depth is represented along the horizontal axis. As only 104 dots resolution is available, some dots (max. 10) may be positioned above each other. With samples having close analogue values one dot may represent more than one sample.

In the X10 mode, 1/10th part of the memory is displayed; the part of the memory can be selected with the data cursor (see below).

In the X10 mode each dot represents one sample.

The solid vertical line in the graph display is the data cursor. This is the same as the cursor in the data list display. Note that for correct reading of the contents of the data cursor the graph display must be in the X10 mode.

The dotted vertical line in the graph display is the position of the trigger word.

The main sections in the graph display are:

Error Message	Menu Name	Acquisition on/off
Condensed Menu		
GRAPH 1X L=#xx	Cursor on Line#=#Trig (Clock 0)	R=#yy
CURRENT TRIG'D	Data= 00111111	
000000FF	-----upper limit-----	

LABEL=A

00000000 -----lower limit-----

Graph heading

The following information is in the heading:

- Graph display with the horizontal expansion factor (X1 or X10).
- Data source (current or reference memory).

- Cursor position with respect to the data, and the cursor contents.

- The numbers of the first and the last sample on the graph display, as present in the data list. Also the trigger words can be indicated here.

Graph display

The upper- and lower limit lines control the vertical representation of the display. Sample values not fitting in between the limit lines are positioned just above the upper line or just below the lower line. The value of the limit lines can be set as indicated below, and are generally shown in the same base as the selected label.

Softkey functions

--HOR	--SCALE--		-----VERTICAL SCALE-----
X1	X10	LABEL	CHANGE LOWER UPPER SHIFT BEST

HOR SCALE X1 and X10

These keys set the horizontal expansion factor.

LABEL

After pressing this key the label to be displayed in the graph display, can be chosen.

VERTICAL SCALE

-CHANGE

Pressing this key presents the following softkey functions:

```

-----  -----  -----  -----  -----  MINIMUM MAXIMUM ENTER

```

The value of the indicated limit line can now be selected (the selected limit line is indicated with the symbol AV on the display). When pressing MINIMUM or MAXIMUM, the corresponding value is given to the limit line. The minimum or maximum value is the minimum or maximum value present in the label in the display.

The value can also be entered via the hex keyboard (after setting the value press the ENTER key).

Note that only 8 digits are available for the value of the limit lines. If more space is required, the base changes automatically to hexadecimal.

-LOWER

This key selects the lower limit line to be changed.

-UPPER

This key selects the upper limit line to be changed.

-SHIFT

This key selects both upper and lower limit lines to be changed. Now the AV symbol is with both lines. Both line values can be set with the cursor AV keys.

Both lines will be shifted for the same amount, up or down. This results in a window moving over the analogue values.

-BEST

After pressing the BEST key the upper limit line is set to the maximum value present in the samples on the display, and the lower limit line is set to the lowest value present in the samples on the display. This features a best possible resolution display.

Cursor functions

The data cursor in the graph display can be moved through the data with the <--> keys.

Note that in the graph X1 display the cursor can be moved through the data in the memory. In the graph X10 display however, the cursor stands still in the centre of the display while the data are moving along the display with respect to the cursor.

Independent of activation of the CHANGE key, the scroll cursor keys can be used.

With these keys the value of the limit lines indicated with the AV symbol will change.

5.3 TIMING DISPLAY

Press the TIMING key.

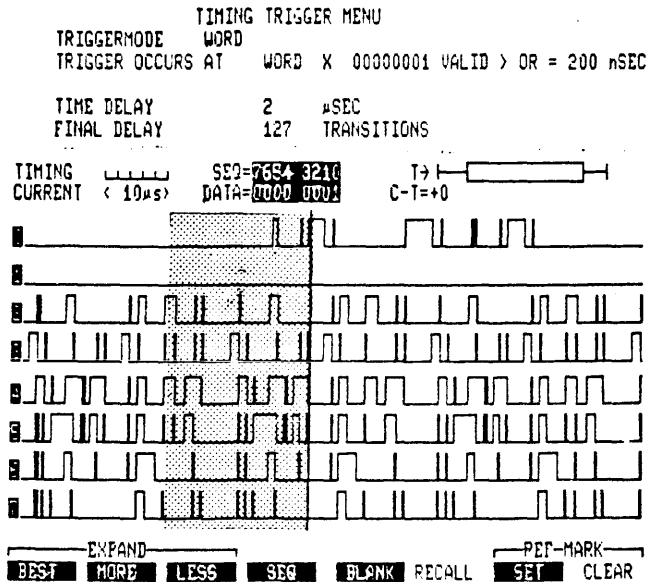

Fig. 5.5 Timing Display

Heading

The heading of the timing display contains the following information, from left to right:

TIMING : The name of the display
 CURRENT: The source of the data.

|_|_|_|_|_|_|_| Time scale, gives a quick impression of the value of
 < 10ms > the time axis.

SEQ=7654 3210 SEQ is the sequence of the channels as displayed on the
 DATA=0100 0010 screen, from bottom upwards.
 DATA is the corresponding contents of the data cursor.
 Blanked channels and their data cursor contents are
 shown in normal video.

T-> |--|-----|--| This is the Display-in-Memory symbol.
 The whole length between the vertical end lines
 of this symbol, represents the whole memory of
 the Logic Timing Analyzer.
 The rectangle on the line represents that section
 of the memory which is displayed on the screen.

The T with the arrow shows whether the trigger
 word is in the memory, or not.
 The arrow pointing to the right means that the
 trigger word is in the memory.
 The arrow pointing to the left means that the
 trigger word is not in the memory.

April 20, 1983

C-T= C-R= C-E=

C-T is the time between the cursor and the trigger sample.

C-R is the time between the cursor and the reference marker (this is only shown if the reference marker has been set).

C-E is the time between the cursor and the end of the memory in case of manual triggering (STOP).

Waveform-display

The display shows the waveforms of the input channels as captured in the memory. If no pulses are present on a channel, the logic level of that channel is indicated by the level of the line with respect to the channel number at the left hand side. The solid vertical line is the data cursor; its contents is given after DATA in the heading. This cursor is used as a viewing-aid, and can be moved with the SHIFT <--> keys. The dotted vertical line is the trigger sample.

Cursor- and trigger sample contents. Note that the contents of the data cursor, or of the trigger sample refers to the pulses which are located directly at the right-hand side of these lines. Refer to Fig. 5.6.

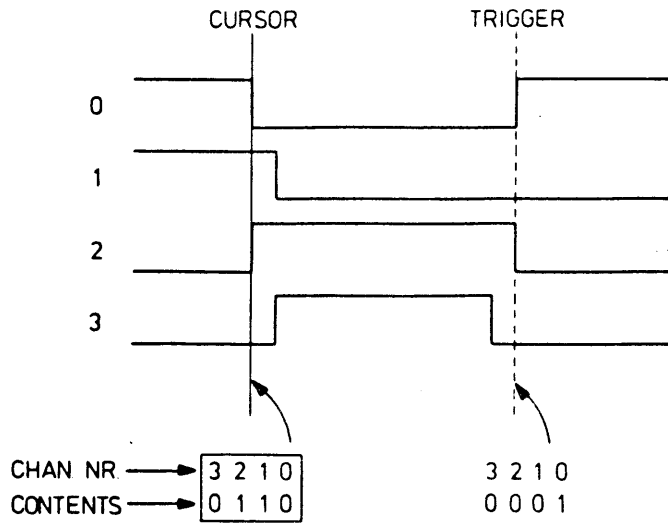

MA10612

CONTENTS OF DATA CURSOR AND TRIGGER WORD APPLY TO THE RIGHT-HAND SIDE OF THE LINES

Fig. 5.6 Cursor- and Trigger Contents.

Softkey functions

The following soft key labels are shown:

```
-----EXPAND-----          -REF- MARK-
BEST  MORE  LESS  SEQ  BLANK  RECALL  SET  CLEAR
```

The EXPAND functions control the time axis of the timing diagram:

-BEST shows the timing diagram just overlapping the display. If BEST has been chosen and you press LESS the waveform limit(s) will lay before the end of the display.

-MORE stretches the timing diagram, with expansion around the cursor position.

-LESS compresses the timing diagram (around the cursor position) Look at the Display-in-Memory symbol if you try these functions.

SEQ controls the sequence of the timing channels on the display. After pressing this key, the functions DEFAULT and ENTER appear. Pressing DEFAULT forces the default sequence of the timing channels on the display.

Instead of DEFAULT, the required sequence can be entered via the HEX pad keys 0--7.

The same channel can be positioned more than one time on the display.

The DELETE key can be used to correct false inputs.

After setting of the required sequence, press key ENTER. The original soft key functions reappear.

BLANK and RECALL functions work together, and control the number of the channels on the display. The blanked channels can be recalled with the RECALL key.

The REF- MARK function controls the reference marker with the SET and CLEAR softkeys.

This marker can be used for time measurement between two points on the timing diagram. If the marker is set, the C-R= formulae appears in the heading.

If key SET is depressed a reference marker appears on the screen. The default position of this marker is on the cursor.

When activating the SHIFT <--> keys the cursor is shifted over the diagram, trailing a half-tone veil. The C-R= formulae indicates the time between the veil limits. The veil limits need not be necessarily on the screen.

Cursor functions

SCROLL

If one or more channels on the display has been blanked, the Scroll function can be activated.

This function features smooth vertical displacement of the timing waveforms.

During scroll blanked channels appear on the screen, and others are disappearing, independent of the selected channel sequence.

SHIFT <-->

The SHIFT <--> keys feature horizontal movement of the data cursor. In the first instance the data cursor moves through the waveforms on the display. As soon as the end of the display has been reached, the data cursor sticks to his position, and the waveforms start moving thus showing another part of the memory. Look also at the Display-in-Memory symbol in the display heading.

5.3.1 TIMING COMPARE

For comparison of timing diagrams the following preparations are required:

- Store the reference data in the reference memory. This can be done by pressing the STORE DATA key by which data in the current memory is copied into the reference memory, or by storing external data via the I/O interface.
- Set the compare conditions in the timing compare menu.

After pressing the DATA COMPARE key, the result of the comparison is displayed.

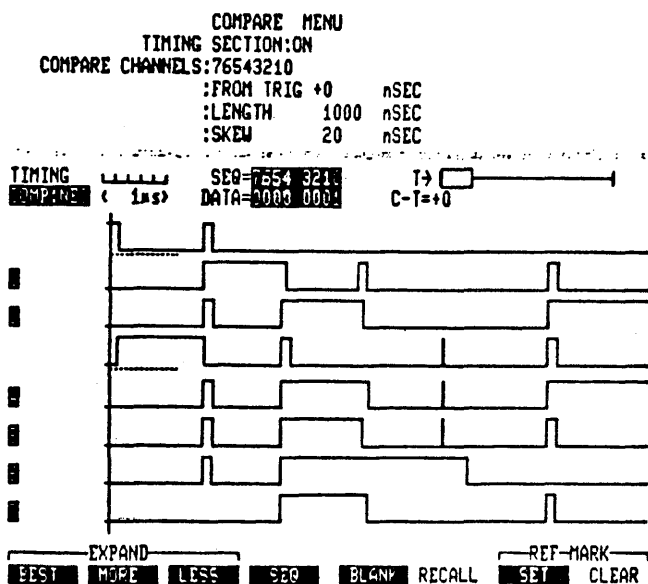

Fig. 5.7 Timing diagram compare mode

COMP is indicated in the list heading and the compare result EQ or NEQ is displayed. If COMP is displayed in reverse video the cursor is in the compare block as specified in the compare menu. Not-equal timing data will be indicated by dotted lines, and the relative channel numbers are blinking.

Timing compare is also possible in the auto mode, in three different ways:

- Stop if equal.
- Stop if not equal.
- Count failures and successes.

5.4 SYNC MODE

In the sync mode, the timing analyzer is triggered by the ENABLE LTA statement in the trigger sequence of the state analyzer.

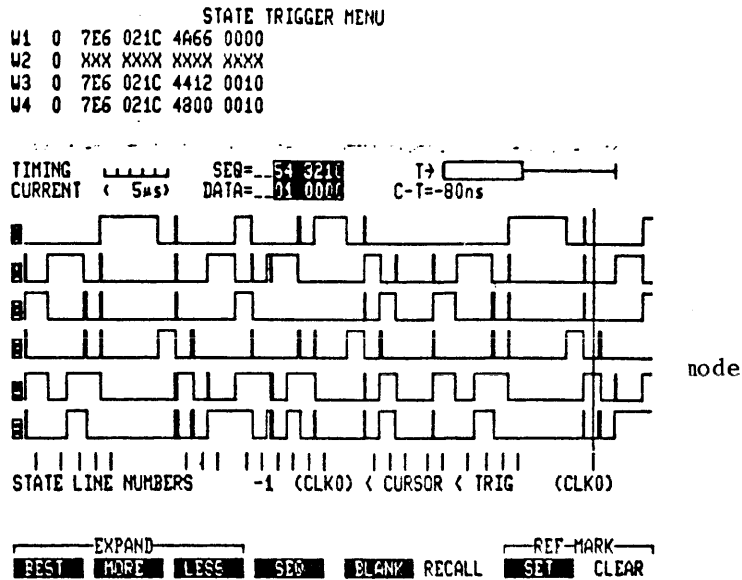

Fig. 5.8 Timing diagram sync mode

As explained in the description of the sync mode menu, there are now six timing channels max.

On the display under the timing diagram, a marker line, and state line numbers are present.

The markers represent the corresponding state samples. The state line number gives the position of the cursor with respect to the state samples.

The clock sources of the state samples is given between brackets. When going from timing- to state display, the cursor position is maintained, i.e. the top line of the state list corresponds to the cursor position, and the state line number in the timing display, when going from the state display to the timing display the timing cursor will be in its original position, it does not follow the state cursor.

NO SYNC POSSIBLE

This message appears under the sync timing display if the instrument cannot find the proper coupling between the state list and the timing diagram. This is when the word belonging to the ENABLE LTA statement in the trigger list is not present in the state analyzer memory.

C O N N E C T I O N

6. CONNECTION

```

XXXXXXXXXXXXXXXXXXXXXXXXXXXXXXXXXXXXXXXXXXXXXXXXXXXXXXXXXXXXXXXXXXXX
x  It is recommended to connect the Logic Analyzer, having the      x
x Configuration menu on the display, because there is strong relation- x
x ship between this display and the practical measuring set-up.      x
XXXXXXXXXXXXXXXXXXXXXXXXXXXXXXXXXXXXXXXXXXXXXXXXXXXXXXXXXXXXXXXXXXXX

```

6.1 CONNECTION OF THE INPUTS

All data, clock, and clock-qualifier input signals from the System under test are applied via (8-channel) Pods.
 The Pod identification as indicated on the rear panel of the Analyzer corresponds to the Pod labelling on the display.
 Note that the ground input of each Pod must be connected to a good circuit ground in the Sytem under test.
 The Pod plugs can be mechanically locked in the connectors at the rear panel of the Analyzer.

Applicable Pods:

State Analyzer : PM 8821
 Timing Analyzer: PM 8825

Before you proceed check all connections you made.

Data input

Data input uses Pods #0...#6 of the State Analyzer section, and Pod #0T of the Timing Analyzer.

Version I:

Normally Pod #0 input of the State Analyzer is not provided with an input connector, but is internally connected via a ribbon cable to the input circuit of the Timing Analyzer. In this case, the Pod #0 input of the State Analyzer at the rear of the instrument has been closed with a plate. So Pod #0 data of the State Analyzer are then the same as the Timing Analyzer input data. This set-up is also shown in the Configuration menu.

If desired, the set-up can be changed to obtain the Pod #0 input of the State Analyzer separated from the Timing Analyzer input.

This is realized by:

- Removing the internal flat cable between the Timing Analyzer (T 50-2) and The State Analyzer (S 15-2).
- Mounting the connector for Pod #0 on the State Analyzer.

Version II:

The Pod #0 input of the State Analyzer is always provided with a connenctor.

The internal connection of the input of Pod #0 of the State Analyzer section is controlled by a switch which is located on S15-2.

The switch can be manipulated through the rear panel by e.g. a ball point pen or a small screw driver.

In the 'in'-position Pod #0 of the State Analyzer is interconnected with Pod #0T of the Timing Analyzer. The Pod #0 input of the State Analyzer is not activated.

In the 'out'-position there is no interconnection between both Pods; Pod #0 and Pod #0T can be used separately.

Note that changing above Pod #0 input set-up does not influence the COMBI or SYNC mode.

Clock inputs

-State Analyzer

The clock signals must be applied via Pod #Q as in following table:

<u>Clock</u>	<u>Pod input nr.</u>
CLK0	7
CLK1	6
CLK2	5

-The Timing Analyzer has no external clock input.

Clock qualifier inputs

-State analyzer

The qualifier signals (max. 4) must be applied via Pod #Q, as in following table:

<u>Qualifier</u>	<u>Pod input nr.</u>
Q0	4
Q1	3
Q2	2
Q3	1

Independent of the number of clocks and/or qualifiers used, 3 channels of Pod #Q (input nrs. 0,1 and 2) are on the display.

Input 0 remains always available as a data channel.

Inputs 1 and 2 become available as data-channels when Q3 respectively Q2 are not in use (set as don't care).

-The Timing Analyzer has no external clock qualifier input.

6.2 WHAT ELSE TO CONNECT?

Except above inputs some more connections can be made.

Logic State Analyzer

-Input:

TRIG IN can be used as:

- trigger source or,
- trigger qualifier.

The signal must be applied to the TRIG IN coaxial connector at the rear of the state analyzer unit S15-1.

The signal must be a TTL signal which can be applied via a 50 ohm coax cable, or via the standard (5:1) probe PM 8800. Check the setting of the trigger qualifier in the corresponding menus.

-Outputs:

MATCH OUT delivers a TTL high signal at detection of the selected trigger word until the next trigger word (or final triggering) appears.

RUN OUT delivers a TTL high signal during data acquisition
i.e. between start and final triggering of the Logic State
Analyzer.

Logic Timing Analyzer

-Input:

TRIG IN can be used as an external trigger source (e.g. from the
system under test),
as well as trigger qualifier.

-Output:

MATCH OUT delivers an ECL high signal during presence of the trigger
word.

Video Interface Unit

Output:

COMP VIDEO delivers a video signal to drive an additional video
display, or a video printer.

U S E R M E S S A G E L I S T

April 27, 1983

7. USER MESSAGE LIST

User messages flash in the left top- and the right top corner of the display. The right top corner shows generally data acquisition status information.

After triggering, the message TRIG appears in the data-heading. After manual triggering (key Stop), the message MAN is shown.

The following messages are possible:

- ACQ. CLOCK OFF : A clock has been selected in the data menu, which is not activated in the configuration menu.
- BATTERY EMPTY : This is the battery of the resident setting-memory.
- BEGIN OF MEMORY: In the timing diagram; the cursor position has been set at the begin of the memory.
- CLOCK EMPTY : No samples taken by the specified clock source present in the memory, or a clock has been activated without any label.
- COMPARE BUSY : Internal compare program is running.
- COMP.LENGTH NEQ: Length of the compared blocks is not equal.
- CURSOR ADJUSTED: In the timing diagram; the analyzer has shifted the cursor to the valid data area.
- CURSOR ON TRIGW: The cursor must be on the trigger word, to copy a new word into the trigger word.
- CURSOR>TRIGWORD: Trigger word has been copied from the cursor contents.
- DISA CONF. SET : The Analyzer configuration is set by the selected disassembler.
- END OF MEMORY : In the timing diagram; the cursor position has been shifted to the end of the memory.
- ENTER 0--7 : In the timing diagram; enter a channel number.
- ENTER LABEL NR : Now a label must be entered to store a setting (Only with built-in non-volatile setting-memory option).
- ERASE AND STORE ON LABEL NO: If all labels in the non-volatile setting-memory are occupied, one label must be overwritten.
- ERROR IN VALUE : In configuration menu; threshold voltage not entered properly (e.g. 5..)
- FRACTION ERROR : The fraction does not correspond to the value mentioned in the specification or the unities.

- FROM NOT IN CUR: The 'from' limit is not in the current memory (state compare mode).
- FROM NOT IN REF: The 'from' limit is not present in the reference memory (state compare mode).
- ILL. START WORD: WRD1 or WRD2, combination in trigger menu may not be used in selective data acquisition menu.
WRD1>WRD2: WRD1 may not be used in selective data acquisition menu.
- ILL. STOP WORD : Refer to foregoing.
- KEY NOT ACTIVE : Not active softkey pressed.
- KEY NOT VALID : Wrong key pressed.
- LABEL EMPTY : An attempt was made to copy a trigger word from an empty label line in the data list.
Or:
An empty stored setting label is recalled. (Only with built-in non-volatile setting-memory option).
- LABEL IN ASCII : A label in ASCII-base is not permitted in the graph mode.
- LABEL PROTECTED: The label setting (or logic or base) cannot be changed. It is fixed by the activated disassembler.
- LIMITED SPACE : Screen overflow may occur if a label at the right-hand side of the label line in the configuration menu is converted to ASCII.
- LP NOT READY : If the printer is not ready for printing, this message flashes after approx. 20 sec.
- LSA NO CLOCK : No clock input since acquisition start.
- LSA:STEP X WRD : Indicates trigger status of the State Analyzer.
or DLY X is the trigger step number.
- LTA DELAY : The Timing analyzer is waiting in the final delay.
- LTA NO INPUT : No input signals on the Timing Analyzer.
- LTA NO TRIGW : -The Timing analyzer has not yet triggered.
-The Timing analyzer is not yet enabled by the State analyzer.
- LTA RUN : The Timing Analyzer has been started, but not yet triggered.
- NO ASCII INPUT : An ASCII word can not be entered.
- NO COMMON CHNLS: No common channels for comparison (timing compare).
- NO COMMON AREA : No common data area for comparison (timing compare).
- NO CURRENT DATA: Reference store not possible due to missing data.

- NO DATA PRESENT: No data present in the selected memory.
- NO END : In State trigger menu; no END statement at end of trigger sequence (true) list.
- NO FREE LABELS : All setting labels occupied.(Only with built-in non-volatile setting memory option).
- NO REF. DATA : No reference data available for comparison.
- NO ROLL DOWN : In the timing diagram; end of downwards soft scroll, or all eight channels on the display.
- NO ROLL UP : In the timing diagram; end of upwards soft scroll, or all eight channels on the display.
- NO STATE LABELS: In configuration menu; if no labels have been selected for the state analyzer.
- NO SYNC POSSIBLE: -This message appears under the SYNC MODE timing display, if the trigger word belonging to the ENABLE LTA statement in the trigger list is not present in the memory of the state analyzer, or
-If an IF statement is present in the trigger list and the state memory is full.
If NO SYNC POSSIBLE (1) or (2) is shown, check the two coax. cables which connect T50-2 and S15-2.
- NO TIME LABELS : In configuration menu; if no labels have been selected for the timing analyzer.
- NO TIMETRIG MENU: If the Timing analyzer has not selected, you cannot select the timing trigger menu.
- NOT A+DLY + BRK: Word A+delay may not be used in selective data acquisition, in the trigger on sequence break mode.
- NOT AVAILABLE : Option or function not installed.
- NOT BOTH TRIG'D: No normal triggering in current- and/or reference memory in the Timing analyzer.
- NOT FOUND : Memory word or sample as questioned is not present in the memory.
- NOT SELECTED : In the timing diagram; a channel is selected which has been switched-off in the configuration menu.
If an attempt to print is made and the printer has not yet been activated in the options menu.
- NOT WD B+ A+DLY: Use of word B and word A+delay is not allowed in selective data acquisition.
- NOT WRD B + BRK: Word B may not be used in selective data acquisition, in the trigger on sequence break mode.
- OVERRANGE : Attempts are made to enter too high a number or value.

- ONLY 20nS STEPS: In the timing diagram; time resolution is 20 nSec.
- P Q654321T OUT : The indicated Pod(s) has not been connected at the rear of the Logic Analyzer.
- PREPARING ACQUISITION START : The analyzer starts data acquisition.
- PRESS ENTER : Press the ENTER softkey to enter the new value or sequence.
- PRINT STOPPED : Print action has been aborted by pressing the Print key.
- PRINTKEY TO END: Printer activity can be halted by pressing the Print key again.
- REF.DATA STORED: Confirms that the reference memory just has been filled with data from the current memory.
- SCREEN OVERFLOW: A line (e.g. FORMAT) is too long. Change over to e.g. hexadecimal values.
- !SDA ACTIV! : If a Disassembler has been selected and you activate Selective Data Acquisition.
- SEARCHING : The instrument is searching for a specific sample.
- SELECT FULLMENU: With the printer activated and All Menus selected. Press the Full key.
- SELECT 'LIST' : With the printer activated and All Data selected, and if no list on the display. Press the List key.
- SELECT SECTION : The Data Display Compare function has been selected, without previous activation of the compare function.
- SEQ DEFAULT : In the timing diagram; the channel sequence has been changed to default, after changes of settings in the configuration menu.
- SETTING INVALID: -The instrument setting was not correct when you switched off the mains voltage earlier.
-In the Timing trigger menu incorrect value (e.g. 5..).
- SW RELEASE 51-XX: Identifier of the instrument's system software. Shown after switching-on.
- SPLIT LABEL : In configuration menu; in case of incorrect setting of the labels.
Equal label arrangement for different clocks is allowed.
'Scrambled' label arrangement is not allowed.
Refer to the examples in Fig. 7.1.
- STEP INCOMPLETE: In State trigger menu; step not complete.

- STOP ACQ. FIRST: If data acquisition is running (Single shot or Auto mode) some functions or parameters cannot be changed; so first press the STOP key.
- TO NOT IN CUR: The TO limit is not in the current memory (State compare).
- TO NOT IN REF: The TO limit is not in the reference memory (State compare).
- TRIG CLOCK OFF : A clock has been selected in the trigger menu, which is not activated in the configuration menu.
- UNDEFINED STEP : In State trigger menu; jump in trigger sequence list to an undefined step.
- USE BIN,OCT,HEX: In State trigger menu; trigger words can only be set in binary-, octal- or hexadecimal form.
- USE DECIMAL KEY: In configuration menu; when setting the threshold voltages do not use the hex keys.
- USE SOFTKEY : Press a softkey.
- WORD LABELLING : With many trigger words in the memory this may cost some time.
- WORD NOT IN CUR: That word is not in the current memory (State compare).
- WORD NOT IN REF: That word is not in the reference memory (State compare).
- WORDNO TOO HIGH: If words have been used in the selective data acquisition menu which are skipped in the trigger menu
- WRONG DISPLAY : With the printer activated and the Page print selected, not the proper display on the screen. Press List or Full Menu.

CLK0 --- ----- AAA--AAA

or,

CLK0 --- A----- --A----- -A-A-A-- -----A- -----A- -----A

Above is allowed.

CLK0 AAA BBBBBBBB CCCCCCCC DDDDDDDD EEEEEEEE FFFFFFFF GGGGGGGG GGGGGGGG
 CLK1 AAA BBBBBBBB CCCCCCCC DDDDDDDD EEEEEEEE FFFFFFFF GGGGGGGG GGGGGGGG

Above is allowed; same labels for more than one clock.
 Displays a data list without clock reference.

CLK0 AAA BBBBBBBBA CCCCCCCC DDDDDDDD EEEEEEEE FFFFFFFF GGGGGGGG GGGGGGGG

or,

CKL0 AAA AAAAAAAAA BBBBBBBB CCCCCCCC EEEEEEEE FFFFFFFF GGGGGGGG GGGGGGGG
 CKL1 AAA AAA---AA BBBBBBBB CCCCCCCC EEEEEEEE FFFFFFFF GGGGGGGG GGGGGGGG

Above is not allowed; label A cannot be grouped.
 Gives SPLIT LABEL operation lock.

Fig. 7.1. Some split-label examples

8

O P E R A T I O N

8. OPERATION

8.1 GENERAL

In this chapter we discuss operation hints, clarified with some examples.

The following subjects will be discussed.

- Triggering
- Selective data acquisition
- Compare mode
- Combi mode
- Synced mode

8.2 TRIGGERING

General information

Why Triggering?

Triggering gives you all means to obtain that section of a program you just wanted in the analyzer's memory.

Your tools are:

- Up to 8 selectable triggerwords
- Various delays or counters (on samples, occurrences, or time)
- Sophisticated IF/THEN ELSE trigger menu composition language

There are two main possibilities of triggering:

1. Trigger on sequence true
2. Trigger on sequence break

In the following some details on the trigger sequence set up will be discussed.

TRIGGER SEQUENCE DETAILS

The trigger menu is built-up of a number of sequential steps.

The next step is initiated when you press softkey NEXT.

The last step is always an END.

FIND WORD 1

This means that triggerword 1 must be present in the input stream before the analyzer proceeds to the next step in the sequence.

FIND WORD 1 > 2

As above, but the next sample following word 1 must be word 2, (no matter which clock).

FIND WORD 1 OR 2

As above, but word 1 or word 2 must be present.

The OR-structure can be extended by a conditional jump to another step in the list.

E.g.:

```
FIND WORD 1 OR 2
```

```
IF WORD 1 THEN STEP 4 ELSE STEP 5
```

means that if word 1 is found, action is transferred to step 4, and if word 2 is found the next step will be 5.

The ELSE STEP statement may be omitted.

```
IF WORD 1, or 1 > 2, or 1 OR 2
```

This structure is always followed by one of the delay statements:

```
IN DELAY or,
```

```
AT DELAY
```

After a FIND WORD statement a DELAY can be added.

This can be by:

- States : the delay counter counts the specified number of the required state clocks.
- Occurrences: the delay counter counts a specified number of occurrences of a specified word.
- Time : a specified time delay is used.

The use of an IF WORD statement after a delay has been set enables conditional branches of the trigger sequence on the following conditions.

In delay: The word is to be found before the delay is finished.

At delay: The word is to be found on the sample which immediately follows the end of the delay count.

Specifying either IN or AT DELAY results in the generation of THEN STEP...ELSE STEP.

So enabling the entry of the step to which trigger control should be transferred.

Delay on samples means that every sample no matter which clock, counts down the delay by one.

Delay on occurrences means that every selective.

Delay on time speaks for itself.

```
FIND WORD 1 DELAY 1000 SAMPLES
```

```
FIND WORD 2
```

This means that after finding word 1 in the input stream, a delay of 1000 samples must pass, before the analyzer looks for word 2.

HINT: CLOCK IDENTIFIER

One data bit channel can be used as identifier for the clock.
 Apply the clock signal to a free data bit.
 With a positive-going clock a '0' bit is shown; with a negative-going clock a '1' bit is shown.
 This obtained by the zero-hold time of the clocks.

8.3 SELECTIVE DATA ACQUISITION

FROM WORD X (+delay value) TO WORD Y (+delay value)
 Words X and Y are words which have been registered in the trigger sequence list.
 Also the facultative delay values are in the trigger sequence list mentioned adjacent to the triggerwords.

If a certain block is present many times in the input stream, the blocks are 'glued' together in the analyzer memory.

For words X and Y can be used triggerwords 1---7 as registered in the trigger sequence list.

8.4 COMPARE MODE

GENERAL

In the compare mode, data in the acquisition memory is compared with data in the reference memory.
 Both the state analyzer as well as the timing analyzer have a compare mode, and have their own reference memory.
 After comparison unequal data are accented in the data displays.
 The reference memories can be filled with data by:
 -Copying data from the acquisition memory, or
 -Externally supplied data (via the I/O interface).
 Comparison of data can be done in the single shot mode, and in the auto mode.
 In the auto mode a counter is available to count equal, or unequal comparisons.

STATE SECTION

TIMING ANALYZER

Transitional clocking

Two requirements for an analyzer are contradictory:
 -High sampling rate
 -Large memory depth

In transitional clocking in fact two memories are used.
 One memory stores only the different input bit patterns. As long as an input bit pattern does not change no new address in this memory will be selected.

In parallel to this bit pattern memory, is a memory which saves the time duration of each different input bit pattern.
 The input bit patterns are always sampled with the 20 nS clock and also the time duration memory resolution is 20 nS.
 The time duration memory is 20 bits wide. If a sample takes longer than the capacity of these 20 bits, the next address of the memory is selected and a new 20 bits time duration is available.
 Due to this principle a high sample resolution and a virtual deep sample memory is obtained.

I N T E R F A C E A N D O P T I O N S

9. INTERFACE AND OPTIONS

INTRODUCTION

This chapter gives information on the available options and how they must be built-in.

After pressing the OPTION key, the display shows all selectable I/O and disassembler functions.

The I/O functions depend on the built-in option board. See following tabel.

Option board: Function:

PM 8851/00 Printer output only (1 interface).

PM 8851/20 Printer output and RS232C control (2 interfaces).

PM 8851/40 Printer output and IEEE control (2 interfaces).

For installation instructions for an Option board refer to chapter 10.

9.1 PRINTER INTERFACE

The printer interface is the standard RS232C interface in all 3 cases.

Any RS 232 printer can be used; some possibilities are:

-Philips PC 1423/00

-Lear and Siegler Ballistic 310

-Epson MX80

For use of the printer with the PM 3551, refer to chapter 4.1.5.

The printer must be connected according to the following diagram.

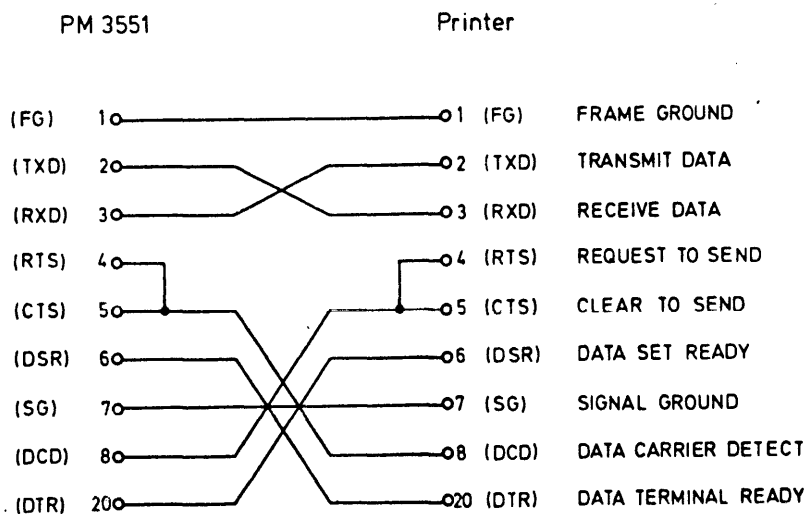

MA10742

Fig. 9.1 RS232C printer connection cable

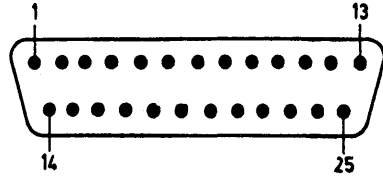

Fig. 9.2 RS232C connector CONNECTORS AS SEEN
ON THE INSTRUMENTS

Print characters

Some special characters on the PM 3551 display are replaced by printable characters as indicated in following table:

DISPLAY CHARACTER -->PRINTED CHARACTER

Character	Code	Character	Code
⏏	21	!	7C
⏏	2D	-	68
⏏	2D	-	69
⏏	2D	-	6A
⏏	2D	-	7F
⏏	30	0	77
⏏	31	1	76
⏏	3C	<	63
⏏	3E	>	62
⏏	75	u	75

Recommended printer switch settings:

-Epson MX80

1-on	2-on	3-off	4-off
5-on	6-on	7-off	8-off

OPTION BOARD SUB-FUNCTIONS

An option board can be provided with the following sub-functions:

-Disassembler packages:

Disa A: Most common micro processors	=PM 8850/00
Disa M: Motorola micro processors	=PM 8850/20
Disa N: Intel micro processors	=PM 8850/10
Disa Z: Zilog micro processors	=PM 8850/30
Disa R: Other micro processors and IEEE488/IEC625 disa	=PM 8850/40

-Non-volatile memory (for instrument settings) =PM 8850/80

This is a memory package to store 4 user-defined instrument settings.

For installation instructions for the sub-functions refer to chapter 10.

For operation refer to chapter 4.

9.2 DISASSEMBLERS GENERAL

When selecting a disassembler package via the menu, the display shows the name of this package and the release number, e.g. 'M PACKAGE REL.01'. When a certain disassembler has been selected via the menu, the configuration is automatically set according to the specific micro processor disassembler requirements.

It is possible (though not recommended) to change this configuration (e.g. clocks or qualifiers). Refer to chapter 4.

The disa settings are given in following text with the various micro processors.

If a disassembler programm does not know whether a certain byte is an opcode or not, '***' is displayed instead of the mnemonics.

If a disassembler programm reads an opcode for a certain byte and that opcode does not exist for that micro processor, 'ILLEGAL' is displayed.

All obtained mnemonics are as they are published in the manufacturer's handbooks.

In the following we discuss the connection and the display of the various Disassemblers.

9.2.1 DISASSEMBLER-ACCESORIES PM 8815, PM 8816 and PM 8817.

In order to accomodate connection of the Logic Analyzer input to the micro processor under test the PM 8817 can be used. Refer to Fig. 9.3.

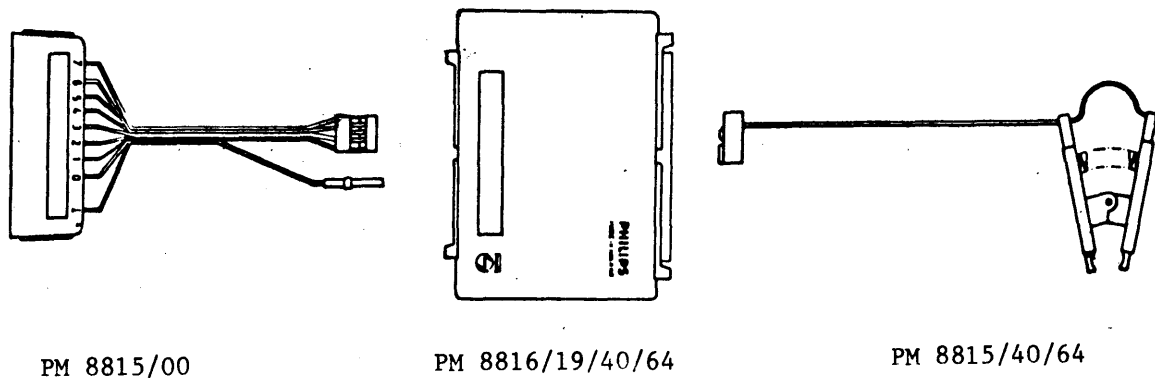

Fig. 9.3 PM 8817 Micro processor personality adaptor

This adaptor contains a wiring facility to apply the correct wiring.

- PM8817/19 Personality adaptor for the 68000
- PM8817/40 Personality adaptor for 40-pin micro processors
- PM8817/64 Personality adaptor for 64-pin micro processors

Note that the personality box of the PM 8817/19 has been pre-wired (printed circuit) for disassembly of the 68000. More signals can be wired by the user.

The personality boxes of the PM 8817/40 and /64 are supplied without internal wiring.

This wiring can be made by the user himself according to the specified micro processor. Refer to the enclosed specific micro processor connection lists and drawings.

For above complete adaptor assemblies the following replacement parts are available:

- PM8815/00 Pod nozzle for personality adaptor.
You need five Pod nozzles for 35-channel analyzers, and eight of them for 59-channel analyzers. Each nozzle can be mated to the PM 8821 or PM 8825 Pod at one side, and via the smaller plugs to the PM 8816 personality box.
- PM8815/40 40-pin micro processor clip with ribbon cable, connecting to the PM 8816 personality box.
- PM8815/64 Same as PM8815/40 but 64-pin.
- PM8816/19 Personality box for the 68000.
- PM8816/40 Personality box for 40-pin micro processors.
- PM8816/64 Personality box for 64-pin micro processors.

XX
 X Note: X
 X A disassembler requires a specific connection of the input X
 X channels, otherwise correct disassembly is not possible. X
 XXX

The proper wiring for the disassembler is made in the personality box. To this end open this box, and y'll find numbered plug (knife) contacts. It is recommended to use the wire and the insertion tool as supplied with the option, to make the connections as indicated in the following chapters. The insulation of the wire need not to be stripped; these contacts cut through the insulation. Don't apply more than two wires in one contact.

Wire specification: Standard UN-R1072
 Solid silver plated annealed copper wire, with PTFE insulation.
 AWG 30
 Nominal conductor dia. 0,25mm.
 Nominal conductor cross section 0,05 mm²
 Overall dia. 0,55 mm approx.

Insertion tool for plug contacts:
 Manufacturer: Scotchflex 3M
 Type : 3522

In the following lists the connections are given, which must be made in the personality box to adapt the circuit to the specific micro processor. In this lists the various Pod inputs are given as well as the numbering of the clip contacts. These indications can also be found in the personality box itself.

When a Pod is not in use for the disassembler, this Pod can be used for additional data display. Also not used channels of Pod #Q (indicated as 'free') can be used for this purpose.

9.2.2 NON-VOLATILE MEMORY

If the instrument has been provided with this memory, the softkey STORED in the configuration menu is activated.

For operation refer to chapter 4.

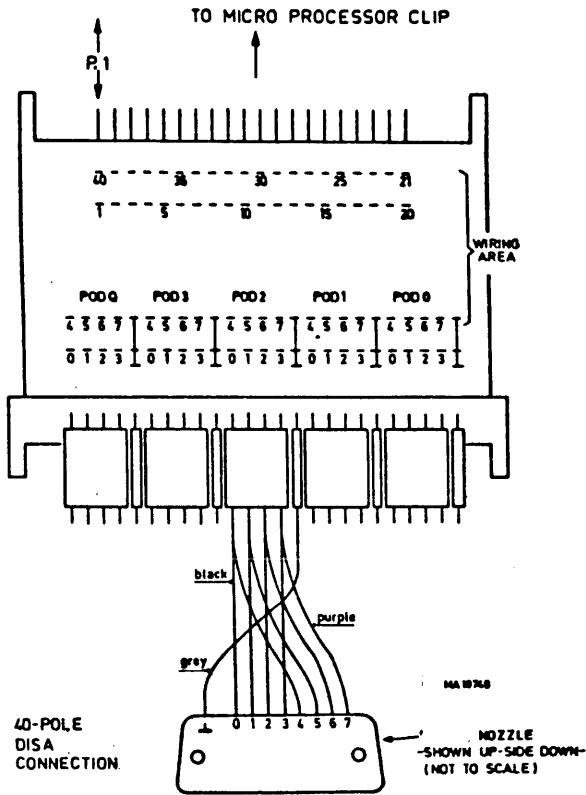

Fig. 9.4 40-pin personality adaptation via PM 8817/40

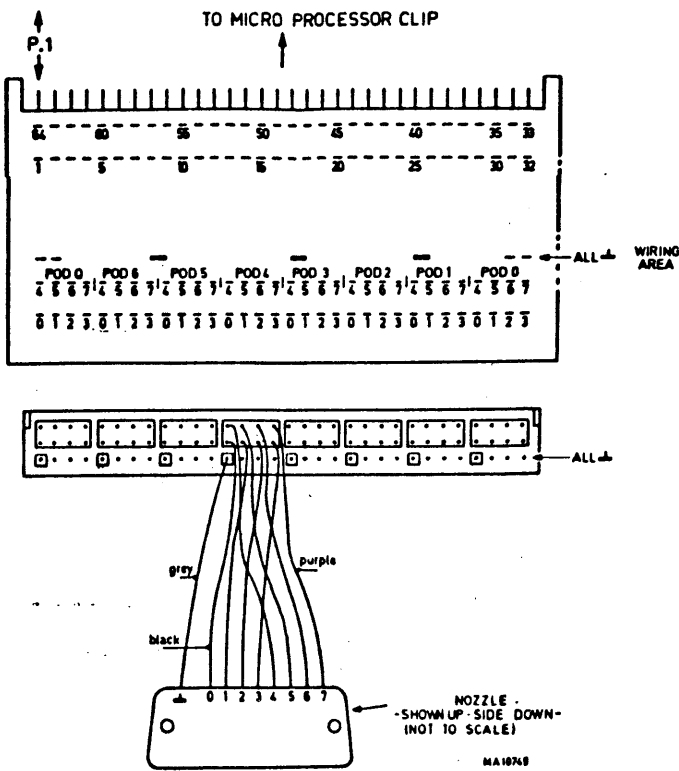

Fig. 9.5 64-pin personality adaptation via PM 8817/64

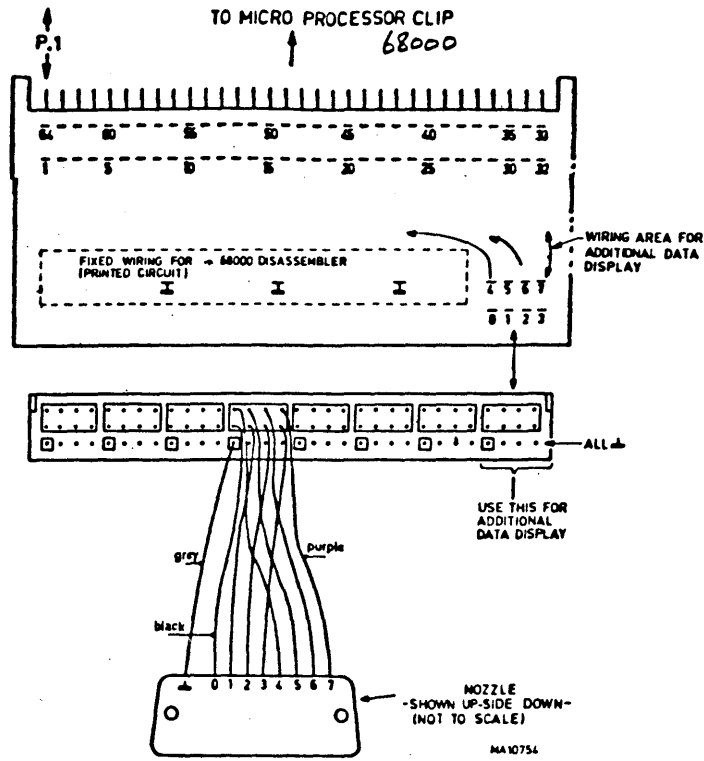

Fig. 9.6 68000 personality adaptation via PM 8817/19

9.3

DISASSEMBLER CONNECTIONS AND DISPLAY

AAAA
AAAAAA
AAA AAA
AAA AAA
AAAAAAAAAAAA
AAAAAAAAAAAA
AAA AAA
AAA AAA

9.3.1

DISASSEMBLER PACKAGE A

This package features disassembly programmes for the following micro processors:

-Z80	Page 9.
-8085	Page 9.
-68000	Page 9.

Software release: A PACK 51-1.0

*** Z80 ***

CONNECTION

<u>POD#Q--CLIP</u>		<u>POD#3--CLIP</u>	
CLK0	7--19 (MREQN)	7--5	(A15)
CLK1	6--20 (IOREQN)	6--4	(A14)
CLK2	5--N.C.	5--3	(A13)
Q0	4--28 (RFSHN)	4--2	(A12)
Q1	3--N.C.	3--1	(A11)
	2--27 (M1N)	2--40	(A10)
	1--21 (RDN)	1--39	(A9)
	0--N.C.(free)	0--38	(A8)
	GND--29	GND--29	

<u>POD#2--CLIP</u>		<u>POD#1--CLIP</u>	
	7--37 (A7)	7--13	(D7)
	6--36 (A6)	6--10	(D6)
	5--35 (A5)	5--9	(D5)
	4--34 (A4)	4--7	(D4)
	3--33 (A3)	3--8	(D3)
	2--32 (A2)	2--12	(D2)
	1--31 (A1)	1--15	(D1)
	0--30 (A0)	0--14	(D0)
	GND--29	GND--29	

Pod #0 is free for other signal inputs.

SETTINGS

Following settings are selected automatically.

CLOCKS	CLOCKS	QUALIFIERS	Q0	Q1	Q2	Q3
	CLK0=	TRUE	1	X	X	X
	CLK1=	TRUE	1	X	X	X
	CLK2=OFF					

	POD-Q	POD#3	POD#2	POD#1	POD#0
LABEL	CLK0=AA-	BBBBBBBB	BBBBBBBB	CCCCCCCC	-----
	CLK1=AA-	BBBBBBBB	BBBBBBBB	CCCCCCCC	-----

DISPLAY

The following columns are displayed:

<LINE #> <ST> <ADDR> <DT> <MNEMONIC> <INT>

In which:

The opcodes are sampled with clock 0, thus the mnemonics are displayed behind clock 0.

The addresses are shown before the opcodes and other data sampled with clock 0.

Clock 1 samples I/O cycles (and interrupts).

Refresh cycles are not sampled (Q0=1).

The 'non maskable' interrupt is shown as 'NMI'; the other interrupts cannot be distinguished and are shown as 'INT'.

*** 8085 ***

CONNECTION

<u>POD#Q--CLIP</u>		<u>POD#3--CLIP</u>	
CLK0	7--30 (ALF)	7--28	(A15)
CLK1	6--32 (RDN)	6--27	(A14)
CLK2	5--31 (WRN)	5--26	(A13)
Q0	4--38 (HLDA)	4--25	(A12)
	3--N.C.	3--24	(A11)
	2--29 (S0)	2--23	(A10)
	1--33 (S1)	1--22	(A9)
	0--34 (IO/MN)	0--21	(A8)
	GND--20	GND--20	

POD#2--CLIP

7--19 (AD7)
6--18 (AD6)
5--17 (AD5)
4--16 (AD4)
3--15 (AD3)
2--14 (AD2)
1--13 (AD1)
0--12 (AD0)
GND--20

POD#1 and POD#0 are free for other signal inputs.

SETTINGS

Following setting is selected automatically.

CLOCKS	CLOCKS	QUALIFIERS	Q0	Q1	Q2	Q3
	CLK0=	TRUE	0	X	X	X
	CLK1=	TRUE	0	X	X	X
	CLK2=	TRUE	0	X	X	X

	POD#Q	POD#3	POD#2	POD#1	POD#0
LABEL	CLK0=AAA	BBBBBBBB	BBBBBBBB	-----	-----
	CLK1=----	-----	CCCCCCCC	-----	-----
	CLK2=----	-----	CCCCCCCC	-----	-----

DISPLAY

The following columns are displayed:
<LINE #> <STA> <ADDR> <DT> <MNEMONIC> <INT>

In which:

<STA> = Status

<ADDR>= Address

<DT> = Data

Opcodes are sampled with clock CLK1, thus the mnemonics are displayed behind CLK1.

Each line starts with processor status information.

Clock0 samples the complete address and the status information.

The following interrupts can be recognized: TRAP, INTR, RST5.5, RST6.5, and RST7.5. If an interrupt cannot be recognized, UNINT (Unidentified Interrupt) is displayed. DMA activity is not sampled (Q0=0).

*** 8085 *** (cont'd)

Because both RDN and WRN are used as clocks, also all read and write activity is sampled, together with the complete address.

Except the standard mnemonics as published in the data handbooks, also the following instruction (accompanied with a '+' can be disassembled:

08_H=DSUB (Double Subtraction)
 (H)(L)=(H)(L)-(B)(C)

10_H=ARHL (Arithmetic right shift of H and L)
 (H7)=(H7) (Hn-1)=(Hn) (L7)=(H0) (Ln-1)=(Ln) (CY)=(L0)

18_H=RDEL (Rotate D and E left through carry)
 (Dn+1)=(Dn) (D0)=(E7) (CY)=(D7) (En+1)=(En) (E0)=(CY)

28_H=LDHI (Load D and E with H and L plus immediate byte)
 (D)(E)=(H)(L)+byte

38_H=LDSI (Load D and E with SP plus immediate byte)
 (D)(E)=(SPH)(SPL)+byte

CB_H=RSTV (Restart on overflow)
 ((SP)-1)=(PCH) ((SP)-2)=(PCL) (SP)=(SP)-2 (PC)=40_H

D9_H=SHLX (Store H and L indirect through D and E)
 ((D)(E))=(L) ((D)(E)+1)=(H)

DD_H=JNX5 (Jump if X5 flag is reset)
 If (not X5): (PC)=(byte3)(byte2)

ED_H=LHLX (Load H and L indirect through D and E)
 (L)=((D)(E)) (H)=((D)(E)+1)

FD_H= JX5 (Jump if X5 flag is set)
 If (X5): (PC)=(byte3)(byte2)

*** 68000 ***

CONNECTIONPOD#Q--CLIP

CLK0 7--7 (UDS)
 CLK1 6--8 (LDS)
 CLK2 5--N.C.
 Q0 4--N.C.
 Q1 3--N.C.
 2--23 (IPL2)
 1--24 (IPL1)
 0--25 (IPL0)
 GND--16 or 53

POD#6--CLIP

7--22 (BERR)
 6--17 (HALT)
 5--9 (R/W)
 4--7 (UDS)
 3--8 (LDS)
 2--26 (FC2)
 1--27 (FC1)
 0--28 (FC0)
 GND--16 or 53

POD#5--CLIP

7--52 (A23)
 6--51 (A22)
 5--50 (A21)
 4--48 (A20)
 3--47 (A19)
 2--46 (A18)
 1--45 (A17)
 0--44 (A16)
 GND--16 or 53

POD#4--CLIP

7--43 (A15)
 6--42 (A14)
 5--41 (A13)
 4--40 (A12)
 3--39 (A11)
 2--38 (A10)
 1--37 (A9)
 0--36 (A8)
 GND--16 or 53

POD#3--CLIP

7--35 (A7)
 6--34 (A6)
 5--33 (A5)
 4--32 (A4)
 3--31 (A3)
 2--30 (A2)
 1--29 (A1)
 0--N.C.
 GND--16 or 53

POD#2--CLIP

7--54 (D15)
 6--55 (D14)
 5--56 (D13)
 4--57 (D12)
 3--58 (D11)
 2--59 (D10)
 1--60 (D9)
 0--61 (D8)
 GND--16 or 53

POD#1---CLIP

7--62 (D7)
 6--63 (D6)
 5--64 (D5)
 4--1 (D4)
 3--2 (D3)
 2--3 (D2)
 1--4 (D1)
 0--5 (D0)
 GND--16 or 53

POD#0 is free for other
 signal inputs.

Note: All above connections are pre-wired in the PM 8817/19.

*** 68000 *** (cont'd)

SETTINGS

Following settings are selected automatically.

CLOCKS	CLOCKS	QUALIFIERS	Q0	Q1	Q2	Q3
	CLK0=	TRUE	X	X	X	X
	CLK1=	TRUE	X	X	X	X
	CLK2=OFF					

POD#Q	POD#6	POD#5	POD#4	POD#3	POD#2	POD#1	POD#0
CLK0 AAA	BBCCDDDD	EEEEEEEE	EEEEEEEE	EEEEEEEE	FFFFFFFF	FFFFFFFF	-----
CLK1 AAA	BBCCDDDD	EEEEEEEE	EEEEEEEE	EEEEEEEE	FFFFFFFF	FFFFFFFF	-----

DISPLAY

The following columns are displayed:

<LINE #> <I> <H> <M> <S> <ADDRES> <DATA> <FC> <MNEMONIC> <OPERAND>

In which:

<I> = Interrupt signals
 <H> = Halt signals
 <M> = Mode of operation
 <S> = Status signals

Opcodes are sampled by clock0 thus the mnemonics are displayed behind this clock.

Interrupts will be recognized; behind the interrupt opcode is shown which IPL lines have been activated.

DMA activity is not sampled.

FREE POD

POD#0 is not used for disassembly purposes.

This Pod can be used to display additional data if required.

The desired connections can be made in the interface block, refer to Fig. 9.6.

DETAILED DISPLAY INFORMATION

<LINE #> Decimal line number (-1023..1023)

<I>	Interrupt signals <IPL2, IPL1, IPL0>	Interrupt level
-----		-----
	0	7
	1	6
	2	5
	3	4
	4	3
	5	2
	6	1
	7	0 (= no interrupt)

*** 68000 *** (cont'd)

<H> Halt signals

<BERR, HALT>	Description
0	BERR and HALT active
1	HALT active
2	BERR active
3	No halt instruction

<M>

Mode of operation <R/W, UDS, LDS>	Description
0	WRITE (word)
1	WRITE (upper-byte)
2	WRITE (lower-byte)
3	
4	READ (word)
5	READ (upper-byte)
6	READ (lower-byte)

<S>

Status signals <FC2, FC1, FC0>	Description
0	(unassigned)
1	User data
2	User programm
3	(unassigned)
4	(unassigned)
5	Supervisor data
6	Supervisor programm
7	Interrupt acknowledge

<ADDRESS> Hexadecimal address <A23..A0> -> 16 Mega-bytes

<DATA> Hexadecimal data <D15..D0>

<FC>

Function codes <FC2, FC1, FC0>	Description
UF	(unassigned)
UD	User data
UP	User Programm
UF	(unassigned)
UF	(unassigned)
SD	Supervisor data
SP	Supervisor programm
IA	Interrupt acknowledge

<MNEMONIC> Opcode compilation

<OPERAND> 0, 1 or 2 <operand-part> separated by a comma.

MMM MMM
MMMM MMMM
MMMMMM MMMMM
MMM MMMMM MMM
MMM MMM MMM
MMM MMM
MMM MMM
MMM MMM

9.3.2

DISASSEMBLER PACKAGE M

This package features disassembly programs for the following micro processors:

-6800/02/08	Page 9.
-6809/E	Page 9.
-68000	Page 9.

Software release: M PACK 51-1.0

*** 6800/02/08 ***

CONNECTION

<u>POD#Q--CLIP</u>		<u>POD#3--CLIP</u>	
CLK0	7--37 (∅)		7--25 (A15)
CLK1	6--N.C.		6--24 (A14)
CLK2	5--N.C.		5--23 (A13)
Q0	4--5 (VMA)		4--22 (A12)
Q1	3--7 (BA)		3--20 (A11)
	2--34 (R/WN)		2--19 (A10)
	1--N.C.(free)		1--18 (A9)
	0--N.C.(free)		0--17 (A8)
	GND--*)		GND--*)

<u>POD#2--CLIP</u>		<u>POD#1--CLIP</u>	
	7--16 (A7)		7--26 (D7)
	6--15 (A6)		6--27 (D6)
	5--14 (A5)		5--28 (D5)
	4--13 (A4)		4--29 (D4)
	3--12 (A3)		3--30 (D3)
	2--11 (A2)		2--31 (D2)
	1--10 (A1)		1--32 (D1)
	0--9 (A0)		0--33 (D0)
	GND--*)		GND--*)

*) GND pin of the specific micro processor.

POD#0 is free for other signal inputs.

SETTINGS

Following settings are selected automatically.

CLOCKS	CLOCKS	QUALIFIERS	Q0	Q1	Q2	Q3
	CLK0=	TRUE	1	0	X	X
	CLK1=	OFF				
	CLK2=	OFF				

	POD#Q	POD#3	POD#2	POD#1	POD#0	
LABEL	CLK0=	A--	BBBBBBBB	BBBBBBBB	CCCCCCCC	-----

DISPLAY

The following columns are displayed:
 <LINE #> <ST> <ADDR> <DT> <MNEMONIC> <INT>
 The opcodes, data, processor status, and addresses are sampled with clock 0.

INTERRUPTS AND DMA

The interrupts RESET, IRQ and NMI can be displayed. If insufficient data is available UNINT may be displayed.

DMA activity is not sampled (Q1=0).

*** 6809/E ***

CONNECTION

<u>POD#Q--CLIP</u>		<u>POD#3--CLIP</u>	
CLK0	7--34 (E)	7--23	(A15)
CLK1	6--N.C.	6--22	(A14)
CLK2	5--N.C.	5--21	(A13)
Q0	4--6 (BA)	4--20	(A12)
	3--N.C.	3--19	(A11)
	2--5 (BS)	2--18	(A10)
	1--32 (R/WN)	1--17	(A9)
	0--N.C. (free)	0--16	(A8)
GND--1	(Vss)	GND--1	(Vss)

<u>POD#2--CLIP</u>		<u>POD#1--CLIP</u>	
7--15	(A7)	7--24	(D7)
6--14	(A6)	6--25	(D6)
5--13	(A5)	5--26	(D5)
4--12	(A4)	4--27	(D4)
3--11	(A3)	3--28	(D3)
2--10	(A2)	2--29	(D2)
1--9	(A1)	1--30	(D1)
0--8	(A0)	0--31	(D0)
GND--1	(Vss)	GND--1	(Vss)

SETTINGS

Following settings are selected automatically.

CLOCKS	CLOCKS	QUALIFIERS	Q0	Q1	Q2	Q3
	CLK0=	TRUE	0	X	X	X
	CLK1=	OFF				
	CLK2=	OFF				

	POD#Q	POD#3	POD#2	POD#1	POD#0
LABEL	CLK0= AA-	BBBBBBBB	BBBBBBBB	CCCCCCC	-----

DISPLAY

The following columns are displayed:
 <LINE #> <ST> <ADDR> <DT> <MNEMONIC> <INT>
 The opcodes, data, processor status, and addresses are sampled with clock 0.

INTERRUPTS AND DMA

The interrupts RESET, IRQ, FIRQ and NMI can be displayed. If insufficient information is available, UNINT may be displayed.
 DMA activity is not sampled (Q1=0).

SYNCHRONIZATION

When a lot of '***' messages is displayed under mnemonics with the 6809/E, this means that the disassembler program does not find correct synchronization.
 In this case select manual synchronization as described in chapter 4.

*** 68000 ***

CONNECTIONPOD#Q--CLIP

CLK0 7--7 (UDS)
 CLK1 6--8 (LDS)
 CLK2 5--N.C.
 Q0 4--N.C.
 Q1 3--N.C.
 2--23 (IPL2)
 1--24 (IPL1)
 0--25 (IPL0)
 GND--16 or 53

POD#6--CLIP

7--22 (BERR)
 6--17 (HALT)
 5--9 (R/W)
 4--7 (UDS)
 3--8 (LDS)
 2--26 (FC2)
 1--27 (FC1)
 0--28 (FC0)
 GND--16 or 53

POD#5--CLIP

7--52 (A23)
 6--51 (A22)
 5--50 (A21)
 4--48 (A20)
 3--47 (A19)
 2--46 (A18)
 1--45 (A17)
 0--44 (A16)
 GND--16 or 53

POD#4--CLIP

7--43 (A15)
 6--42 (A14)
 5--41 (A13)
 4--40 (A12)
 3--39 (A11)
 2--38 (A10)
 1--37 (A9)
 0--36 (A8)
 GND--16 or 53

POD#3--CLIP

7--35 (A7)
 6--34 (A6)
 5--33 (A5)
 4--32 (A4)
 3--31 (A3)
 2--30 (A2)
 1--29 (A1)
 0--N.C.
 GND--16 or 53

POD#2--CLIP

7--54 (D15)
 6--55 (D14)
 5--56 (D13)
 4--57 (D12)
 3--58 (D11)
 2--59 (D10)
 1--60 (D9)
 0--61 (D8)
 GND--16 or 53

POD#1--CLIP

7--62 (D7)
 6--63 (D6)
 5--64 (D5)
 4--1 (D4)
 3--2 (D3)
 2--3 (D2)
 1--4 (D1)
 0--5 (D0)
 GND--16 or 53

POD#0 is free for other
 signal inputs.

Note: All above connections are pre-wired in the PM 8817/19.

*** 68000 *** (cont'd)

SETTINGS

Following settings are selected automatically.

CLOCKS	CLOCKS	QUALIFIERS	Q0	Q1	Q2	Q3
	CLK0=	TRUE	X	X	X	X
	CLK1=	TRUE	X	X	X	X
	CLK2=OFF					

POD#Q	POD#6	POD#5	POD#4	POD#3	POD#2	POD#1	POD#0
CLK0 AAA	BBCCCDDD	EEEEEEEE	EEEEEEEE	EEEEEEEE	FFFFFFFF	FFFFFFFF	-----
CLK1 AAA	BBCCCDDD	EEEEEEEE	EEEEEEEE	EEEEEEEE	FFFFFFFF	FFFFFFFF	-----

DISPLAY

The following columns are displayed:

<LINE #> <I> <H> <M> <S> <ADDRES> <DATA> <FC> <MNEMONIC> <OPERAND>

In which:

- <I> = Interrupt signals
- <H> = Halt signals
- <M> = Mode of operation
- <S> = Status signals

Opcodes are sampled by clock0 thus the mnemonics are displayed behind this Clock.

Interrupts will be recognized; behind the interrupt opcode is shown which IPL lines have been activated.

DMA activity is not sampled.

FREE POD

POD#0 is not used for disassembly purposes.

This Pod can be used to display additional data if required.

The desired connections can be made in the interface block, refer to Fig. 9.6.

DETAILED DISPLAY INFORMATION

<LINE #> Decimal line number (-1023..1023)

<I>	Interrupt signals	
	<IPL2, IPL1, IPL0>	Interrupt level
	----- -----	
	0	7
	1	6
	2	5
	3	4
	4	3
	5	2
	6	1
	7	0 (= no interrupt)

*** 68000 *** (cont'd)

<H>	Halt signals	
	<BERR, HALT>	Description
	-----	-----
	0	BERR and HALT active
	1	HALT active
	2	BERR active
	3	No halt instruction
<M>	Mode of operation	
	<R/W, UDS, LDS>	Description
	-----	-----
	0	WRITE (word)
	1	WRITE (upper-byte)
	2	WRITE (lower-byte)
	3	
	4	READ (word)
	5	READ (upper-byte)
	6	READ (lower-byte)
<S>	Status signals	
	<FC2, FC1, FC0>	Description
	-----	-----
	0	(unassigned)
	1	User data
	2	User programm
	3	(unassigned)
	4	(unassigned)
	5	Supervisor data
	6	Supervisor programm
	7	Interrupt acknowledge
<ADDRESS>	Hexadecimal address	<A23..A0> -> 16 Mega-bytes
<DATA>	Hexadecimal data	<D15..D0>
<FC>	Function codes	
	<FC2, FC1, FC0>	Description
	-----	-----
	UF	(unassigned)
	UD	User data
	UP	User Programm
	UF	(unassigned)
	UF	(unassigned)
	SD	Supervisor data
	SP	Supervisor programm
	IA	Interrupt acknowledge
<MNEMONIC>	Opcode compilation	
<OPERAND>	0, 1 or 2 <operand-part>	separated by a comma.

INSTALLATION INSTRUCTIONS
FOR OPTIONS

INSTALLATION INSTRUCTIONS

CONTENTS:

- 10.1 Unit identifier switch (version I only)
- 10.2 Additional 24-state analyzer
PM 8851/50
- 10.3 8-channel 50 MHz timing analyzer
PM 8851/30
- 10.4 Option board, disas and non-volatile memory.
PM 8851/xx, PM 8850/xx

This chapter describes how to install the optional units in the PM 3551 Logic Analyzer. After building-in, check the function of the option according to the description of the menus and the data displays (chapter 4 and 5).

10.1

*** UNIT IDENTIFIER SWITCH ***

This information applies to PM 3551's Version I only.

The unit identifier switch informs the micro processor about the units present in the PM 3551.

In Version II models this switch is no longer present; the unit identification works then automatically.

The switch setting is dependent on the units present in the PM 3551. If the unit contents of an instrument has been changed the switch setting must be adapted accordingly. See below.

The unit identifier switch is an 8-section DIL switch, located on unit S 15-1 and can be reached after removing of the top cabinet plate.

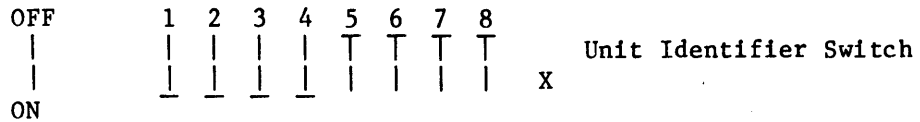

Section 1: Always in lower position.

Section 2: If S 15-3 present: in lower position.
 If S 15-3 not present: in upper position.

Section 3: If T 50-1/2 present: in lower position.
 If T 50-1/2 not present: in upper position.

Section 4: If OPT present: in lower position
 If OPT not present: in upper position

Sections 5--8: Not used; the position is not important.

PM 8851/50

= S 15-3 + 3 PM 8821 PODS

ADDITIONAL 24-CHANNEL STATE FOR ANALYZER PM 3551/10/30

*** INSTALLATION INSTRUCTIONS ***

These instructions describe how to install S 15-3 in the Logic Analyzer PM 3551. The S 15-3 features an extra 24 channels for the State Analyzer, obtaining a total of 59 State Analyzer channels. This unit can be built into the PM 3551/10 and PM 3551/30, changing the type numbers to PM 3551/50 and PM 3551/70 respectively.

Proceed as follows:

- Disconnect the instrument from the mains.
- Remove the upper and the bottom cabinet plates. Rotate the quick-fasteners only slightly, to prevent them falling apart.
- Remove the panel section which closes the gap for S 15-3 at the rear. Refer to the unit location plate at the rear of the instrument.
- Remove carefully the S 15-1 and S 15-2 assembly. Check for internal interconnection cables.
- Mount the S 15-3 p.c. board onto the S 15-1 and S 15-2 assembly. Remove the six screws from the S 15-2 board. Mount the six spacers (included in the PM 8851/50) in the freed holes. Check the plug connections between the boards. Use the six screws to mount the S 15-3.
- Carefully bend the four orange capacitors located on S 15-3 near the mother board connector somewhat downwards, to prevent that they are damaged when the unit is shifted into the instrument.
- Carefully insert the obtained assembly into the cabinet. Check that the shifting assembly does not touch the Proms on the memory extension board. Check the correct aligning of the mother board connectors and press the units firmly to the correct position.
- At the right-hand side of the instrument, on the S 15-1 board, you will find the unit-identifier switch (8 section DIL switch). Set section 2 of this switch to the lower position. For full information on this switch refer to publication 9499 500 11911.
- Connect the instrument to the mains voltage and switch on. If the instrument is not working properly, switch off, and check the mother board connector contacting.
- Mount the cabinet plates. Connect the three PM 8821 Pods.

PM 8851/30

= T 50-1+2 + PM 8825 POD

8-CHANNEL 50 MHz TIMING ANALYZER FOR ANALYZER PM 3551/10/50

*** INSTALLATION INSTRUCTIONS ***

Introduction

These instructions describe how to install the unit T 50-1+2 in the Logic Analyzer PM 3551. This unit consists of two p.c. boards, mounted together and features eight 50MHz timing channels.

The unit can be built into the PM 3551/10 and PM 3551/50, changing the type numbers to PM 3551/30 and PM 3551/70 respectively.

-Note that there are two possibilities for the input of POD 0 channels of the resident State Analyzer:

A. POD 0 input of the State Analyzer is internally connected with the input (POD 0T) of the Timing Analyzer.

B. POD 0 input of the State Analyzer has his own Pod input.

The difference is that with A, eight channels are combined for the State- and the Timing Analyzer (double probing is prevented).

With B the inputs of both analyzers are fully separated.

The SYNC or COMBI modes function independently of both possibilities. (The standard delivery of the PM 3551/30 and -/70 Analyzers is according to the A possibility).

-The installment of the Timing Analyzer includes modification of the secondary board of the power supply unit.

Proceed as follows:

-Disconnect the instrument from the mains.

-Remove the upper and bottom cabinet plates. Rotate the quick-fasteners only slightly, to prevent them falling apart.

-Lift the fan assy located over the power supply unit.

Remove the secondary supply unit. This is the unit located at the inner side in the power supply compartment.

Short circuit the diodes V1265 and V1266 by soldering two wires as indicated in Fig. 2. These diodes must be short-circuited to compensate for the voltage drop caused by the increased current consumption, refer to Fig. 1. (The current consumption amounts to 14 Amps approx.).

Mount the secondary supply unit again.

Mount the fan assy again.

- Remove the panel section which closes the gap for T 50-1+2 at the rear.
Refer to the unit location plate at the rear of the instrument.
- Remove the state analyzer from the instrument.
If your state analyzer has been provided with 59 channels, unit S 15-3 must be temporarily removed from the state analyzer assy.
Connect the two coax cables between the timing analyzer and unit S 15-2 of the state analyzer as indicated in Fig. 3.
While doing this, the units must be partly shifted into the instrument.
Right from T 50-2, these cables pass downwards through the p.c. board sliding frame, (laying underneath the sliding frame) and pass upwards just before S 15-2.
The longer cable connects X512--X908.
Remount unit S 15-3 if present.
- Carefully insert the units in the cabinet.
Check for correct alignment of the motherboard connectors and press the units firmly to the correct position.
- Possibility A or B?
 - A. Connect the 16-pole flat cable (included in delivery) between T 50-2 and S 15-2. Refer to Fig. 3.
This cable interconnects both the POD 0 input and the POD OT input.
Means must be taken to prevent that the two Pods could be connected to the instrument at the same time.
This could be done by:
 - removing the POD 0 input connector from unit S 15-2, or
 - closing the POD 0 input connector with a cap or bracket.
 - B. Do not mount the flat cable. (Both POD 0 and POD OT inputs can be used at the same time).
- At the right-hand side of the instrument, on the S 15-1 board, you will find the unit-identifier switch (8 section DIL switch).
Set section 3 of this switch to the lower position.
For full information on this switch refer to publication 9499 500 11911.
- Connect the instrument to the mains voltage and switch on.
If the instrument is not working properly, switch off, and check the mother board connector contacting.
Connect the Pods and check the function of the SYNC mode. (Refer to the Operating Manual).
If under the timing display the message NO SYNC POSSIBLE with (1) or (2) is shown, check the connections of the two coax cables.
- Mount the cabinet plates.

Enclosed drawings:

- Fig. 10.3.1 Circuit diagram secondary power supply.
- Fig. 10.3.2 P.c. board secondary power supply.
- Fig. 10.3.3 Connections between T 50-1 and S 15-2.

April 19, 1983

Fig. 10.3.1 Circuit diagram secondary power supply.

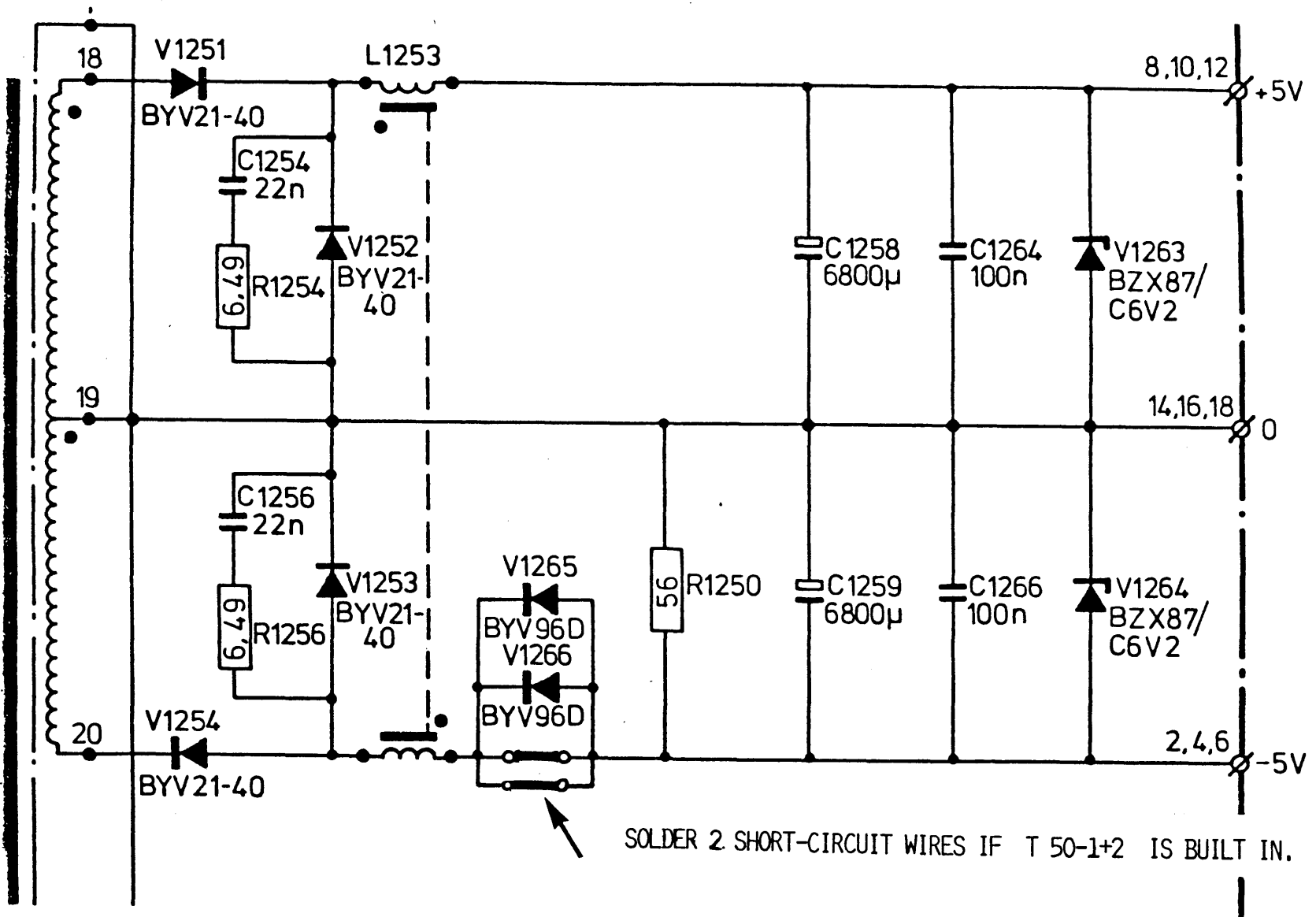

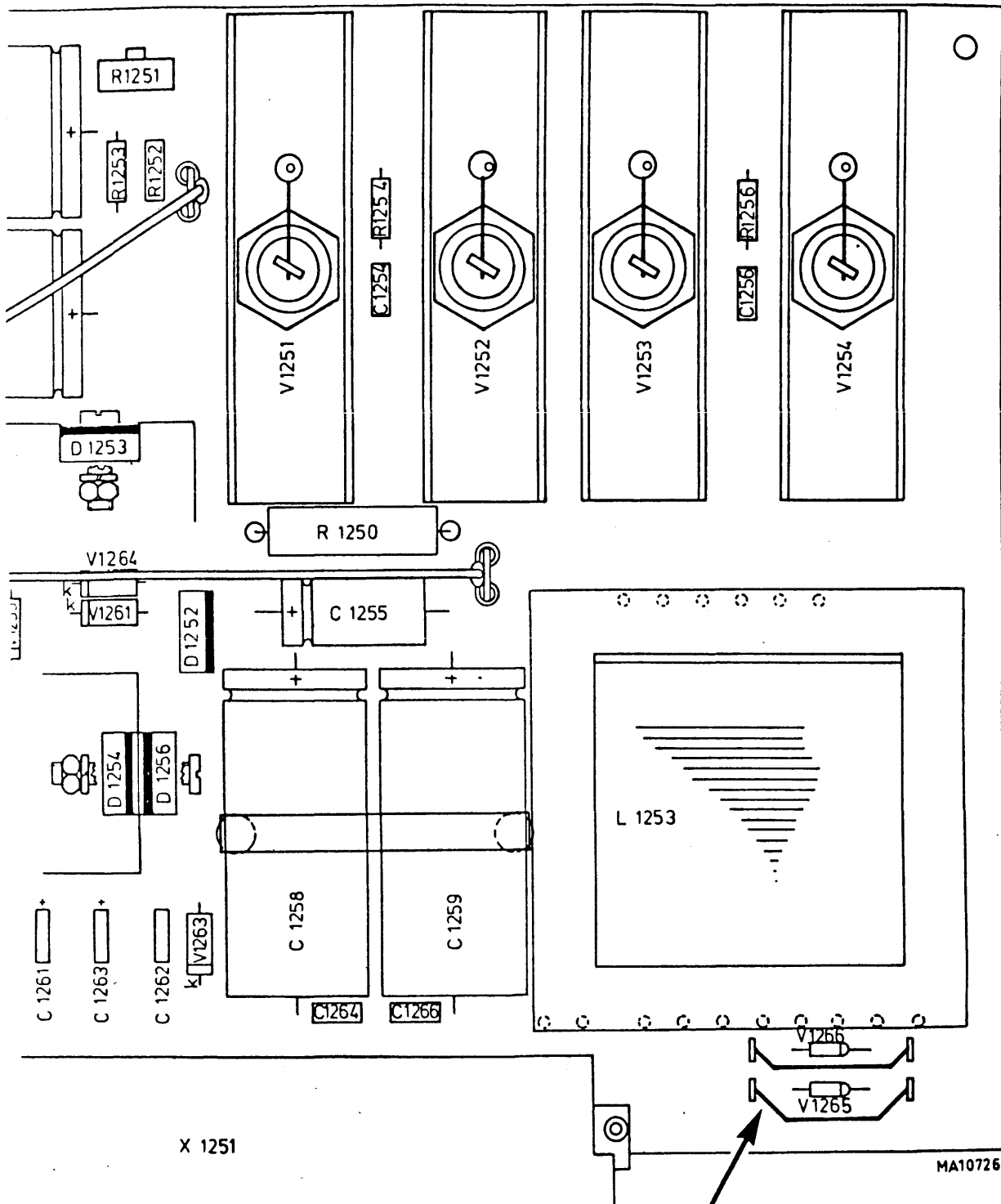

SOLDER 2 SHORT-CIRCUIT WIRES IF T 50-1+2 IS BUILT IN.

Fig. 10.3.2 P.c. board secondary power supply.

April 19, 1983

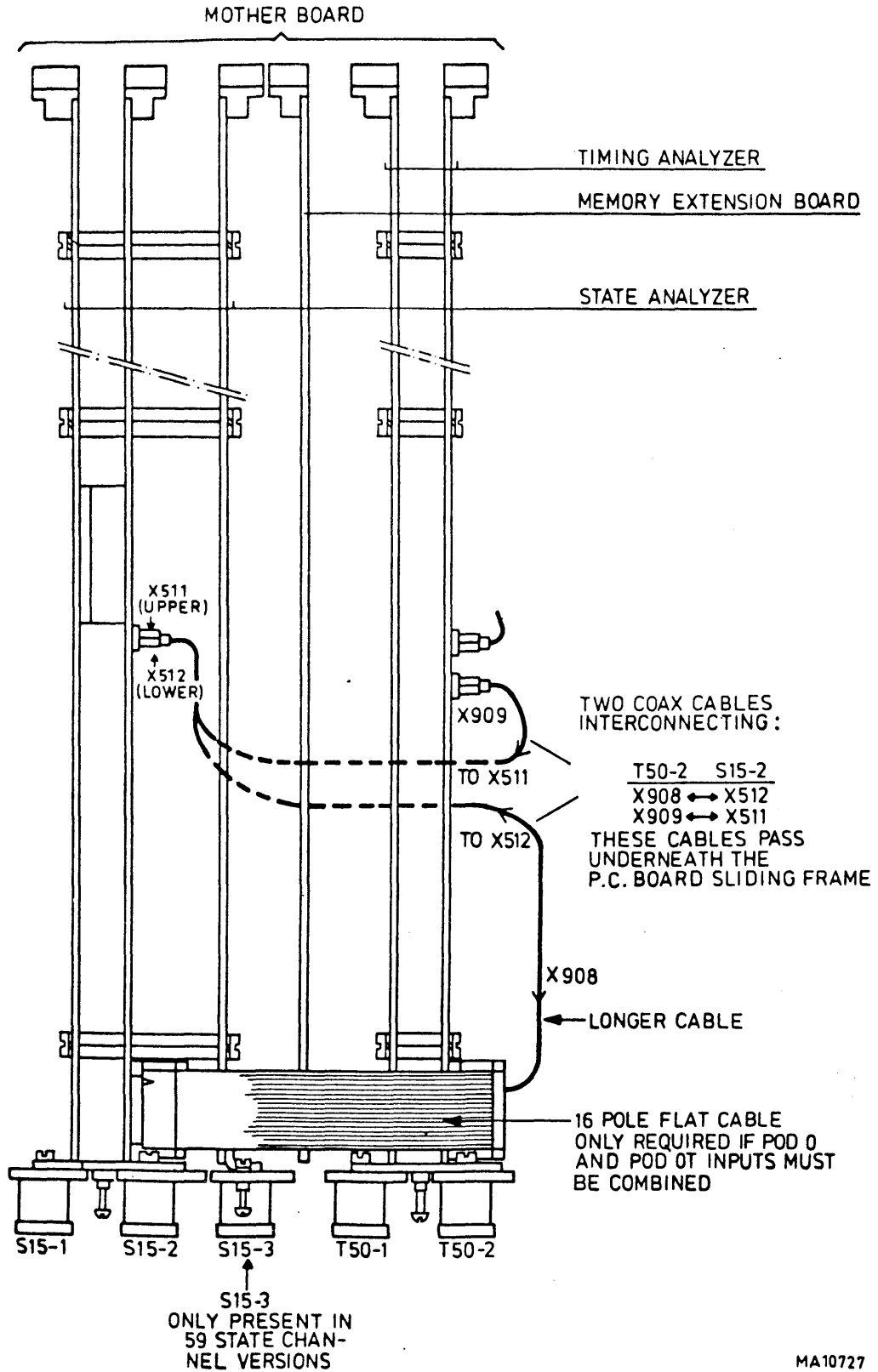

MA10727

Fig. 10.3.3 Connections between T 50-1 and S 15-2

OPTIONS BOARDS FOR LOGIC ANALYZER PM 3551

PM 8851/00= Options board with printer output.

/20= The same as -/00 but with additional RS 232C control interface.

/40= The same as -/00 but with additional IEEE 488 (IEC 625) control-
interface.

*** INSTALLATION INSTRUCTIONS ***

1.Options Board (OPT-1).

Proceed as follows:

- Disconnect the instrument from the mains.
- Remove the upper cabinet plate. Rotate the quick-fasteners only slightly, to prevent them falling apart.
- Remove the panel section which closes the gap for the options board at the rear.
Refer to the unit location plate at the rear of the instrument.
- Carefully shift the options board into the cabinet.
Check the correct aligning of the mother board connector and press the option board firmly to the correct position.
- Version I instruments:
At the right-hand side of the instrument, on the S 15-1 board, you will find the unit-identifier switch (8 section DIL switch).
Set section 4 of this switch to the lower position.
For full information on this switch refer to chapter 10.1
- Version II instruments:
Unit identification is done automatically.
- Connect the instrument to the mains voltage and switch on.
The options menu must now be selectable.
If the instrument is not working properly, switch off, and check the mother board connector contacting.
- Mount the cabinet plate.

2.Disa's and non-volatile memory

- Remove the option board.
- The disa's and non-volatile memory can be mounted as indicated in Fig. 10.4.1.
Up to four disa boards can be built-in. There is no specific place for a specific disa board.
Check the correct position and use the supplied mounting material.
- Mount the option board in the instrument.

Fig. 10.4.1 Location of disa boards and non-volatile memory board.

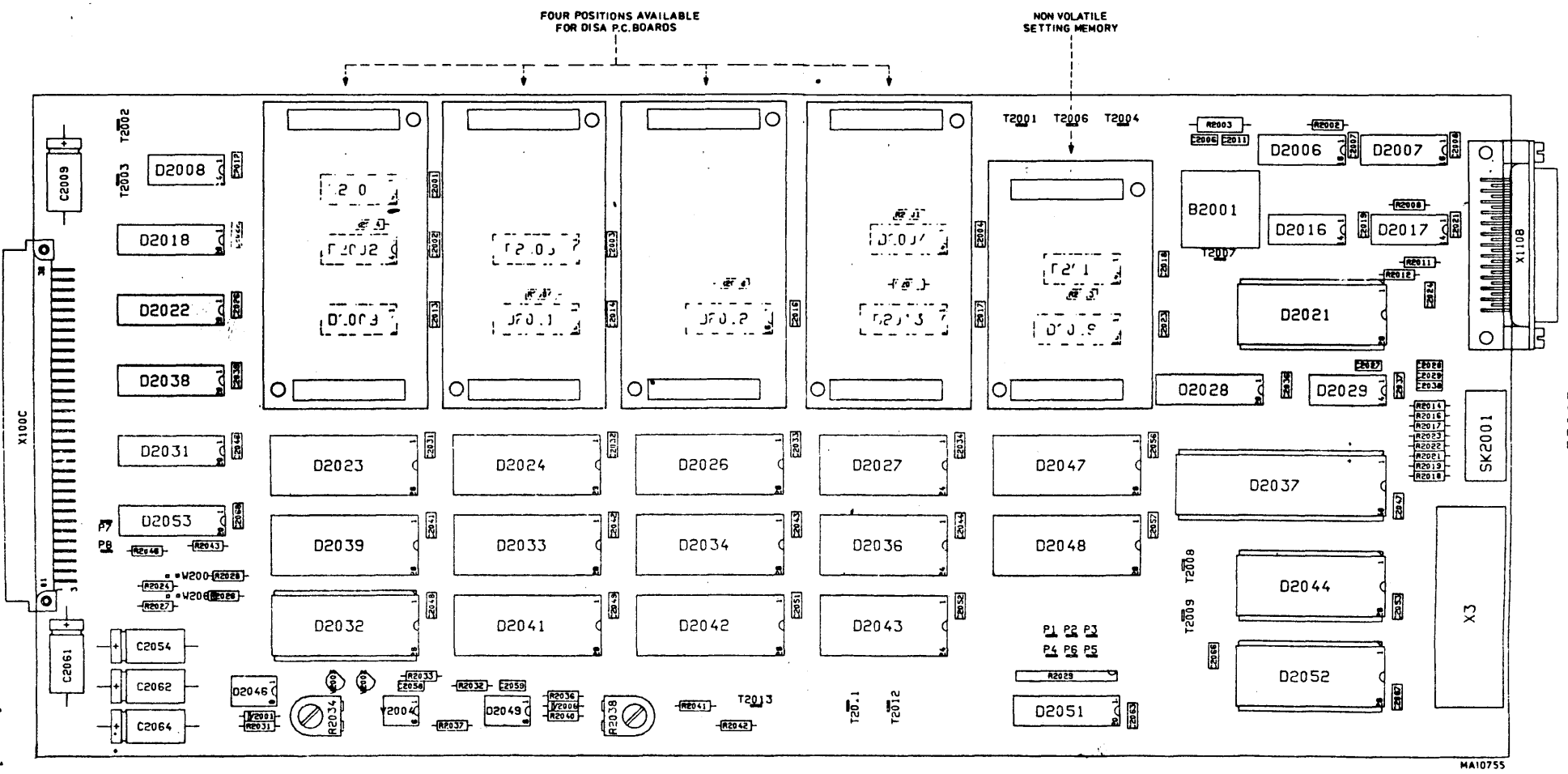

PROBLEM REPORTS
AND CHANGE REQUESTS

11. PROBLEM REPORTS AND CHANGE REQUESTS

In the back of this manual you find some Problem Reports/Change Request forms.

INTRODUCTION

This dual purpose form can be used as either a Problem Report form, or as a Change Request form, but not for both at the same time.

The form can be used as a Problem Report only when the equipment does not meet the specifications detailed in the PM 3551 Manuals, or when it cannot be repaired through normal service/repair. Alternatively, the form can be used as a Change Request to describe suggested enhancement or improvements.

Note:

Use a separate form for each Problem Report or Change Request, thus do not enter more than one subject on a form.

*Before filling in a form, either remove the three layers required per report, or place a hard paper sheet under the third layer to ensure that only the required number of sheets are copied.
These forms are carbon coated, therefore no additional carbon paper is required.

->

INSTRUCTIONS FOR COMPLETING

<u>SECTION</u>	<u>REQUIREMENTS</u>
PURPOSE:	Indicate the type of report with a cross in the appropriate box.
PRIORITY:	Indicate the suggested priority with a cross in the appropriate box.
SUBMITTED BY:	Fill in full name and address, because the yellow copy will be returned for acknowledgement of reception of the form while using window envelopes. Therefore use a typewriter, or write capitals using a ballpoint pen. Write only on the dotted lines. Do not forget your telephone and telex number.
DESCRIPTION:	Give a complete description of the problem or suggested modification.
ATTACHED MATERIALS	Do not forget to indicate whether or not you have attached diskettes, listings or other documents. Attachments are very useful for quick responses because it gives details of the problem.
AFFECTED HW/SW (Hardware/Software)	Please give the requested details of the relevant HW/SW configuration. It helps us to judge whether an update may be required, or not.
PHILIPS USE ONLY	These boxes are completed by the T&M Service Dept. Eindhoven. The yellow copy will be returned with the PR- or CR number, date of reception, etc.

After completion, mail the entire set, top form plus copies to the mailing address listed at the bottom of the form.

CHANGE REQUEST/PROBLEM REPORT

9499 620 02011

ORIGINATOR
 Name:
 Company:
 Address:
 Telex: Phone Number: Date Submitted: / /

PHILIPS USE ONLY
 PR Number :
 CR Number :
 Date Received: / /

PURPOSE To report a problem To make a change request

CONFIGURATION REVIEW	TYPE	SERIAL No.	RELEASE/VERSION	12NC No.
Hardware: Main System Debug Unit Peripherals				
PC Boards				
Others.....				
Software: Monitor CCI Debugger				
Others.....				

PRIORITY Very Urgent Urgent Routine Low Priority

PROBLEM DESCRIPTION OR DETAILS OF CHANGE REQUESTED: (Please include a log of console I/O when possible)

ENCLOSED: Dump Listing Console Log Target System Description Source Listing Program Listing
 Other:

ANALYSIS	Result of		Remarks	<u>PHILIPS USE ONLY</u>
	Screening	Maint'		
Date				
Employee				
Hardware Error	<input type="checkbox"/>	<input type="checkbox"/>		
Doc. Error	<input type="checkbox"/>	<input type="checkbox"/>		
User Error	<input type="checkbox"/>	<input type="checkbox"/>		
More Info Req'	<input type="checkbox"/>	<input type="checkbox"/>		
Same as	<input type="checkbox"/>	<input type="checkbox"/>		
Solved by			in rel':	
Softw. corr.	<input type="checkbox"/>	<input type="checkbox"/>		
By pass	<input type="checkbox"/>	<input type="checkbox"/>	telex, phone, express, courier	

Analysis - By pass - Proposed Solution - Correction - General Remarks

Documents affected:	Element No.	Document No.	Title:
	Element No.	Document No.	Title:

External Documents Affected: (Manuals , etc):

Planning Consequences:

Estimated Influence on SSP:

Estimated Cost of Implementation:



Mailing address: Mr. B. HUIJBERS - Service Manager - Test & Measuring
 N.V. PHILIPS' GLOEILAMPENFABRIEKEN
 Building TQ V-2 - 5600 MD Eindhoven - The Netherlands

